

LCD Digital Camera

# ***QV-2000UX/1r***

User s Guide

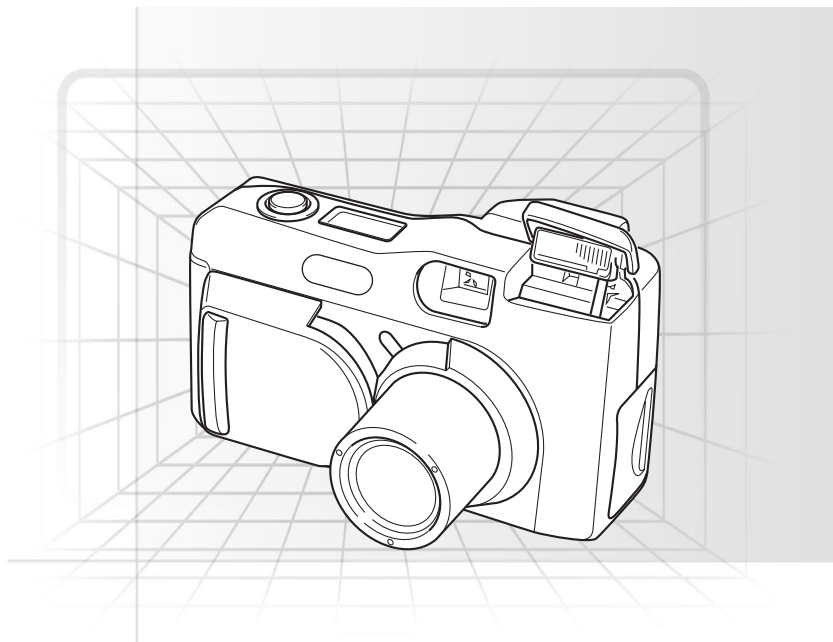

English

**CASIO®**

# QUICK REFERENCE

The section provides a general outline of operational procedures.

## Loading Batteries (page E-35) Setting the Current Date and Time (page E-41)

1

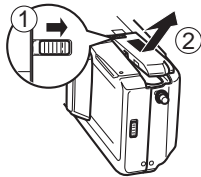

On the bottom of the camera, slide the battery compartment cover lock towards the front of the camera (①) to release the cover.

Grasping both sides of the battery compartment cover, swing it open (②).

2

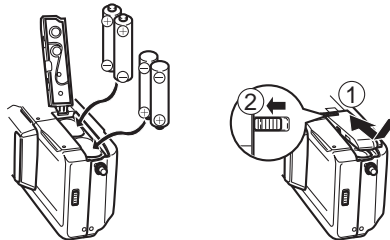

Load batteries so their plus (+) and minus (-) ends are facing as shown in the illustration.

Close the battery compartment cover (①), and then slide the battery compartment cover lock towards the back of the camera to lock the cover in place (②).

3

- Be sure to use the procedure on page E-41 to set the time and date before using the camera for the first time.
- File name assignment and time stamping will not be performed correctly if the time and date are wrong.

# QUICK REFERENCE

## Recording Images (page E-43)

2

After composing the image on the monitor screen, press the shutter button about half way and hold it there.

- The camera's Auto Focus feature automatically focuses the image.

1

Slide open the lens cover.

- Sliding open the lens cover part way initially causes the flash to pop up. Sliding it the rest of the way open turns on camera power and allows the lens to extend from the camera body. Be sure to slide the lens cover open as far as it will go.

3

After confirming that the Auto Focus operation is complete (the operation lamp lights green), press the shutter button.

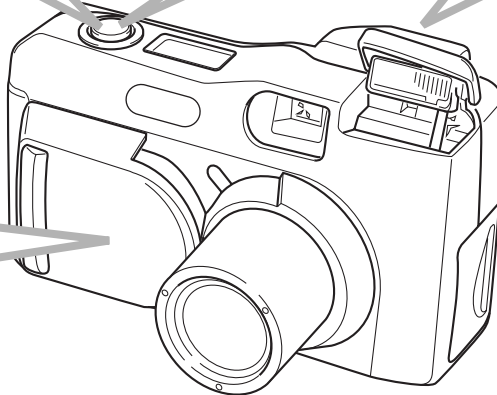

# QUICK REFERENCE

## Playing Back Images (page E-75)

2

Use [▶] and [◀] to scroll through the images stored in camera memory.

1

**Press PLAY ON / OFF.**

- This turns on power and displays recorded images on the monitor screen. Pressing PLAY ON/OFF in the Record Mode switches to the Playback Mode.

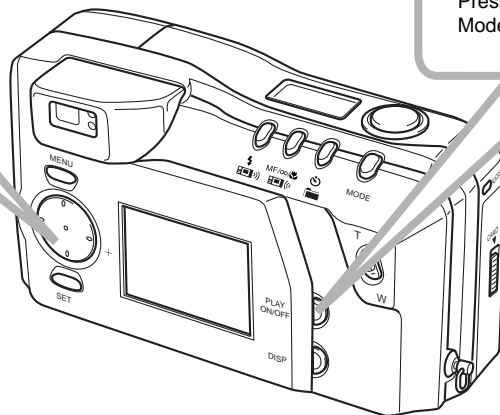

# QUICK REFERENCE

## Deleting Images (page E-88)

**3**

Use [▶], [◀], [▼] and [▲] to select “Delete”, and then press SET.



Use [▼] and [▲] to select “Select”, and then press SET.



Use [▶] and [◀] to select the image you want to delete. Next, press [▼] or [▲] to toggle the  mark on (delete) or off (do not delete).

- Note that the first time you display an image its  icon is turned on.

**2**

Press MENU.

**4**

Double check to make sure that you really want to delete the image you selected.

- Press MENU to exit the image delete operation.

**1**

Press PLAY ON/OFF.

**5**

Press SET.

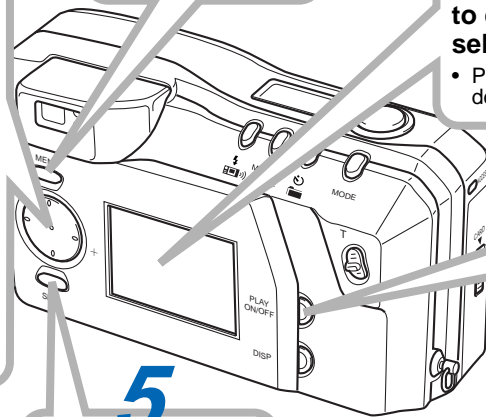

# CONTENTS

## INTRODUCTION

Congratulations upon your selection of the QV-2000UX/Ir LCD Digital Camera.

To get the most out of the QV-2000UX/Ir, be sure to carefully read this manual and follow the instructions contained in it.

### **E-2** QUICK REFERENCE

### **E-9** FEATURES

### **E-14** PRECAUTIONS

### **E-18** UNPACKING

Attaching the Strap ..... E-19

Using the Soft Case ..... E-20

### **E-21** GENERAL GUIDE

Lens ..... E-21

Top and Display ..... E-22

Side ..... E-23

Bottom ..... E-23

### **E-26** MONITOR SCREEN

Recording Mode ..... E-26

Indicator display ..... E-28

Playback Mode ..... E-28

Menu Screens ..... E-29

### **E-31** MEMORY CARDS

Inserting a Memory Card into the Camera ..... E-31

Removing a Memory Card from the Camera ..... E-32

Formatting a Memory Card ..... E-33

### **E-35** POWER SUPPLY

Loading Batteries ..... E-35

Using AC Power ..... E-38

Power Save Settings ..... E-39

### **E-41** SETTING THE CURRENT DATE AND TIME

Setting the Date and Time ..... E-41

Selecting the Date Format ..... E-42

### **E-43** RECORDING

Turning on Camera Power ..... E-43

Turning Off Camera Power ..... E-43

Using the Shutter Button ..... E-44

Basic Recording Operation ..... E-45

Using the Viewfinder for Recording ..... E-47

Using Focus Lock ..... E-48

Using the Flash ..... E-49

Quality Settings ..... E-51

Exposure Compensation ..... E-52

### **E-54** OTHER RECORDING FUNCTIONS

Using Quick Shutter ..... E-54

Continuous Recording ..... E-55

Using the Zoom Features ..... E-56

Manual Focus ..... E-57

Infinity Mode Recording ..... E-58

Using the Macro Mode ..... E-58

Movie Recording ..... E-59

Panorama Recording ..... E-61

Night Scene Mode ..... E-62

Landscape Mode Recording ..... E-63

Monochrome and Sepia Recording ..... E-64

Portrait Recording .....	E-65
Using the Self-timer .....	E-65
Shutter Speed Priority Image Recording .....	E-66
Aperture Priority Image Recording .....	E-67
Performing Manual White Balance .....	E-68
Recording Mode Power On Settings .....	E-69
Using the Record Menus .....	E-71

**E-75 PLAYBACK**

Basic Playback Operation .....	E-75
Playing Back a Movie .....	E-76
Panorama Playback .....	E-77
Using Zoom .....	E-78
Displaying Nine Images .....	E-79
Slide Show .....	E-80
Screen Saver .....	E-81
Using the Playback Menus .....	E-82

**E-84 FOLDER TYPES**

Memory Card Folder Precautions .....	E-84
Selecting a Folder for Playback .....	E-85

**E-86 IMAGE PROTECTION**

Protecting and Unprotecting a Single Image .....	E-86
Protecting and Unprotecting Folders .....	E-87
Protecting and Unprotecting All Images on a Memory Card .....	E-87

**E-88 DELETING IMAGES**

Deleting a Single Image .....	E-88
-------------------------------	------

Deleting All the Images in a Folder .....	E-89
Deleting All Unprotected Images .....	E-90

**E-91 DPOF**

Printing Specific Images .....	E-91
Printing All the Images in a Folder .....	E-92
Printing All Images .....	E-93

**E-94 CONNECTIONS**

**E-95 CONNECTING TO OTHER EQUIPMENT**

Connecting to a Television .....	E-95
Connecting to a Computer .....	E-96

**E-99 INFRARED DATA TRANSFER**

Receiving Data .....	E-99
Sending Data .....	E-100

**E-102 USING CompactFlash CARDS WITH YOUR COMPUTER**

Setting Up to Access CompactFlash Card Contents From Your Computer .....	E-102
Memory Card Data .....	E-103
Card Browser .....	E-105

**E-111 TROUBLESHOOTING**

**E-115 MESSAGES**

**E-117 SPECIFICATIONS**

- CASIO COMPUTER CO., LTD. assumes no responsibility for any damage or loss resulting from the use of this manual.
- CASIO COMPUTER CO., LTD. assumes no responsibility for any loss or claims by third parties which may arise through the use of the QV-2000UX/Ir.
- CASIO COMPUTER CO., LTD. assumes no responsibility for any damage or loss caused by deletion of data as a result of malfunction, repairs, or battery replacement. Be sure to back up all important data on other media to protect against its loss.
- *Windows and Internet Explorer are registered trademarks of Microsoft Corporation.*
- *Macintosh is a registered trademark of Apple Computer, Inc.*
- *COMPACTFLASH™ and  logo are registered trademarks of SanDisk Corporation.*
- *Other company, product and service names used herein may also be trademarks or service marks of others.*
- *The USB driver uses software by Phoenix Technologies Ltd.  
Compatibility Software Copyright © 1997  
Phoenix Technologies Ltd., All Rights Reserved.*
- *IrDA communications use Phoenix Technologies Ltd. protocol software.  
Compatibility Software Copyright © 1997  
Phoenix Technologies Ltd., All Rights Reserved.*



# FEATURES

## Continuous recording (page E-55)

Continuous recording of high-quality images at 0.5-second intervals is just like have a motor drive on the camera.

## DCF Data Storage (page E-103)

DCF (Design rule for Camera File system) data storage protocol provides image inter-compatibility between the digital camera and printers.

## Digital Print Order Format (DPOF) (page E-91)

Images can be easily printed in the sequence you want using a DPOF compatible printer. DPOF can also be used by professional print services when specifying images to produce prints.

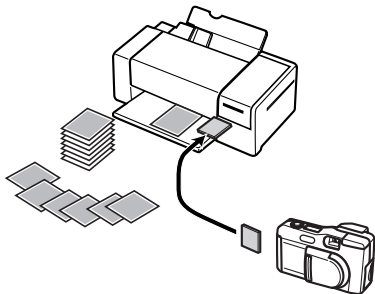

## Simple image management (page E-105)

Images are stored on a large-capacity CompactFlash memory card. A new Card Browser feature produces thumbnails of all images on a card quickly and easily.



### Movie and panorama images (pages E-76, 77)

A buffer lets you capture images of events that occurred before you pressed the shutter button.

A built-in function lets you combine up to nine images into breathtaking panoramas.

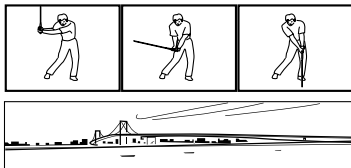

### Easy-to-understand graphic interface (page E-26)

All camera operations can be performed on graphic based interactive menu screens. CASIO high-resolution HAST LCD makes screen images clearer and more colorful than ever before.

### CASIO original metering system

Light metering includes innovative multi-pattern metering.

### Megapixel CCD

Images are recorded by a 2.11-megapixel CCD for amazing resolution and clarity.

Some slight image noise may be caused when using slow shutter speeds.

### Easy connection to other devices (page E-94)

USB, DIGITAL, and VIDEO OUT terminals provide easy connection to other devices.

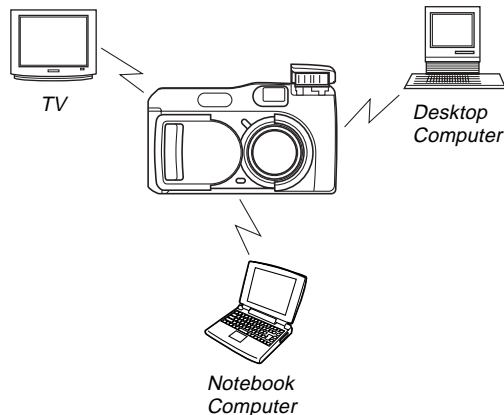

6X zoom is produced using 3X optical zoom together with 2X digital zoom.

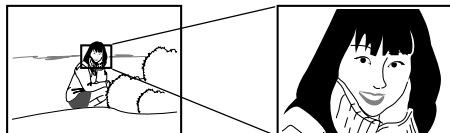

page E-56

Macro Feature

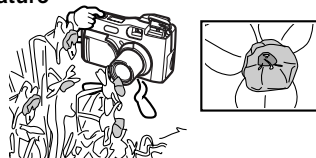

page E-57

Landscape Mode

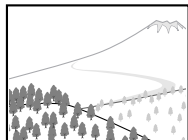

page E-63

Portrait Mode

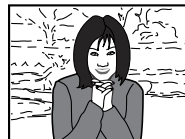

page E-65

Night Scene

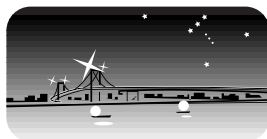

page E-62

Shutter Speed Priority (S Mode)



page E-66

Aperture Priority (A Mode)

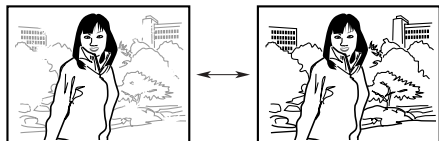

page E-67

9-image Screen



page E-79

Self-timer



page E-65

Slide Show



page E-80

Date and Time Stamping

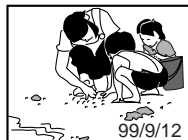

page E-41

Display Zoom

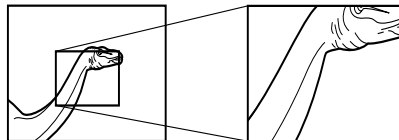

page E-78

**Image Protection**

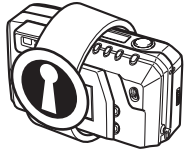

page E-86

# PRECAUTIONS

## General Precautions

Be sure to observe the following important precautions whenever using the QV-2000UX/Ir.

All references in this manual to “this camera” and “the camera” refer to the CASIO QV-2000UX/Ir Digital Camera.

- Never try to take pictures or use the built-in display while operating a motor vehicle or while walking. Doing so creates the danger of serious accident.
- Never try to open the case of the camera or attempt your own repairs. High-voltage internal components create the risk of electrical shock when exposed. Always leave maintenance and repair work up to authorized CASIO service providers.
- Never fire the flash in the direction of a person operating a motor vehicle. Doing so can interfere with the driver's vision and create the danger of accident.
- Never fire the flash while it is too close to the subject's eyes. Intense light from the flash can cause eye damage if it is fired too close to the eyes, especially with young children. When using the flash, the camera should be at least one meter from the eyes of the subject.
- Keep the camera away from water and other liquids, and never let it get wet. Moisture creates the danger of fire and electrical shock. Never use the camera outdoors in the rain or snow, at the seashore or beach, in the bathroom, etc.

- Should foreign matter or water ever get into the camera, immediately turn power off, unplug the AC adaptor from the power outlet, and contact your dealer or nearest CASIO service provider. Using the camera under these conditions creates the danger of fire and electrical shock.
- Should you ever notice smoke or a strange odor coming out of the camera, immediately turn power off and unplug the AC adaptor from the power outlet. Using the camera under these conditions creates the danger of fire and electrical shock. After making sure there is no more smoke coming from the camera, take it to your nearest CASIO service provider for repair. Never attempt your own maintenance.
- At least once a year, unplug the AC adaptor from the power outlet and clean the area around the prongs of the plug. Dust build up around the prongs can create the danger of fire.
- If the camera's case should ever become cracked due to dropping it or otherwise subjecting it to rough treatment, immediately turn power off, unplug the AC adaptor from the power outlet, and contact your nearest CASIO service provider.
- Never use the camera inside of an air craft or in any other areas where its use is prohibited. Doing so can result in an accident.
- Physical damage and malfunction of this camera can cause the image data stored in its memory to be deleted. Be sure to always keep backup copies of data by transferring them to personal computer memory.

- Never open the battery compartment cover, disconnect the AC adaptor from the camera or unplug it from the wall socket while recording images. Doing so will not only make storage of the current image impossible, it can also corrupt other image data already stored in camera memory.

## Operating conditions

- This camera is designed for use in temperatures ranging from 0°C to 40°C.
- Do not use or keep the camera in the following areas.
  - In areas subject to direct sunlight
  - In areas subject to high humidity or dust
  - Near air conditioners, heaters, or other areas subject to temperature extremes
  - Inside of a closed vehicle, especially one parked in the sun
  - In areas subject to strong vibration

## Condensation

- When you bring the camera indoors on a cold day or otherwise expose it to a sudden change of temperature, there is the possibility that condensation can form on the exterior or on interior components. Condensation can cause malfunction of the camera, so you should avoid exposing it to conditions that might cause condensation.
- To keep condensation from forming, place the camera into a plastic bag before moving it into a location that is much warmer or colder than your current location. Leave it in the plastic bag until the air inside the bag has a chance to reach the same temperature as the new location. If condensation does form, remove the batteries from the camera and leave the battery compartment cover open for a few hours.

## About the camera's backlight...

- The camera is equipped with a fluorescent light source to provide the back lighting for its LCD.
- The normal service life of the backlight is approximately six years, when the camera is used for about two hours a day.
- Should the LCD image appear abnormally dark, take the camera to your dealer or an authorized CASIO service provider to have the light source replaced. Note that you will be charged for this replacement.
- Under very cold conditions, the backlight may require more time than normal to light, or reddish bands may appear in the displayed image. These conditions do not indicate malfunction, and normal operation should return at higher temperatures.

## Monitor Screen

### Recording

- The image shown on the monitor screen during recording is intended for composition purposes only, so its quality does not match that of the image as it is recorded. The image is recorded in accordance with the quality setting made with the procedure under "Quality Settings" on page E-51.
- A dimly lit subject can slow down monitor screen refresh or cause static in the displayed image.

### Playback

This camera is designed for high-speed scrolling of images during playback. Because of this, the playback image that initially appears on the monitor screen does not show the full resolution of the image as recorded. When you stop at the image you want, the monitor screen refreshes and shows the image in its full resolution.



## Lens

- Camera performance can be adversely affected by fingerprints or dirt on the lens surface. Never touch the lens surface with your fingers.
- Should the lens become dirty, use a blower to blow off dirt and dust, or a soft, dry cloth to wipe off the lens.
- This camera uses a telescoping type lens, which moves whenever the camera is turned on or off. Make sure nothing is blocking lens movement and never turn power on or off while the camera is laying lens down.
- Never remove batteries or disconnect the AC adaptor while the lens is extended. Doing so can cause the lens to become stuck in the extended position, resulting in camera malfunction.

## Date Setting

No data setting is made before the camera is shipped from the factory. Be sure to use the procedure on page E-41 to set the time and date before using the camera for the first time. File name assignment and time stamping will not be performed correctly if the time and date are wrong.

# UNPACKING

Check to make sure that all of the items shown below are included with your camera. If something is missing, contact your dealer as soon as possible.

*Camera*



*Memory card (8 MB)*

Loaded in the camera when you purchase it.



*Soft case*



*CD-ROM*



*Alkaline batteries  
(AA-size x 4)*



*Strap*

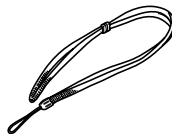

*Video cable*



*Special USB cable*



*Data Transfer Cable*

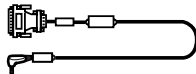

*Manual*

- Basic Reference

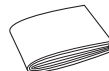

- Bundled Software User's Manual



## Attaching the Strap

Pass the wrist strap through the hole on the side of the camera as shown in the illustration.

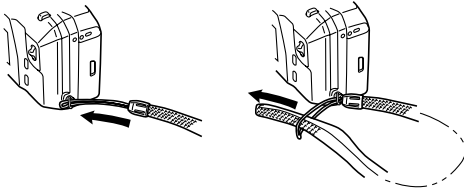

## Adjusting the Length of the Strap

Slide the stopper to adjust the length of the strap. This way you can make it a short hand strap, or a longer shoulder or neck strap.

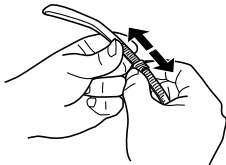

## IMPORTANT!

- Be sure to keep the strap around your wrist whenever using the camera to protect against accidentally dropping it.
- The supplied strap is intended for use with this camera only. Do not use for any other application.
- Never swing the camera around by the strap.
- Allowing the camera to swing freely from your neck can result in damage to the camera due to its bumping against other objects. It also creates the danger of the camera becoming caught in a door or on other objects, resulting in personal injury.

## Using the Soft Case

Keep the camera in its soft case to protect it when not in use.

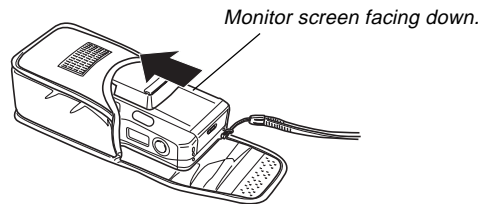

*If you pass the strap through the hole in the side of the case, you will be able to use the camera without removing it from the case.*

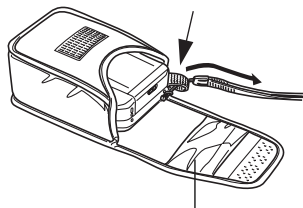

*The pocket inside the soft case can be used to store memory cards.*

# GENERAL GUIDE

The following illustrations show the names of each component, button and switch on the camera.

## Lens

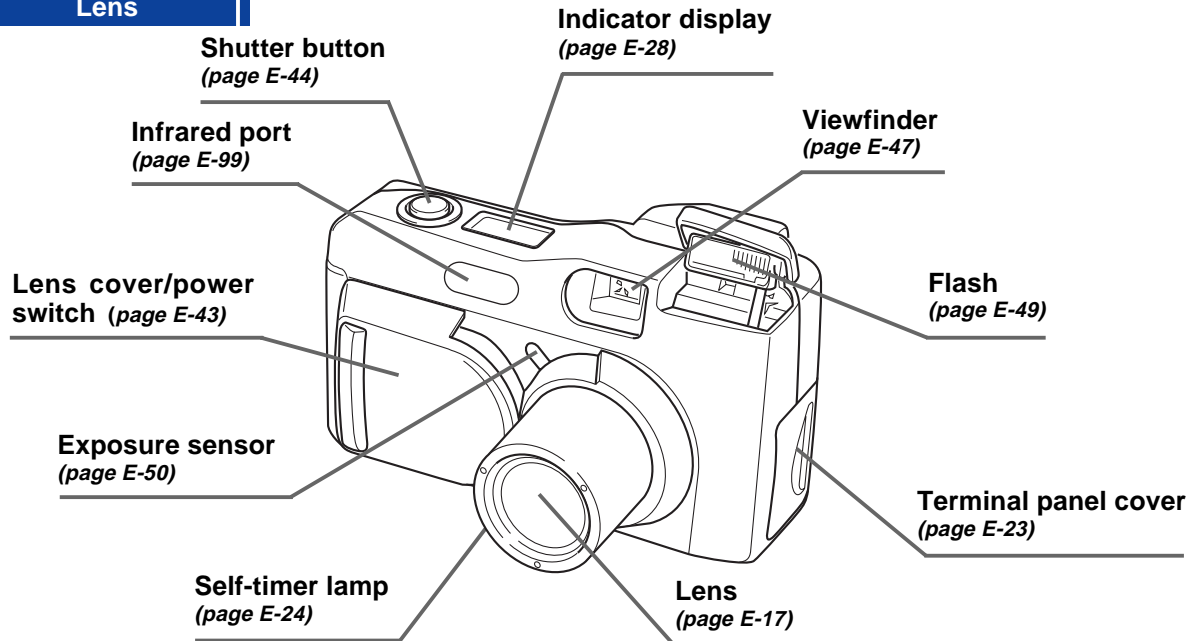

Top and Display

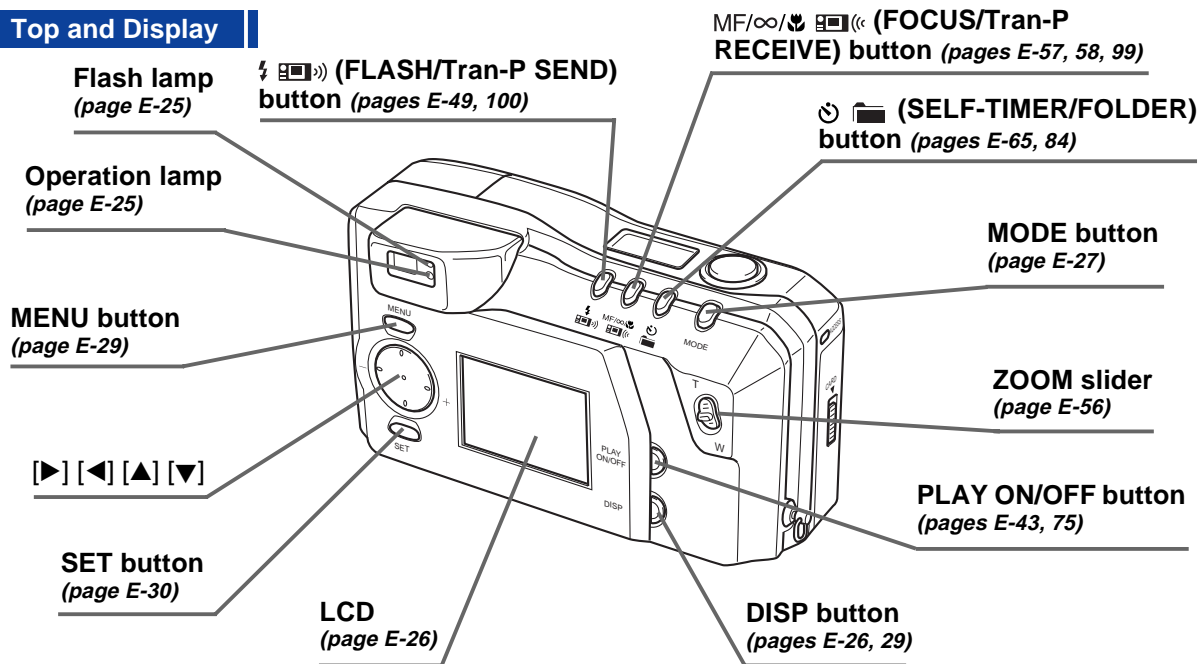

**Side**

**DIGITAL terminal**  
(page E-94)

**USB port**  
(page E-94)

**AC power terminal**  
(page E-38)

**VIDEO OUT terminal**  
(page E-94)

**Card access lamp**  
(page E-24)

**Memory card slot cover**  
(page E-31)

**Diopter dial**  
(page E-47)

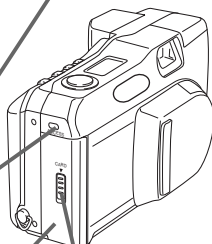
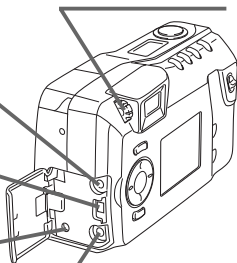

**Memory card cover lever**  
(page E-31)

**Bottom**

**Tripod screw hole**

**Battery compartment lock**  
(page E-35)

**Battery compartment cover**  
(page E-35)

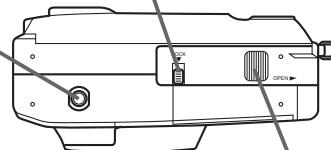

**Opening the Terminal Panel Cover**

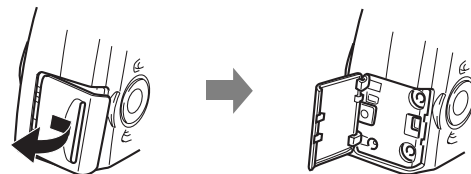

## Card access lamp

The Card access lamp flashes green while the memory card is being accessed. Never remove the memory card while the Card access lamp is flashing.

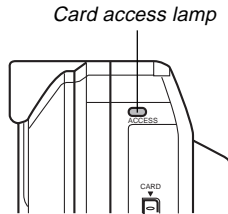

### **IMPORTANT!**

Never open the memory card cover while the card access lamp is flashing.

## Self-timer lamp

The Self-timer lamp flashes when the self-timer is performing a timer operation prior to releasing the shutter.

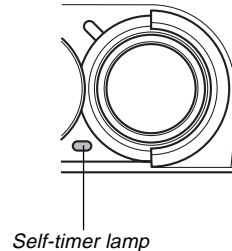



## Operation lamp

The Operation lamp shows the operational status of the camera as described below.

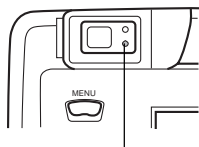

Operation lamp

### Recording Mode

Lamp Color	Flashing
Green	One of the following operations is in progress: start up, save (single or multiple), movie recording (PAST) standby

- The camera is ready to record when the lamp is off.

### Partial Shutter Button

Lamp Color	On	Flashing
Green	Auto focus operation complete.	Auto focus operation failed.

## Flash lamp

The Flash lamp also lights and flashes during a record operation as described below.

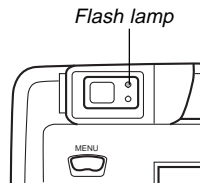

### Recording Mode

Lamp Color	Flashing
Amber	Flash is charging.

### Partial Shutter Button

Lamp Color	On
Amber	Ready to fire.

- When the Operation lamp and Flash lamp are both flashing, an error message appears on the monitor screen, regardless of whether the monitor screen is turned on or off.

# MONITOR SCREEN

Pressing DISP causes various indicators to appear on the monitor screen.

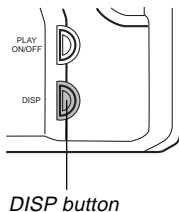

## Recording Mode

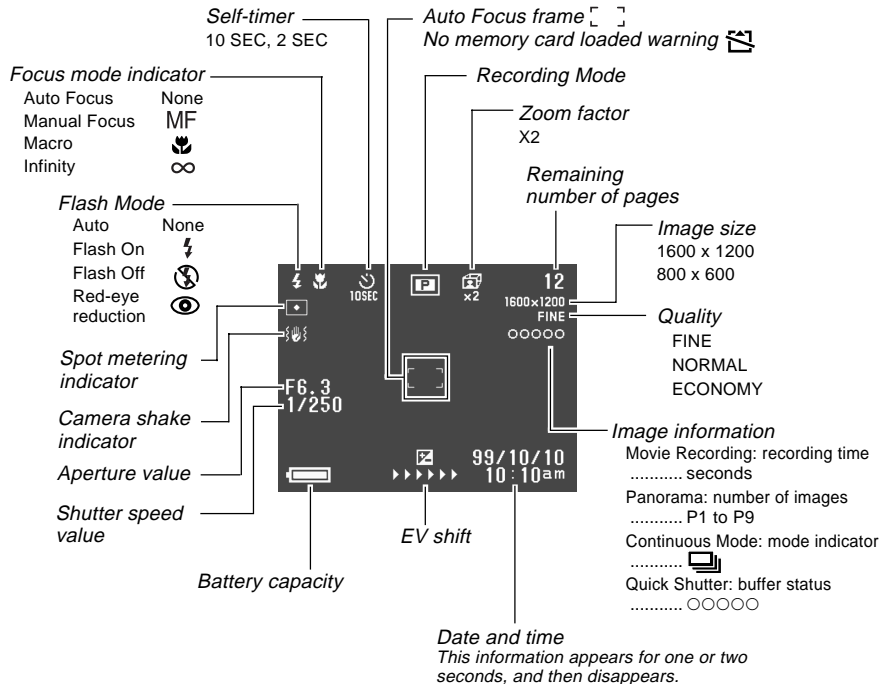

### Screen when shutter is pressed half way

Flash Mode (   )

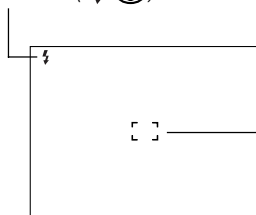

Auto Focus Frame

- Focusing complete:  
Green
- Focusing failed:  
Red

Flash indicator appears to indicate that flash will be fired (when auto flash is selected).









### Recording Mode Screen

Pressing the MODE button while in the Recording Mode displays the Record Menu. Use [▶] and [◀] to bring the icon of the function you want to the bottom of the dial, and then press SET.



Remaining number of pages

### Recording Mode Indicators

	P mode (Normal)		S mode (Shutter-priority Auto Mode)
	Movie		Landscape
	Panorama		Portrait
	A mode (Aperture-priority Auto Mode)		Night Scene

## Indicator display

The indicator display located on the top of the camera also shows various camera status indicators during image recording. The indicator display especially comes in handy when the monitor screen is turned off.

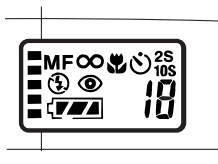

	Continuous recording shots		Battery capacity
			Macro mode indicator
MF	Manual mode indicator		Self-timer
$\infty$	Infinity indicator	2S 10S	Self-timer time settings
	Flash off indicator	number	Remaining number of images/Image number
	Red eye reduction indicator		

## Playback Mode

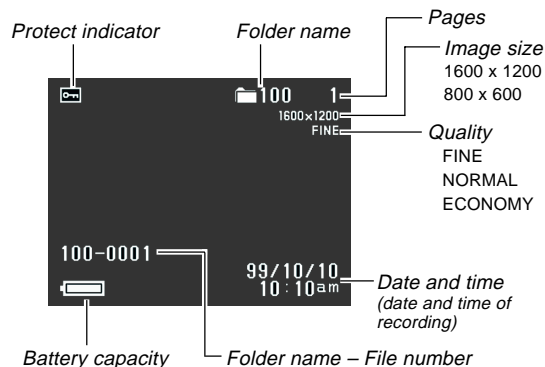

## Changing the Display Language

Use the following procedure to switch the display language between English and Japanese.

1. Press MENU.
2. Select “Set Up” → “Language”.
3. Select the display language you want.

## Menu Screens

Pressing MENU displays the menu screen. The contents of the menu screen depend on whether you are in the PLAY Mode or REC Mode. While the menu screen is on the display, press DISP to toggle between the basic menu and the advanced menu.

In this User's Guide, the basic menu is always used for items that appear on both the basic menu and advanced menu. The basic menu displays settings required for basic functions, while the advanced menu includes settings for all functions.

- See “Using the Record Menus” on page E-71 and “Using the Playback Menus” on page E-82 for more information about menu contents.

### Sample Display: REC Mode

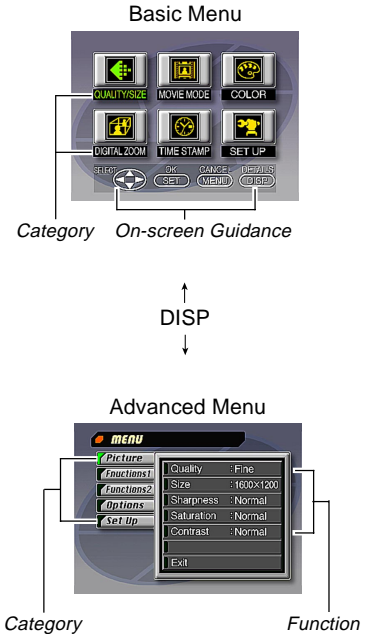

## Making menu settings

1. Slide open the lens cover.
2. Press MENU.
3. Press DISP to toggle between the basic menu and the advanced menu.
4. Use [▶],[◀],[▼] and [▲] to select the category or function you want, and then press SET.

[▶] [◀] [▼] [▲]: Item selection

SET : Execution of a selection

MENU : Returns to the previous screen or cancels settings.

- Make settings in accordance with the guidance messages that appear on the monitor screen.

5. After making the settings you want, select “Exit” and then press SET.

# MEMORY CARDS

This camera uses a memory card (CompactFlash cards) for image memory.

A memory card is loaded in the camera when you purchase it.

## IMPORTANT!

- Make sure that the power of the camera is turned off before you insert or remove a memory card.
- When inserting a memory card into the camera, make sure that the card is oriented correctly. Make sure that the correct side of the card is facing up, and that you insert the correct end of the card into the camera.

## Inserting a Memory Card into the Camera

1. Slide the memory card cover lever in the direction indicated by the arrow to open the cover.

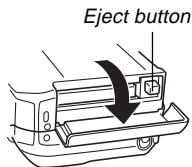
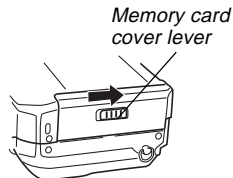

2. As shown in the illustration, slide the memory card into the slot and push it in as far as it will go.

- If the Eject button is extended, press it in before sliding the memory card into the slot.

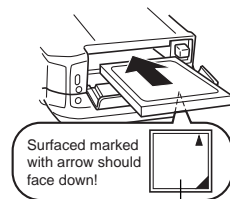

Surface marked with arrow

3. Close the memory card slot cover.



## Removing a Memory Card from the Camera

1. Slide the memory card cover lever in the direction indicated by the arrow to open the cover.

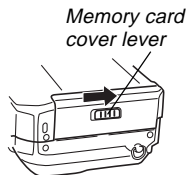

2. Press the eject button so it extends from the camera.

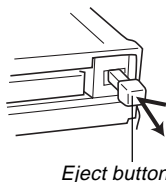

3. Press the eject button once again to eject the card.



4. Remove the memory card.

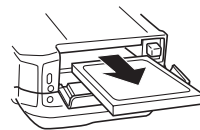

5. Close the memory card slot cover.



### IMPORTANT!

- Insert only memory cards into the memory card slot. Inserting any other type of card can cause malfunction.
- Should water or any other foreign matter get into the memory card slot, immediately turn off power, unplug the AC adaptor, and contact your original retailer or nearest CASIO Service Provider.
- Never eject the CompactFlash card while the card slot is facing downwards. Doing so creates the danger of the CompactFlash card falling, which can corrupt image data on the card.
- Never remove the memory card from the camera while the operation lamp or card access lamp is flashing. Doing so can cause loss of recorded images or corruption of memory card data.



## Formatting a Memory Card

You can format a memory card to delete all of the data stored on it.

### IMPORTANT!

- Formatting a memory card deletes all images on the card, even if some or all of the images are protected (page E-86).
- Data deleted by a memory card format operation cannot be recovered! Be sure to carefully check and confirm that you no longer need the data stored in a memory card before formatting it.

1. Press **MENU**.
2. Select **“Set Up”** → **“Format”**.
3. In response to the confirmation message that appears, select **“Yes”** to start formatting the card.

## Memory Card Precautions

- Images cannot be recorded with this camera unless a memory card is installed in it.
- Be sure to use only CASIO brand CompactFlash cards. Proper operation with other memory cards is not guaranteed.
- Static electricity, electrical noise, and other electrical phenomena can cause corruption or even total loss of the data stored on a memory card. Because of this, you should always make backup copies of important images on other media (magnetic optical disk, floppy diskette, computer hard disk, etc.).
- Memory card problems can be corrected by reformatting the memory card (page E-115). Reformatting a memory card deletes all images stored on the card, but you can use a computer to copy the images you want to keep to the computer's hard disk before reformatting your card. If you plan to be recording images where you do not have access to a computer, it is a good idea to take along an extra memory card or two just in case you experience an unexpected memory card problem.

- Formatting is recommended for any memory card that you suspect contains corrupted image data (due to a DECODE ERROR, strange image colors, malformed images) or newly purchased memory cards.
- Before starting a format operation, load a full set of new batteries (alkaline or lithium) into the camera or connect the AC adaptor to power the camera. Interruption of camera power during the format operation results in improper formatting, making it impossible to use the memory card.

## Memory Card Folder Precautions

- The camera automatically creates folders (directories) on the memory card and assigns them names based on dates (month and day). Any image you record is automatically stored into the folder that corresponds to the date it is recorded.
- Up to 900 folders can be created on a single card. The following shows a typical folder name.

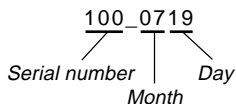

- Up to 250 image files can be stored in each folder. The following shows a typical file name.

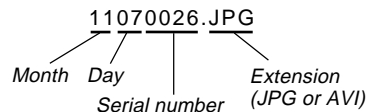

- When you try to save the 251st image to a folder, the camera automatically creates a new folder and store the image there.
- The above maximum number of files and folders are absolute maximums. The actual number of folders and files may be less due to memory card capacity and the size of each image.
- Panorama images are divided into multiple images and stored on the memory card.
- See "USING CompactFlash CARDS WITH YOUR COMPUTER" on page E-102 for information about how files and folders are organized.

# POWER SUPPLY

The camera features a two-way power supply that lets you use either batteries (AA-size alkaline, lithium or Ni-MH) or household AC current.

## Loading Batteries

Be sure that camera power is turned off whenever loading or replacing batteries.

1. On the bottom of the camera, slide the battery compartment cover lock towards the front of the camera (①) to release the cover.
2. Grasping both sides of the battery compartment cover, swing it open (②).
3. Load batteries so their plus (+) and minus (-) ends are facing as shown in the illustration.

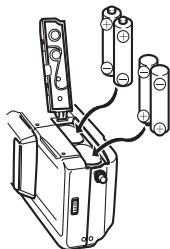
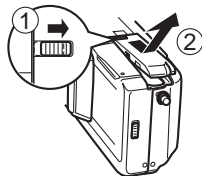

4. Close the battery compartment cover (①), and then slide the battery compartment cover lock towards the back of the camera to lock the cover in place (②).

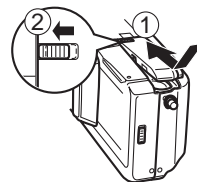

Be sure to use **alkaline**, **lithium** or **Ni-MH** batteries. Never use manganese batteries (see precautions on the next page).

- Make sure the battery compartment cover is locked securely. Failure to do so can result in the cover opening, creating the danger of personal injury and corruption of image data.

## Standard Battery Life

This camera can be powered using AA-size alkaline, lithium or Ni-MH batteries.

The battery life reference values given below indicate the amount of time at standard temperature (25°C) until power automatically turns off due to battery failure. They do not guarantee that batteries will perform the amount of service indicated. Battery life is reduced by low temperatures and continued use.

Type of Operation	AA-size Alkaline Batteries LR6	AA-size Lithium Batteries FR6	AA-size Ni-MH
Continuous Playback	170 minutes	290 minutes	180 minutes
Continuous Recording	380 shots	920 shots	550 shots

- The above figures are approximations only.
  - The above guidelines are based on the following battery types:
    - Alkaline: MX1500 (AA) DURACELL ULTRA
    - Lithium: Energizer
    - Ni-MH (Nickel-metal hydride): CASIO NP-H3
  - Battery life varies with brand.
  - Figures are based on continuous recording under the following conditions.
    - Flash turned off
    - One ZOOM slider switching between T (Telephoto) and W (Wide-angle)
- Battery life is greatly affected by how much you use flash, zoom and other functions, and how long you leave power turned on.

### ● About rechargeable batteries

- Use only the nickel-metal hydride batteries (NP-H3) that are available from your dealer as options for this camera. Proper camera operation is not guaranteed when other rechargeable batteries are used.
  - Nickel-metal hydride Batteries (4-battery set)/Quick Charger Set BC-1HB4
  - Nickel-metal hydride Batteries (4-battery set) NP-H3P4
- Be sure to keep all four batteries together as a set at all times, for both charging and powering the camera. Mixing batteries from different sets can shorten overall battery life and cause malfunction of the camera.
- Rechargeable batteries cannot be charged while they are loaded in the camera.

### ● Tips for Prolonging Battery Life

- Use the  $\frac{1}{2}$  button to turn off the flash when you are not using it.
- You can also use the power save settings (E-39) to protect against wasting battery power when you forget to turn off the camera.

### ● How low temperature affects battery life

- The life of alkaline batteries is shortened by use under very cold temperatures. The life of alkaline batteries used at 0°C is about one fifth of what it is at normal temperatures (about 25°C). When shooting under very cold temperatures, we recommend use of lithium or nickel metal hydride batteries, which are not so dramatically affected by cold. If you must use alkaline batteries, be sure to have plenty of spares on hand.

## Battery Handling Precautions







Incorrect use or handling of batteries can cause them to leak or burst and seriously damage your camera. Be sure to note the following important precautions to avoid problems with batteries.



- Use only LR6 (AM-3) type alkaline or FR6 type lithium or Ni-MH (nickel-metal hydride) dry cell batteries with this camera. Never mix old batteries with new ones. Doing so can result in bursting or leaking of batteries, creating the danger of fire or personal injury.
  - Always make sure that the positive (+) and negative (-) ends of the batteries are facing correctly, as noted by the markings on the camera itself. Improper loading of batteries can result in bursting or leaking of batteries, creating the danger of personal injury or soiling of objects nearby.
- 
- Remove batteries from the camera if you do not plan to use it for more than two weeks.
  - Never recharge batteries, never allow direct connection between two ends of a battery, and never try to take batteries apart.
  - Do not expose batteries to direct heat or dispose of them by burning. Doing so can create the danger of explosion.
  - Never mix batteries of different types.

- Dead batteries are susceptible to leakage, which can cause serious damage to your camera. Remove batteries from the camera as soon as you notice they are dead.
- The batteries that power the camera normally become warm as they discharge.

## Low Battery Indicator

The battery capacity indicator (shown only when the image information display is turned on) changes in the following sequence as battery power decreases: “” → “” → “” → “”. If you continue to use the camera while the battery level is “” or “”, camera power will automatically turn off.

## Auto Power Off (Battery Powered Operation Only)

Power automatically turns off whenever you do not perform any camera operation for a specific period. See page E-39 for details about how you can specify the Auto Power Off time.

- To restore power, simply press PLAY ON/OFF to turn power back on again.

### IMPORTANT!

The Auto Power Off function does not operate under the following conditions.

- During Slide Show (page E-80)
- While the camera is being operated from a computer or printer connected via a cable or the USB port or infrared connection (pages E-94, E-99).
- Whenever the AC adaptor is connected to the camera.

## Using AC Power

Use the optional AC adaptor (AD-C620) to power the camera from standard AC power.

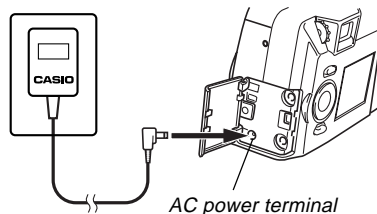

### AC Adaptor precautions

- Never use an electrical outlet whose voltage is outside the rating marked on the AC adaptor. Doing so can create the danger of fire or electrical shock. Use only the optional AC adaptor specified for this camera.
- Should the cord of the AC adaptor become damaged (exposed internal wiring), request a replacement from an authorized CASIO service provider. A damaged AC adaptor cord creates the danger of fire or electrical shock.





CAUTION

- Always be sure to use the AD-C620 AC adaptor only. Using any other AC adaptor can cause damage to the camera not covered by the warranty.
  - When unplugging the AC adaptor from the wall socket, be sure to grasp the adaptor (not the cord).
  - Avoid any undue bending, pulling, and twisting of the AC adaptor's cord, and never try to lengthen the cord by splicing it with other wire.
- Be sure to turn power off before connecting or disconnecting the adaptor.
  - Always turn camera power off before disconnecting the AC adaptor, even if the camera has batteries installed. If you don't, the camera will turn off automatically when you disconnect the AC adaptor. You also run the risk of damaging the camera whenever you disconnect the AC adaptor without first turning power off.
  - The AC adaptor may become warm to the touch after extended periods of use. This is normal and is not cause for alarm.
  - After using the camera, turn it off and unplug the adaptor from the AC outlet.
  - The camera automatically switches over to AC adaptor powered operation whenever the AC adaptor is plugged into the camera.
  - Always use the AC adaptor to power the camera whenever it is connected to a computer.

## Power Save Settings

The settings described below let you specify sleep and auto power off trigger times that help to conserve valuable battery power.

**SLEEP** ..... The monitor screen enters a sleep state if no operation is performed for a specified amount of time in the Record Mode. Pressing any button restores full power. You can specify 30 seconds, 1 minute, or 2 minutes before the sleep state is triggered, or you can turn off this setting entirely.

**AUTO POWER OFF** ..... Auto Power Off turns off camera power if no operation is performed for a specified amount of time. You can specify 2 minutes, or 5 minutes before AUTO POWER OFF is triggered.

- AUTO POWER OFF takes priority when both SLEEP and AUTO POWER OFF are both set for a 2-minute trigger time. This means camera power turns off if no operation is performed after two minutes.

## Setting SLEEP and AUTO POWER OFF Trigger Times

1. Slide open the lens cover.
2. Press MENU.
3. Select “Options” → “Power Save” → “Power Save”.
  - “Options” appears on the advanced menu only.

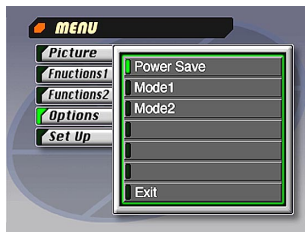

4. Use [▼] and [▲] to select “Sleep” or “Auto Power Off”.
5. Select the trigger time you want to set.
6. When the settings are the way you want them, press SET.
7. Select “Exit”.

## Initializing Power Save Trigger Times

Use the following procedure to return SLEEP and AUTO POWER OFF trigger time settings to their initial factory defaults (SLEEP: 1 minute, AUTO POWER OFF: 2 minutes).

### IMPORTANT!

Note that performing the following procedure to initialize the power save trigger time settings also initializes mode memory (page E-71).

1. Slide open the lens cover.
2. Press MENU.
3. Select “Options” → “Power Save” → “Power Save”.
  - “Options” appears on the advanced menu only.
4. Use [▼] or [▲] to select “Sleep” or “Auto Power Off”.
5. Select “Restore”.
6. Select “Exit”.



# SETTING THE CURRENT DATE AND TIME

Use the following procedures to set the current date and time, and to select the date format.

When you record an image, the time and date the image was shot is registered in accordance with data from the camera's built-in clock. You can even use the TIME STAMP function to "stamp" the date and time inside the image.

## IMPORTANT!

- The time and date settings are cleared if the camera is left for about 24 hours without battery and AC power being supplied. If this happens, restore power and make new time and date settings before using the camera again.
- A flashing time display indicates that the time and date (clock) settings have been cleared. Use the procedure on this page to make the correct time and date settings.
- If you do not set the camera's built-in clock to the current date and time, all images are recorded with the default date and time, which probably is not your correct current date and time. Be sure to correctly set the clock before you use the camera.

## Setting the Date and Time

1. Press **MENU**.
2. Select **"Set Up"** → **"Date"** → **"Adjust"**.

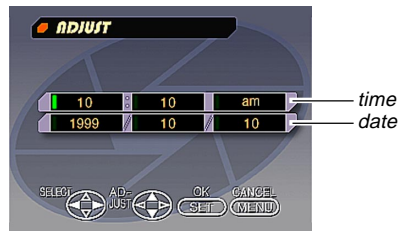

3. **Set the current date and time.**
  - Press [▼] and [▲] to change the value or setting at the green highlighted location.
  - Use [▶] and [◀] to move the green highlighting to the setting you want to change.
4. **After making all the settings on the monitor screen, press SET to register them.**

## Selecting the Date Format

Example: Sep 12, 1999

You can select any one of the following formats for the above date: 99/9/12, 12/9/99, 9/12/99.

1. Press **MENU**.
2. Select “Set Up” → “Date” → “Style”.



3. Use [▼] and [▲] to select the date format you want, and then press **SET**.

# RECORDING

## Turning On Camera Power

### 1. Slide open the lens cover to turn on power and enter the Record Mode.

- Sliding open the lens cover part way initially causes the flash to pop up.  
Sliding it the rest of the way open turns on camera power and allows the lens to extend from the camera body. Be sure to slide the lens cover open as far as it will go.
- To change to the Playback Mode, press PLAY ON/OFF.

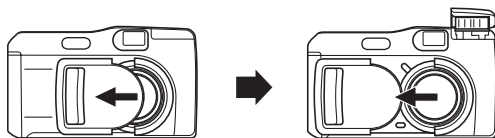

## Turning Off Camera Power

### 1. Taking care you do not press it against the lens, gently slide the lens cover in the direction that shuts it.

- This starts a shutdown operation during which the following procedures are performed.
  - a. The monitor screen turns off and the operation lamp starts to flash.
  - b. The lens retracts into the camera body.
  - c. After the lens completely retracts, the lens cover slides the rest of the way closed.
  - d. After the lens cover closes, the flash unit retracts into camera body.
  - e. The operation lamp stops flashing when the shutdown operation is complete.

### IMPORTANT!

Never open the battery compartment cover, unplug the AC adaptor, or open the memory card slot cover while the operation lamp is flashing.

## Turning Off Camera Power while the Lens cover is already closed

### 1. Press PLAY ON/OFF

- This causes the monitor screen turns off and the operation lamp to flash. The operation lamp stops flashing when the shutdown operation is complete.

## Using the Shutter Button

The following steps describe how to operate the shutter button so that Auto Focus has a chance to focus the image.

### 1. Press the shutter button about half way.

- The Auto Focus feature automatically focuses the image.

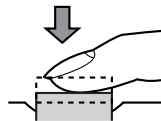

### 2. Press the shutter button as far as it will go to record the image.

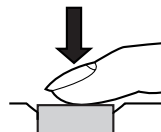

## Basic Recording Operation

The following describes the basic operation for recording images.

### 1. Slide open the lens cover.

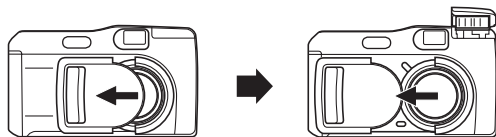

### 2. After composing the image on the monitor screen, press the shutter button about half way and hold it there.

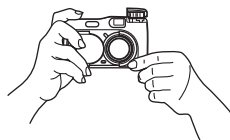

- The camera's Auto Focus feature automatically focuses the image.
- The operation lamp lights green and the Auto Focus Frame in the monitor screen turns green when the Auto Focus operation is complete.

- If you plan to use the viewfinder to compose the image, press DISP several times until the monitor screen turns off.
- Take care to avoid blocking the lens, distance sensor or light sensor with your fingers.
- Carefully press the shutter button, taking care not to move the camera as you do.

### 3. After confirming that the Auto Focus operation is complete (the operation lamp lights green), press the shutter button all the way down to record the image.

- Pressing the shutter button releases the shutter, even if Auto Focus was unsuccessful and the image is out of focus.
- After you record an image, the camera takes a few seconds to store it in memory. If you try to change to the Playback Mode while a save operation is in progress, the message "Press DISP to cancel save" appears on the monitor screen. Pressing DISP at this time cancels the save operation.
- Use of a tripod is recommended for slow shutter speeds and telephoto shots to avoid blurring of the image due to camera movement.

**IMPORTANT!**

Auto Focus tends not to work well with the following types of subjects.

- Solid color walls or objects with little contrast
- Strongly backlit objects
- Polished metal or other brightly reflective objects
- Venetian blinds or other horizontally repeating patterns
- Multiple images that are varying distances from the camera
- Subjects in poorly lit areas
- Auto Focus also may not work properly when the camera is unsteady or shaking.

These cases may make it impossible for Auto Focus to focus properly, which is indicated by the operation indicator and the Auto Focus Frame inside the monitor screen remaining red. When this happens switch to the Manual Mode for focusing (page E-57). The following are the fixed focusing distances when Auto Focus is unable to focus.

Well-lit Location: 1.5 meters minimum  
With Flash: Approximately 2 meters

**CAUTION**

- Never open the battery compartment cover, disconnect the AC adaptor from the camera, or unplug the adaptor from the wall socket while the operation lamp and the card access lamp are flashing green. Doing so will not only make storage of the current image impossible, it can also corrupt other image data already stored in camera memory.
- Fluorescent lighting actually flickers at a frequency that cannot be detected by the human eye. When using the camera indoors under such lighting, you may experience some brightness or color problems with recorded images.

## Using the Viewfinder for Recording

The illustrations below show what you see when you look through the viewfinder to compose an image for recording.

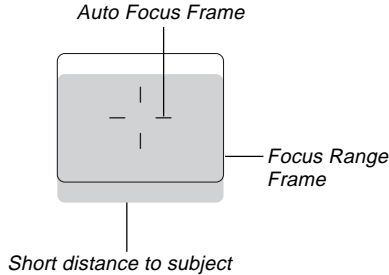

The focus range frame indicates the focus range for infinity ( $\infty$ ). As the distance between the camera and the subject decreases, however, the focus range shifts downwards. This is especially true when the ZOOM slider is in the T (telephoto) position. Because of this, you should use MF/ $\infty$ / $\infty$  to change to the Manual Mode (MF) or Macro Mode ( $\infty$ ) whenever the distance between the camera and the subject is 50cm or less.

- The monitor screen turns on automatically whenever the camera is in the Macro Mode. Use the monitor screen to compose images in the Macro Mode.

- You can use the Diopter Dial to adjust the image in viewfinder screen to your eyesight.
- Focusing of the viewfinder image is disabled while the camera is turned off or in the PLAY Mode.

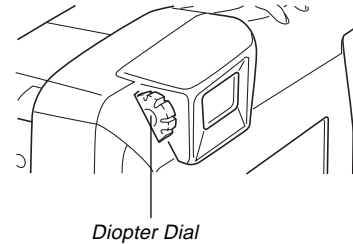

## Using Focus Lock

Normally, Auto Focus automatically focuses on the object that is inside the Auto Focus Frame. Focus lock is a technique that lets you lock the focus on a subject and then move the camera so the Auto Focus Frame is pointed at another subject when you record. This keeps the original subject in focus, even though a different object is within the Auto Focus Frame.

- The Auto Focus Frame is shown on the monitor screen only while the shutter button is being held half way down.
- Locking the focus also locks the exposure setting.

### 1. Align the Auto Focus Frame with the subject you want to lock on and press the shutter button half way down.

- The Auto Focus frame turns green when the image is in focus.



### 2. While keeping the shutter button depressed half way, move the camera and compose the image as you want.



### 3. Press the shutter button all the way down to record the image.



## Using the Flash



You can use the built-in flash unit to provide illumination during recording.

### 1. Slide open the lens cover.

### 2. Press .

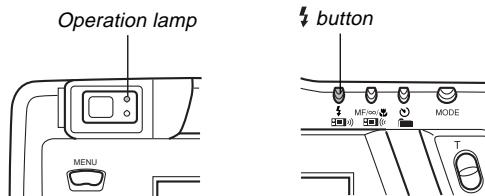
- Each press of  cycles through the flash mode in the following sequence: Auto → On → Off → Red-eye Reduction.



Indicator	Flash Mode	Description
None	Auto Flash	Flash is automatically enabled and disabled in accordance with exposure conditions.
	Flash On	Flash is always fired, regardless of exposure conditions.
	Flash Off	Flash is never fired, regardless of exposure conditions.
	Red-eye Reduction	Fires a pre-flash followed by recording with flash, which reduces the chance of red-eye.

- The monitor screen goes blank and the operation lamp flashes amber while the flash unit is charging.

## Camera Shake Indicator

The  (camera shake indicator) appears on the monitor screen when the ZOOM slider is set to T (telephoto) or when a slow shutter speed is being used.

- The  does not appear in the Night Scene Mode (page E-62).

## Flash Indicator

When you press the shutter button half way, the flash icon appears on the monitor screen and the Flash lamp light (amber) to indicate that the flash will fire when the shutter button is pressed the rest of the way down.

### IMPORTANT!

- Never use the flash in areas where combustible or explosive gas is present. Doing so creates the danger of fire and explosion.
- Never fire the flash in the direction of a person operating a motor vehicle. Doing so can interfere with the driver's vision and create the danger of accident.
- Never fire the flash while it is too close to the subject's eyes. Intense light from the flash can cause eye damage if it is fired too close to the eyes, especially with young children. When using the flash, the camera should be at least one meter from the eyes of the subject.
- Make sure that you do not touch or block the flash or light sensor with your fingers. Doing so can soil these components and interfere with correct flash operation.

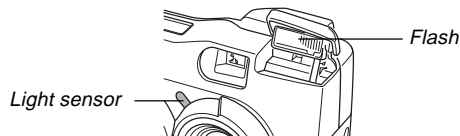

- Flash should be used for distances within the range of about 0.5 meters to 4 meters. Flash does not work well outside these ranges.
- Depending on operating conditions (type of battery being used, temperature, etc.), it may take up to 10 seconds for the flash unit to charge.
- The flash is disabled during movie and continuous recording, which is indicated by the flash icon appearing on the monitor screen.
- The flash unit will not charge when battery power is low. The  indicator flashes red to warn you that the flash will not fire correctly, which may affect exposure of the image. Replace batteries as soon as possible when this happens.
- Red-eye reduction may not work well when the camera is not pointed directly at the subject or when the subject is far from the camera.
- In the Red-eye Reduction Mode, the flash is fired automatically in accordance with exposure. Because of this, the flash will not fire in a well-lit area.
- White balance is fixed while the flash is being used, so the coloring of the recorded image may be affected by sunlight, fluorescent lighting, or other sources of illumination in the immediate area.

## Quality Settings

The camera has three quality modes: FINE, NORMAL, ECONOMY.

- To determine the number of images that can be stored on a memory card of a different capacity, multiply the capacities in the table below, by the appropriate value.
- The actual number of images that can be stored in memory cannot be specified precisely because the amount of memory required for storage of each image differs according to image contents.

Setting Indicator	FINE		NORMAL		ECONOMY	
Quality	Fine		Normal		Economy	
Image size	1600 X 1200 pixels	800 X 600 pixels	1600 X 1200 pixels	800 X 600 pixels	1600 X 1200 pixels	800 X 600 pixels
Number of Images 8MB memory card	8	22	9	29	15	39
Number of Images 64MB memory card (Option)	71	225	97	277	163	361
File Size (per image)	850 KB	200 KB	600 KB	150 KB	350 KB	120 KB

- Numbers in parentheses are compressed image file sizes.
- The figures in the left are approximations only. The actual number of images depends on image subject matter. Use the procedure under “Using the Record Menus” on page E-71 for details on changing the quality modes.
- Note that the maximum number of images that can be stored in a single folder is 250. Because of this, even if you are using a card that allows storage of more than 250 images, the camera’s monitor screen will show capacity for up to 250 images only. You will be able to store additional images by changing to another folder.
- The number of images that can be recorded may differ when you use card browser (page E-105).

## Exposure Compensation

This camera features an program AE function that automatically changes shutter speed and aperture in accordance with available light. In addition, you can also manually adjust the exposure to compensate for backlighting, indirect indoor lighting, dark backgrounds, and other special conditions.

- Press DISP to turn on the monitor screen (page E-26).

1. Slide open the lens cover.
2. Use [▶] and [◀] to perform exposure compensation.
  - Pressing [▶] or [◀] displays an EV indicator that shows the current exposure compensation setting.
  - Pressing [▶] makes the image on the monitor screen brighter. Use it to adjust for dim indoor lighting and backlighting.
  - Pressing [◀] makes the image on the monitor screen darker. Use it to adjust for bright sunlight.
  - The EV indicator turns red whenever the compensation value is at its limit.

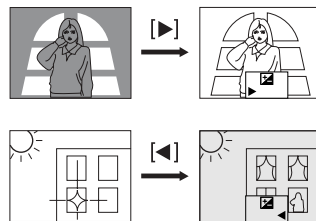

3. After adjusting the exposure, press the shutter button to record the image.

### NOTES

- Exposure compensation is generally expressed in terms of an exposure compensation (EV) value. The exposure compensation value is always set to zero whenever you turn on the camera.
- Each press of [▶] or [◀] changes the exposure compensation value by 1/3EV. A change in either direction is indicated on the monitor screen by arrows pointing left (negative correction) or right (positive correction).
- The normal maximum range for exposure compensation is  $-2\text{EV}$  to  $+2\text{EV}$ . Under certain conditions, however, the camera may impose lower maximum values when exposure compensation would result in an image that is too dark or too light.

- The exposure compensation value automatically reverts to zero whenever the shutter button is pressed. You can manually reset the exposure compensation value by using [▶] and [◀] to change the value back to zero, which is indicated when the EV indicator disappears from the monitor. EV value is fixed during panorama recording.

# OTHER RECORDING FUNCTIONS

This section describes more advanced recording operations that are also provided by this camera.

- Use the monitor screen for zoom, manual focus, macro, movie, panorama, and multiple exposure.

## Using Quick Shutter

Quick Shutter lets you record up to five images at intervals of approximately 1.5 seconds. Quick Shutter can be used to P Mode, A Mode, S Mode, Night Scene Mode, Landscape Mode, or Portrait Mode images.

### IMPORTANT!

- The card access lamp flashes while data is being written to the memory card. Never remove the memory card from the camera while this lamp is flashing.
- Quick shutter is disabled under any of the following conditions: while the flash is charging, while a slow shutter speed it being used, and when conditions cause Auto Focus to take a long time to finish.
- Even if Quick Shutter is enabled, the camera automatically uses the Single shutter mode whenever the battery level is “”.

**1. Slide open the lens cover.**

**2. Select “Functions 1” → “Shutter Mode” → “Quick”.**

- “Functions 1” appears on the advanced menu only.
- Turning on “Quick” causes “○○○○○” to appear under the quality indicator.

**3. Press the shutter button.**

- The ○ marks sequentially change to ● marks as images are recorded.
- Images you record using Quick Shutter are initially stored in a buffer, and then sequentially transferred to the memory card. Images continue to be recorded as long as you hold down the shutter button or until the buffer becomes full (five images).

## Continuous Recording

With continuous recording, you can hold down the shutter button and record up to six images at an interval of about 0.5 seconds. Continuous recording can be used for normal recording, as well as in the P, A, S, Night Scene, Landscape, and Portrait modes.

1. Slide open the lens cover.
2. Press MENU.
3. Select “Functions 1” → “Shutter Mode” → “Continuous”.
  - “Functions 1” appears on the advanced menu only.
  - The “” indicator is on the monitor screen while the Continuous Mode is selected.



## 4. Compose the image and then record it.

- Focus is locked when you record the first image, and this setting is applied to all subsequent images.
- The flash does not fire in the Continuous Mode.
- You may be able to record only five images in the Continuous Mode when using the Night Scene Mode, a fixed shutter speed, or a slow shutter speed.
- Do not start a Continuous Record operation when the low battery indicator is on the monitor screen.
- Storage of images recorded in the Continuous Mode to a memory card can take about 21 seconds (for six images).
- Never remove camera batteries, unplug the AC adaptor from the camera, or remove the memory card while images are being saved.

## Using the Zoom Features

The zoom features let you move in closer on subjects that are located far from the camera. You can choose either optical zoom or digital zoom, or even use them in combination to increase the size of the original image by 6 times its original size.

### Using Optical Zoom

Optical zoom enlarges the image by changing the focal distance of the lens.

You can increase the size of the image by three times using optical zoom.

1. Slide open the lens cover.
2. Move the ZOOM slider towards T (telephoto) to zoom in on the subject, or W (wide-angle) to zoom out.

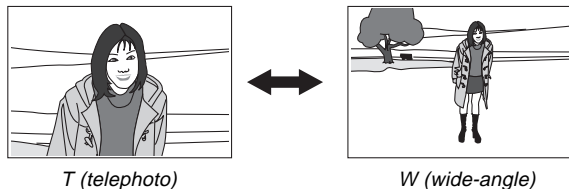
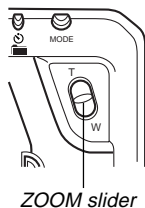

### 3. Compose the image and then record it.

- Brightness (aperture) is also affected by using optical zoom.
- Use of a tripod is recommended for slow shutter speeds and telephoto shots to avoid blurring of the image due to camera movement.

### Using Digital Zoom

Digital zoom produces a SVGA size image (800 x 600 pixels) that can be double the size of the original image.

Using digital zoom and optical zoom in combination can zoom an image to 6X.

See “Using the Record Menus” on page E-71 for details on making digital zoom settings.



## Manual Focus

Manual Focus lets you manually adjust the focus of an image.



- 1. Slide open the lens cover.**
- 2. Press MF/∞/🌻 a number of times until the MF indicator appears on the monitor screen.**
  - Each press of MF/∞/🌻 cycles the focus mode in the following sequence: Auto Focus → Manual Focus (MF) → Infinity (∞) → Macro (🌻).
- 3. While “MF” is flashing on the monitor screen, use [◀] and [▶] to focus the image.**
  - If you do not perform any focus operation for about two seconds, the “MF” indicator stops flashing.
  - After “MF” stops flashing, you can use [▶] and [◀] to adjust exposure compensation (EV).
  - If “MF” stops flashing before you have a chance to focus, press MF/∞/🌻 to make “MF” flash again.
  - Pressing MF/∞/🌻 while “MF” is flashing changes the focus mode to Infinity.

- 4. Compose the image and then record it.**

- The operation lamp and the Auto Focus frame do not appear while manual focus is in use.





## Infinity Mode Recording

Use the Infinity Mode when recording images of scenery or objects that are far away. This mode performs Auto Focus in the vicinity of  $\infty$  (infinity).

1. Slide open the lens cover.
2. Press MF/ $\infty$ / a number of times until the  $\infty$  indicator appears on the display.
  - Each press of MF/ $\infty$ / cycles the focus mode in the following sequence: Auto Focus  $\rightarrow$  Manual Focus (MF)  $\rightarrow$  Infinity ( $\infty$ )  $\rightarrow$  Macro ().
3. Compose the image and then record it.

## Using the Macro Mode

With the macro mode, you can record close up images of subjects located only 20 cm to 50 cm from the lens.

- With the macro mode, use the monitor screen to compose the image. Do not use the viewfinder.
1. Slide open the lens cover.
  2. Press MF/ $\infty$ / a number of times until the  indicator appears on the monitor screen.
    - Each press of MF/ $\infty$ / cycles the focus mode in the following sequence: Auto Focus  $\rightarrow$  Manual Focus (MF)  $\rightarrow$  Infinity ( $\infty$ )  $\rightarrow$  Macro (.
  3. Compose the image and then record it.

## Movie Recording

You can record movies that are approximately 30 seconds long. Movies are recorded in 320 x 240-pixel AVI format. For details, see “Using the Record Menu” on page E-71.

There are two types of movie recording: PAST and NORMAL. PAST lets you capture images of events that occurred before you pressed the shutter button while NORMAL records what happens after you press the shutter button.

See “Using the Record Menu” on page E-71 for details on how to select the movie length.

- AVI files can be displayed and saved on a computer that is set up to support use of CompactFlash cards. For such a computer, install QuickTime 3, which comes bundled with the camera.

### NORMAL

#### 1. Slide open the lens cover.

#### 2. Press MODE and then select .



#### 3. Compose the image and then record it.

- Auto Focus automatically adjusts in accordance with the movement of the subject.
- See “Playing Back a Movie” on page E-76 for details on playing back a movie.
- Movie recording stops automatically 30 seconds after you start the record operation.
- To stop recording before the 30-second period is up, press the shutter button.

## PAST

1. Slide open the lens cover.
2. Select “Movie Mode” → “Past”.
  - On the advanced menu, select “Functions 2” → “Movie Mode” → “Past”.
3. Press **MODE** and then select .



### 4. Compose the image on the monitor screen and then press the shutter button about half way.

- Auto Focus automatically adjusts in accordance with the movement of the subject.
- The message “STAND BY” appears on the monitor screen to indicate that the camera’s buffer memory is accumulating image data. This message remains displayed for about 10 seconds.
- After “STAND BY” disappears from the monitor screen, the contents of the buffer memory continues to be updated as long as you keep the shutter button depressed about half way.

### 5. Keep the camera pointed at the action you want to record, and press the shutter button all the way down when you want to end recording.

- Pressing the shutter button after “STAND BY” disappears from the monitor screen records everything that went on in front of the lens during the 10-second period before you pressed the shutter button.
- Pressing the shutter button while “STAND BY” is still on the monitor screen records everything that went on in front of the lens during the period from when you pressed the shutter button half way down and when you pressed it all the way down. In this case, the recording will be less than 10 seconds long.

**IMPORTANT!**

Flash is disabled during movie recording.

**NOTE**

Movie Storage Capacity

Storage Capacity	Approximately 300KB/ second
Recording Time	30 seconds per movie (NORMAL) 10 seconds per movie (PAST)

## Panorama Recording

With panorama recording you record a series of images and then link them to create a single panoramic effect.

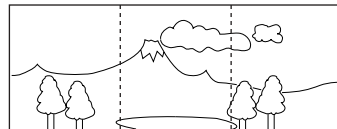

1. Slide open the lens cover.
2. Press MODE and then select .

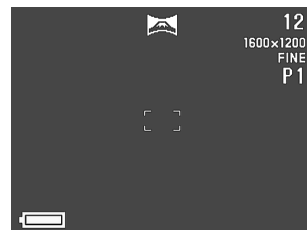

### 3. Compose the image and then record it.

- The right edge of the previous image you recorded remains on the monitor screen, so you can align it correctly with the next image.
- From the second image onwards, aim the camera further to the right and overlap the next image with the previous one on the monitor screen.
- Up to nine images can be grouped into a panorama. Press MENU when you want to stop a panorama recording operation.
- Aperture setting and white balance settings are locked when you record the first image of a panorama, and these settings are applied to all subsequent images in that panorama.
- If you want to link more than 9 images into a panorama, upload the images to a computer and use your computer application to link them.
- See “Panorama Playback” on page E-77 for details on playing back panoramas.

### Night Scene Mode

The Night Scene Mode is for recording images in dark areas. When recording images of people on a twilight or night time background, you can use the flash in combination with the Night Scene Mode for slow synchro recording.



1. Slide open the lens cover.
2. Press MODE and then select .

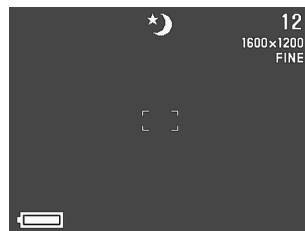

3. Compose the image and then record it.

**IMPORTANT!**

- The shutter speed is quite slow in the Night Scene Mode, so you should be sure to use a tripod to hold the camera steady.
- Slow shutter speed also causes slow monitor screen refresh. Because of this, the image recorded may be slightly different from the image that was on the monitor screen when you pressed the shutter button.
- Auto Focus is difficult in the dark. If you experience problems, use manual focusing (page E-57). There may be some blurring of the image if the subject is fast moving.
- In the Night Scene Mode, Quick Shutter records up to 4 consecutive shots.
- The contrast of Night Scene Mode images is not affected by changes made using the Record Menu's Contrast (Record Settings) settings.

**Landscape Mode Recording**

The Landscape Mode provides clear images from close ups to telephoto.

The Landscape Mode records images where everything is in clear focus, from the foreground to the background. You can use the Landscape Mode with the ZOOM slider towards W (wide-angle) to record wide-angle images with clear focus from foreground to background.

- Indoors and on cloudy days, images recorded with the Landscape Mode may not differ from those produced by normal recording.

1. Slide open the lens cover.
2. Press **MODE** and then select .



3. Compose the image and then record it.

## Monochrome and Sepia Recording

Use the following procedure to record an image in monochrome (black and white) or sepia. Note that you cannot convert an image to color after recording it in monochrome or sepia.

1. Slide open the lens cover.
2. Press MENU.
3. Use [▶], [◀], [▼] and [▲] to select “Color” and then press SET.
  - On the advanced menu, select “Functions 2” → “Color.”



4. Use [▼] and [▲] to select “B/W” or “Sepia” and then press SET.
5. Compose the image and then record it.



## Portrait Recording

In the Portrait Mode, focus is adjusted so the background is slightly blurred, which highlights the subject in the foreground.

- You can further blur the background by moving the ZOOM slider to T (telephoto) while shooting with the Portrait Mode.

- Slide open the lens cover.
- Press **MODE** and then select .



- Compose the image and then press the shutter button about half way down.
- After confirming that the subject is in focus, press the shutter button all the way down.

## Using the Self-timer



You can use the self-timer for either of the two following recording operations.

**10-second recording ....** Records about 10 seconds after the shutter button is pressed. Use this method when you want to be included in the image that is recorded.

**2-second recording .....** Records about two seconds after the shutter button is pressed. Use this method to avoid camera movement caused when the shutter button is pressed.

- Slide open the lens cover.

## 2. Press / .

- Each press of  /  cycles the self-timer in the sequence: 10SEC → 2SEC → Off.

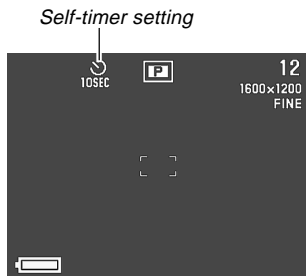

## 3. Compose the image and then record it.

- The Self-timer Lamp flashes with the passage of each second.
- In the case of 10-second recording, the monitor screen turns off as soon as the self-timer countdown starts. The monitor screen will turn back on again after the self-time operation is complete.

## Shutter Speed Priority Image Recording

You can fix the shutter speed within the range of 1/2 to 1/800 second.

- Slide open the lens cover.
- Press MODE and then select .
- Use [▼] and [▲] to select the shutter speed setting you want to use.



- Compose the image and then record it.

## Aperture Priority Image Recording

You can fix the aperture within the range of F2.0 to F11. A larger aperture (indicated by a smaller aperture value) narrows the focus range, while a smaller aperture widens the focus range.

Wide aperture



Decreased aperture



- Adjust the aperture setting to compensate for the relative brightness or darkness of the subject you are recording.

1. Slide open the lens cover.
2. Press **MODE** and then select **[A]**.

3. Use **[▼]** and **[▲]** to select the aperture setting you want to use.



4. Compose the image and then record it.

## Performing Manual White Balance

Certain lighting conditions can cause auto white balance to take a very long time or can result in a limitation of the adjustable range (color temperature). If you suspect your current lighting conditions are causing problems, try performing manual white balance. This sets white balance to a level that can be used under any lighting conditions.

The following procedure describes how to perform manual white balance using a white piece of paper. For optimum results, you should use a special reflective plate that should be commercially available from a local camera equipment shop.

1. Slide open the lens cover.
2. Press MENU.
3. Select “Functions 1” → “White Balance” → “Manual”.
  - “Functions 1” appears on the advanced menu only.

4. Keeping the camera pointed at the white sheet of paper, press DISP to make the manual white balance settings.

- Pressing SET at this time returns the camera to the white balance setting that was obtained the last time you performed this manual white balance procedure.

5. The manual white balance procedure stops automatically when it is done.

- If the manual white balance procedure does not end automatically, press SET to interrupt it.

6. After the camera finishes making the white balance setting, it returns to the screen in step 3 above. Select “Exit” to exit the manual white balance procedure.









### NOTE

White balance is automatically set to “Day Light” whenever you enter the Night Scene Mode. You can leave this as it is or change it using the above procedure.

## Recording Mode Power On Settings

A power on setting is one that is set by the camera automatically whenever you turn it on. Normally, the camera uses its own built-in power on default settings.

The following table shows the items whose settings you can save in mode memory. Note that the procedure described here only lets you select ON (save current setting in mode memory) or OFF (use the camera's preset default setting).

Mode Memory Item	On	Off
<b>Mode 1 (Mode Memory 1)</b>		
Recording Mode	P,  ,  , A, S,  ,  , 	P Mode
Focus	AF, MF, $\infty$ , 	AF
Flash	Auto,  ,  , 	Auto
Digital Zoom	Off, On	On
<b>Mode 2 (Mode Memory 2)</b>		
Metering	Multi, Center, Spot	Multi
White Balance	Auto, Day Light, Shade, Tungsten, Fluorescent, Manual	Auto
Flash Intensity	Strong, Normal, Weak	Normal

## Turning power on default settings on and off

1. Slide open the lens cover.
2. Press MENU.
3. Select “Options”.
4. Select “Mode 1” or “Mode 2”.
5. Select “Mode 1” or “Mode 2”.

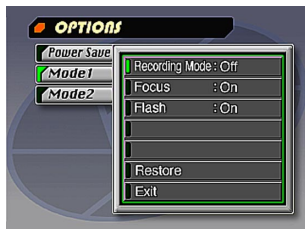

6. Select the item whose setting you want to change.
7. Select “On” or “Off”.
  - Repeat steps 6 and 7 for other items if you want.
8. Select “Exit”.

## Initializing Mode Memory

Use the following procedure to initialize the mode memory.

**IMPORTANT!**

Note that performing the following procedure to initialize mode memory also initializes power save trigger time settings (page E-40).

1. Perform steps 1 through 3 under “Turning power on default settings on and off”.
  - “Options” appears on the advanced menu only.
2. Select “Power Save”, “Mode 1” or “Mode 2”.
3. Select “Power Save”, “Mode 1” or “Mode 2”.
4. Select “Restore”.
  - The following table shows the mode memory status of each item following the above procedure.
5. Select “Exit”.

Item	Initialized Setting
<b>Power Save</b>	
Sleep	1 min
Auto Power Off	2 min
<b>Mode 1 (Mode Memory 1)</b>	
Recording Mode	Off (P Mode)
Focus	Off (AF)
Flash	On (Last mode select)
Digital Zoom	On (Last mode select)
<b>Mode 2 (Mode Memory 2)</b>	
Metering	On (Last mode select)
White Balance	Off (Auto)
Flash Intensity	Off (Normal)

- An item that is “On” stores its current setting in mode memory when camera power is turned off, and restores the setting when power is turned back on again.
- An item that is “Off” uses the camera’s preset power on default setting.

## Using the Record Menus

The record menus make it easy to control image quality, white balance, and other settings to suit specific conditions and preferences. Each record menu has two formats: a basic menu and an advanced menu. Press DISP to toggle between the basic menu and advanced menu.

### NOTE

Recording Mode, Focus, Flash, Digital Zoom, Metering, White Balance, and Flash Intensity settings are retained when camera power is turned off by only if you specify them as such with the Mode 1 and Mode 2 items of the Record Menus. All other settings are retained when you turn off camera power.

## Record Menu

See “Menu Screens” on page E-29 for information about how to use menus.

Basic menu items are indicated by **BASIC**.

## Picture

**Quality**  
**BASIC**

Use this setting to control the quality of the image.  
Fine / Normal / Economy

**Size**  
**BASIC**

You can specify either of two image sizes in pixels.  
1600 x 1200 / 800 x 600

**Sharpness**

This setting specifies the sharpness of image outlines.  
Hard : Sharp outlines  
Normal  
Soft : Soft outlines

**Saturation**

This setting controls the intensity of colors.  
High : Colors appear deeper.  
Normal  
Low : Colors appear lighter.

**Contrast**

This setting controls the difference between the light areas and dark areas of the image. Contrast is not applied in the Night Scene Mode.  
High : Larger difference between light and dark.  
Normal  
Low : Less difference between light and dark.

## Functions 1

**Shutter Mode**

This setting specifies how the shutter operates.

- Single : Records single images at an interval of about three seconds.
- Quick : Allows recording of five images at an interval of about 1.5 seconds.
- Continuous : Allows recording of sequential images at an interval of about 0.5 second while the shutter button is held down.

- With any of the above settings, the interval may be longer at slow shutter speeds.

**Metering**

This setting sets the metering method.

- Multi : Takes readings across the entire image, and provides balanced exposure settings.
- Center : Takes reading at the center of the image.
- Spot : Takes reading at a very limited spot at the center of the image. Peripheral lighting does not affect this reading, so exposure is based on the subject alone.





## OTHER RECORDING FUNCTIONS

### White Balance

Use this setting to select the white balance setting that makes the colors of the subject appear most natural.

(Auto / Day Light / Shade / Tungsten /Fluorescent/ Manual)

Day Light : Outdoors

Shade : Blue tinted sunlight

Tungsten : Red tinted incandescent light

Fluorescent : Green tinted fluorescent light

Manual : Sets up the camera for recording of a white sheet of paper under currently available light (page E-68).

### Flash Intensity

Select the setting for the flash intensity you want to use.

Strong / Normal / Weak

### Sensitivity

Select the sensitivity level.  
High/Normal

## Functions 2

### Movie Mode

**BASIC**

Select the movie mode you want to use.  
Normal / Past

### Digital Zoom

**BASIC**

This item fixes digital zoom at the setting you want.  
Off / On

### Color

**BASIC**

Use this setting to select the color mode you want.  
Color / B/W / Sepia

### Grid

This item turns an on-screen grid on or off. The grid can be used to help align image components vertically and horizontally.  
Off / On

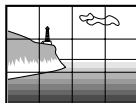

### Time Stamp

**BASIC**

Use this item to turn time stamping on and off, and to control the format of the stamp.

Off / YMD (Year-Month-Day) / D H:M (Day-Hour-Minutes) / YMD H:M (Year-Month-Day-Hour-Minutes)  
Note that the time stamp cannot be deleted from an image.

## Options

### Power Save

This item can be used to make power save settings to preserve battery power.  
Sleep (Off / 30sec / 1min / 2min) / Auto Power Off (2min / 5min)

### Mode 1

Use this item to specify which of the following settings are retained when camera power is turned off.  
Recording Mode / Focus / Flash / Digital Zoom

### Mode 2

Use this item to specify which of the following settings are retained when camera power is turned off.  
Metering / White Balance / Flash Intensity

## Set Up

<b>Card Browser</b> <b>BASIC</b>	Use this item to select the card browser file type. Off / Type1 / Type2 / Type3 / Type4
<b>Format</b> <b>BASIC</b>	Select this item to format a memory card. No / Yes
<b>Date</b> <b>BASIC</b>	Use this item to specify the format of the date that appears in the monitor screen, and to adjust the date setting. Style (Year/Month/Day / Day/Month/Year / Month/Day/Year) / Adjust
<b>Video Out</b> <b>BASIC</b>	This item can be used to specify the format of the video output signal. NTSC: Video format in the United States and Japan PAL: Video format in Europe and other areas
<b>Language</b> <b>BASIC</b>	This setting lets you select either English or Japanese as the display language.
<b>Beep</b> <b>BASIC</b>	Use this item to turn the key input confirmation tone off and on.

# PLAYBACK

The following describes the different techniques that you can use to playback recorded images.

## Basic Playback Operation

The built-in monitor screen of the camera lets you play back recorded images without connecting an external monitor.

### 1. Press PLAY ON/OFF.

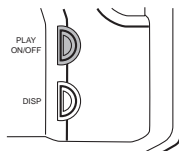

### 2. Use [▶] and [◀] to scroll through the images stored in camera memory.

- Press [▶] to scroll forward and [◀] to scroll back. Holding down either button scrolls at high speed.



## NOTES

- Pressing PLAY ON/OFF immediately after recording an image displays the image you just recorded first.
- Pressing the shutter button while a movie or panorama image is on the monitor screen starts playback of the movie or panorama .
- The image that initially appears on the monitor screen in the PLAY mode is a preview image. The full of image appears after three seconds. Images copied from another digital camera or a computer may take longer time to appear.

## Playing Back a Movie

Use the following operation to play back a movie that was recorded using the operation under "Movie Recording" on page E-59.

1. Press **PLAY ON/OFF**.
2. Use **[▶]** and **[◀]** to select the movie you want to play back.



3. Press **SET** to start playing back the movie.
  - You can use **[▶]** (forward) and **[◀]** (reverse) while playing back a movie to change the playback direction.

- To enlarge the movie image so it fills the entire monitor screen, press **DISP**. Pressing the **DISP** again returns the image to its original small size.
  - Pressing **SET** during movie play pauses playback. Press **SET** again to resume playback.
  - While movie playback is paused, you can use **[▶]** (forward) and **[◀]** (reverse) to move frame-by-frame through the movie.
4. After the movie is complete, press **MENU**.

## Panorama Playback

Use the following operation to playback panoramas recorded using the operation under "Panorama Recording" on page E-61.

1. Press **PLAY ON/OFF**.
2. Use **[▶]** and **[◀]** to select the panorama you want to play back.

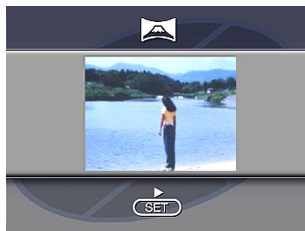

3. Press **SET** to start panorama playback.
  - You can change the direction of a panorama that is playing back by pressing **[▶]** or **[◀]**.

- Pressing **DISP** changes to a small-image display. Press **DISP** again to return to the full-screen size.
  - Pressing **SET** during panorama play pauses playback. Press **SET** again to resume playback.
  - While panorama playback is paused, you can use **[▶]** (forward) and **[◀]** (reverse) to move frame-by-frame through the panorama.
4. Press **MENU** to stop panorama playback.

## Using Zoom

The following operation lets you magnify an image to twice and a half its normal size. Note that you can zoom only a single still image.

### IMPORTANT!

Movie and panorama images cannot be zoomed.

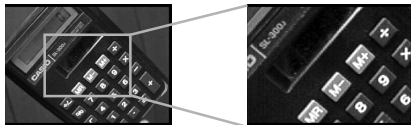

1. Press **PLAY ON/OFF**.
2. Use **[▶]** and **[◀]** to select the image you want to zoom.
3. Press **MENU**.
4. Select **“Zoom”**.
  - On the advanced menu, select **“View”** → **“Zoom”**.

### 5. Specify the area.

- The portion of the selected area appears on the display at twice and a half its normal size.
- Use **[◀]** and **[▶]** to move the area selection frame left and right. Use **[▲]** and **[▼]** to move it up and down.

### 6. To return the image to its normal size, press any button besides **[▶]**, **[◀]**, **[▼]**, **[▲]** and **DISP**.

## Displaying Nine Images

The following operation lets you simultaneously view nine images on the same screen. This capability is especially useful when playing back to the screen of a connected TV, and can be used to display a catalog of products, etc.





**1. Press PLAY ON/OFF.**

**2. Press MENU.**

**3. Select “9 Multi”.**

- On the advanced menu, select “View” → “9 Multi”.
- The first image of the set is the image that was on the screen when you performed step 2 of this operation. The other images are those that sequentially follow the first one.

**4. Use [▶] and [◀] to scroll through images stored in memory.**

- To view a particular image in normal size, press DISP. This causes the  mark to appear in the upper left corner of the monitor screen. To produce an enlarged view of an image, use [▶] and [◀] to move the  mark to the image you want and then press SET.

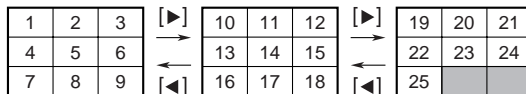

**5. After you are finished, press any button besides [▶], [◀], or DISP return to the normal single-image display.**

## Slide Show

Slide Show automatically scrolls through the images stored in memory. You can also specify how much time should be allowed between each image.



### IMPORTANT!

Auto Power Off (page E-38) is disabled whenever Slide Show is being used. This means you should not leave Slide Show running when using batteries to power the camera. Doing so can rundown batteries. Be sure to stop Slide Show and turn off the camera after you are finished.

1. Press **PLAY ON/OFF**.

2. Press **MENU**.

3. Select **“Slide Show”**.

- On the advanced menu, select “View” → “Slide Show”.

4. To stop Slide Show, press any button besides **MENU**.

- Pressing MENU while a Slide Show is in progress displays a screen that lets you change the interval within the range of 3 to 30 seconds.
- Note that all buttons are disabled while an image change is in progress. Wait until an image is stopped on the monitor screen before performing a button operation, or hold down the button until the image stops.
- Images copied from another digital camera or a computer may take longer time to appear.



## Screen Saver

The screen saver function automatically activates Slide Show (which automatically scrolls through images) whenever you do not perform any operation for about five minutes in the Playback Mode. This protects the camera's monitor screen and the screen of a connected TV against "burn in" of a static image that is left displayed too long.

### IMPORTANT!

- The screen saver is enabled only when the camera is being powered by its optional AC adaptor. If you do not perform any operation for five minutes under battery power, camera power automatically turns off (Auto Power Off).
- The screen saver displays protected images only. The screen saver is disabled if there are no protected images in memory.
- Photo Loader will not send images between the camera and a personal computer while the screen saver is turned on. Make sure you turn off the screen saver before trying to perform any image transfer operation. Note that the screen saver is turned on when you purchase the camera.

1. Press **PLAY ON/OFF**.
2. Press **MENU**.
3. Select **"Tools"** → **"Screen Saver"** → **"On"**.
  - "Tools" appears on the advanced menu only.
  - To turn off the screen saver, perform the above procedure and select "Off".
  - The screen saver activates if you do not perform any operation for about five minutes in the Playback Mode.
  - Press any key to exit the screen saver.
  - When changing between images, the screen saver uses the interval that is specified for Slide Show (page E-80).

## Using the Playback Menus

The playback menus provide you with control over the display format and DPOF settings, image delete and save operations, and other settings. Each playback menu has two formats: a basic menu and an advanced menu. Press DISP to toggle between the basic menu and advanced menu.

## Playback Menus

See “Menu Screens” on page E-29 for information about how to use menus.

Basic menu items are indicated by **BASIC**.

View	<b>Zoom</b> <b>BASIC</b>	Enlarges the image on the monitor screen.
	<b>9 Multi</b> <b>BASIC</b>	Displays nine images on the monitor screen.
	<b>Slide Show</b> <b>BASIC</b>	Automatically scrolls through the images one-by-one.

Tools	<b>Protect</b>	Use this item to protect images against deletion. Select : Protects a single specific image. Folder : Protects all images in a specific folder. All : Protects all images.
	<b>DPOF</b> <b>BASIC</b>	Use this item to specify images for printing on a DPOF printer. Select : Prints a single specific image. Folder : Prints a specific number of copies of all images in a specific folder. All : Prints a specific number of copies of all images.
	<b>Screen Saver</b>	This item turns the screen save off and on.
Set Up	<b>Card Browser</b> <b>BASIC</b>	Use this item to select the card browser file type. Off/ Type1 / Type2 / Type3 / Type4
	<b>Format</b> <b>BASIC</b>	Select this item to format a memory card.
	<b>Date</b> <b>BASIC</b>	Use this item to specify the format of the date that appears in the monitor screen, and to adjust the date setting. Style(Year/Month/Day / Day/Month/Year / Month/Day/Year) / Adjust

Set Up	<b>Video Out</b> <b>BASIC</b>	This item can be used to specify the format of the video output signal. NTSC : Video format in the United States and Japan PAL : Video format in Europe and other areas
	<b>Language</b> <b>BASIC</b>	This setting lets you select either English or Japanese as the display language.
	<b>Beep</b> <b>BASIC</b>	Use this item to turn the key input confirmation tone off and on.
Delete	<b>Select</b> <b>BASIC</b>	Deletes a single specific image.
	<b>Folder</b> <b>BASIC</b>	Deletes all unprotected images in a specific folder.
	<b>All</b> <b>BASIC</b>	Deletes all unprotected images.



# FOLDER TYPES

## Memory Card Folder Precautions

The camera automatically creates folders (directories) on the memory card and assigns them names based on dates (month and day). Any image you record is automatically stored into the folder that corresponds to the date it is recorded.

- Up to 900 folders can be created on a single card. The following shows a typical folder name.

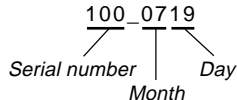

- Up to 250 image files can be stored in each folder. The following shows a typical file name.

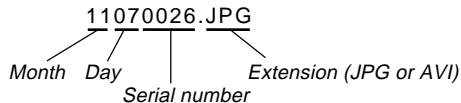

- When you try to save the 251st image to a folder, the camera automatically creates a new folder and store the image there.
- The above maximum number of files and folders are absolute maximums. The actual number of folders and files may be less due to memory card capacity and the size of each image.
- Panorama images are divided into multiple images and stored on the memory card.
- See “USING CompactFlash CARDS WITH YOUR COMPUTER” on page E-102 for information about how files and folders are organized.
- If there are more than 250 image files in a folder (due to copying from another digital camera or a computer), only the first 250 (in name sequence) can be played back.

## Selecting a Folder for Playback

1. Press **PLAY ON/OFF**.
2. Press **⏏/📁**.
3. Use **[▶]** and **[◀]** to select the folder you want to select for playback.

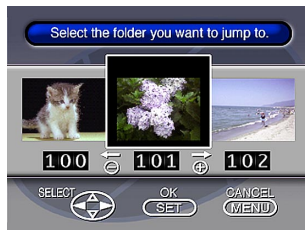

4. Press **SET** to playback the first image in the folder.

# IMAGE PROTECTION

Use the following operations when you want to protect images against accidental deletion. A protected image cannot be deleted until it is unprotected. You can protect and unprotect a single specific image, all the image in a particular folder, or all images currently on the memory card.

## IMPORTANT!

Formatting a memory card (page E-33) deletes all images on the card, even if some or all of the images are protected.

## Protecting and Unprotecting a Single Image

1. Press **PLAY ON/OFF**.
2. Press **MENU**.
3. Select **“Tools”** → **“Protect”** → **“Select”**.
  - “Tools” appears on the advanced menu only.

4. Select the image you want to protect.

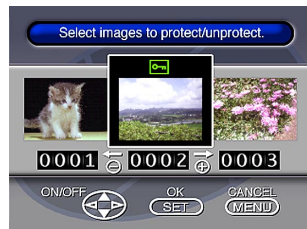

- Selected images are indicated by .
  - Repeat step 4 to select other images if you want.
5. After all the images you want to protect are selected, press **DISP** to protect them.

## Protecting and Unprotecting Folders

1. Press **PLAY ON/OFF**.
2. Press **⏻/📁**.
3. Use **[▶]** and **[◀]** to select the folder you want to protect.
4. Press **SET**.
5. Press **MENU**.
6. Select **“Tools”** → **“Protect”** → **“Folder”**.
  - “Tools” appears on the advanced menu only.
7. Select **“Protect”** or **“Unprotect”**.
  - The **🔒** indicator that is shown in the upper left corner of the images when image information is turned on indicates they are protected.
  - The **🔒** indicator does not appear when images are not protected.

## Protecting and Unprotecting All Images on a Memory Card

1. Perform steps 1 through 2 under **“Protecting and Unprotecting a Single Image”**.
2. Select **“Tools”** → **“Protect”** → **“All”**.
  - “Tools” appears on the advanced menu only.
3. Select **“Protect”** or **“Unprotect”**.
  - The **🔒** indicator that is shown in the upper left corner of the images when image information is turned on indicates they are protected.
  - The **🔒** indicator does not appear when images are not protected.

# DELETING IMAGES

Use the following operations when you want to delete images. You can delete a single specific image, all the images in a particular folder or all images currently on the memory card.



## IMPORTANT!

- Image deletion cannot be undone. Before deleting an image, make sure you no longer need it or you have a back-up copy saved on your computer, on diskette, or on some other medium.
- Be especially careful with “Deleting All Unprotected Images” operation, which deletes all unprotected images in memory.
- A protected image cannot be deleted. See “Image Protection” on page E-86 for details on protecting and unprotecting images.

## Deleting a Single Image

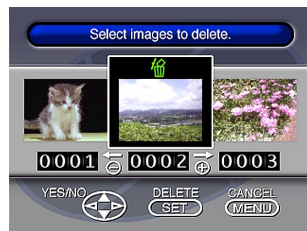
1. Press **PLAY ON/OFF**.
2. Press **MENU**.
3. Select “Delete” → “Select”.
4. Select the image you want to delete.



- Protected images are not displayed.
  - Note that the first time you display an image its  icon is turned on.
5. Press [**▼**] or [**▲**] to toggle the  mark of the selected image on and off.
    - If you want to delete more than one image, repeat steps 4 and 5.



**6. After all the images you want to delete are selected, press SET to delete them.**

- Deleting a panorama deletes all of the images that make it up as well.

**NOTE**

The camera does not maintain open spaces in its memory. Deleting an images causes all images following the deleted image to be shifted up.

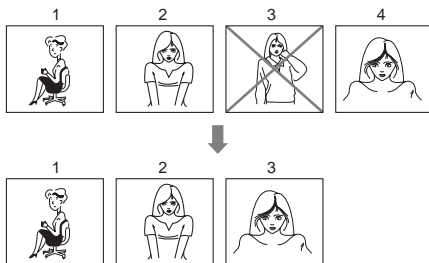

**Deleting All the Images in a Folder**

1. Press PLAY ON/OFF.
2. Press / .
3. Use [▶] and [◀] to select the folder you want to delete.
4. Press SET.
5. Press MENU.
6. Select “Delete” → “Folder”.

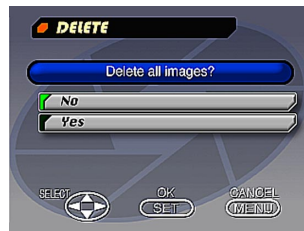

**7. Select “Yes” to delete the contents of the folder, or “No” to abort the delete operation without deleting anything.**

- When the above procedure is performed while there are protected images in memory, the first of the protected images appears on the monitor screen after the unprotected images are deleted.

### Deleting All Unprotected Images

- 1. Press PLAY ON/OFF.**
- 2. Press MENU.**
- 3. Select “Delete” → “All”.**
- 4. Select “Yes” to delete all unprotected images, or “No” to abort the delete operation without deleting anything.**

- When the above procedure is performed while there are protected images in memory, the first of the protected images appears on the monitor screen after the unprotected images are deleted.

# DPOF

The letters “DPOF” stand for “Digital Print Order Format,” which is a format for recording on a memory card or other medium which digital camera images should be printed and how many copies of the image should be printed. DPOF makes it possible for a DPOF compatible printer or professional print service to print images from a memory card without having to specify individual file names.

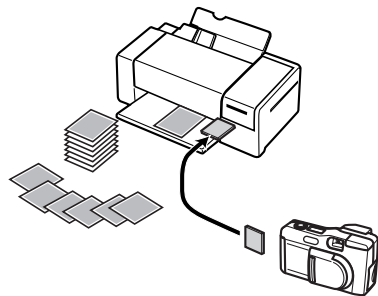

## Printing Specific Images

1. Press **PLAY ON/OFF**.
2. Press **MENU**.
3. Select “**DPOF**” → “**Select**”.
  - On the advanced menu, select “Tools” → “DPOF”.
4. Use **[▶]** and **[◀]** to select the image you want to print.
5. Press **[▼]** or **[▲]** to toggle the  mark on (print) or off (do not print).

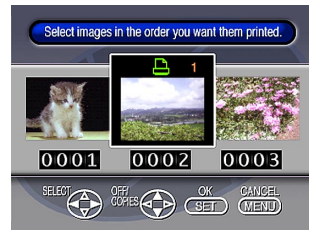



**6. Use [▼] and [▲] to specify the number of copies you want to print.**

- If you want to specify more images for printing, repeat steps 4 through 6.
- If you change your mind about printing an image, press [▼] to clear its  mark.

**7. After you are finished, press SET to exit the image specification procedure.**

### Printing All the Images in a Folder

- 1. Press PLAY ON/OFF.**
- 2. Press / .**
- 3. Use [▶] and [◀] to select the folder you want to print.**
- 4. Press SET.**
- 5. Press MENU.**
- 6. Select “DPOF” → “Folder” → “Set print order”.**
  - On the advanced menu, select “Tools” → “DPOF” → “Folder” → “Set print order”.
  - To cancel current print settings, select “Cancel print order”.
- 7. Press SET.**
  - If you selected “Cancel print order” in step 4, pressing the shutter button returns to the playback screen.

8. Use [▼] and [▲] to specify the number of copies of each image you want to print.



9. After you are finished, press SET to exit the image specification procedure.

## Printing All Images

1. Press PLAY ON/OFF.
2. Press MENU.
3. Select “DPOF” → “All” → “Set print order”.
  - On the advanced menu, select “Tools” → “DPOF” → “All” → “Set print order”.
  - To cancel current print settings, select “Cancel print order”.
4. Press SET.
  - If you selected “Cancel print order” in step 3, pressing the shutter button returns to the playback screen.
5. Use [▼] and [▲] to specify the number of copies of each image you want to print.
6. After you are finished, press SET to exit the image specification procedure.

# CONNECTIONS

This camera is equipped with a VIDEO OUT terminal for connection to a television or video deck, and a DIGITAL terminal and USB port for connection to a computer or other equipment.

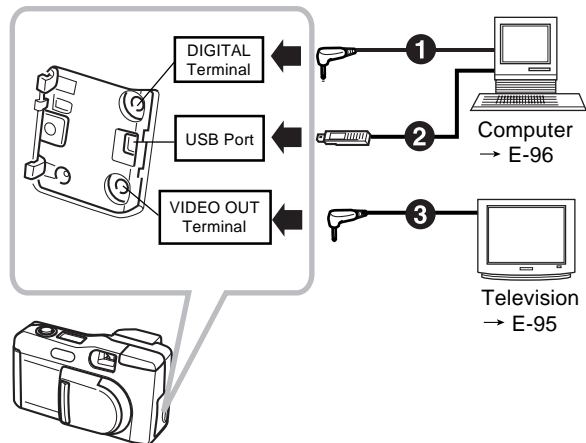

## 1 Cables

The type of cable you should use depends on the type of equipment to which you are connecting.

## 2 Special USB cable

When connecting to a computer, use the special USB cable and USB driver software that comes with the camera.

## 3 Special video cable that comes with camera

## IMPORTANT!

- Be sure to turn off both the camera and other equipment before making any connections.
- Check the documentation that comes with your other equipment for information you may need to know when making connections.
- Leaving the same image displayed on a television or computer display screen for very long periods can cause the image to be “burned in” on the screen. When this happens, a faint after-image remains on the screen, even after you disconnect the camera. To avoid this, you should not leave the same image displayed on such a screen for very long periods.
- This camera does not support cable transfer of data with other CASIO digital cameras.

# CONNECTING TO OTHER EQUIPMENT

## Connecting to a Television

Images being displayed on the camera's monitor screen, whether for recording or playback can also be displayed on the screen of a connected television.

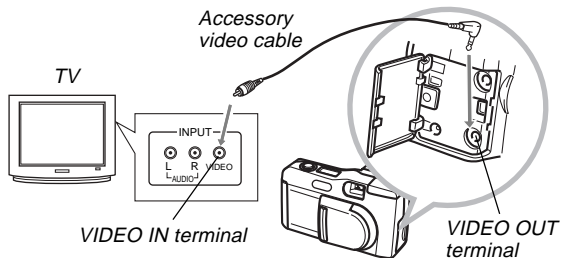

- 1. Connect one end of the video cable to the camera and the other end to the television.**
- 2. Set up the television for video input.**
  - See the documentation that comes with the television for information about how to do this.
- 3. The connection procedure is the same for both recording and playback.**

## IMPORTANT!

- A television must have a video input terminal like the one shown in the illustration to connect to this camera.
- Battery capacity (page E-28) and other displays that normally appear on the camera's monitor screen are also displayed on the television screen.
- The monitor screen goes blank as soon as you connect the video cable to the camera.

## Selecting the Video Output Signal Mode

You can select either of two common video output modes: NTSC or PAL.

The video system you should use depends on the country where you plan to use the output signal. In the United States or Japan, for example, you should use NTSC, but in Europe you need to use PAL.

Check with your local video or TV retailer if you are unsure about which video mode you should use in your country.

- 1. Press MENU.**
- 2. Select “Set Up” → “Video Out”.**
- 3. Select the video mode you want to use.**

## Connecting to a Computer

The following accessories are included with the camera to make it easy for you to connect to a computer to transfer and manage your images.

- USB cable
- USB driver software (on CD-ROM)
- Data Transfer Cable
- Photo Loader application (on CD-ROM)

## USB Port Connections

The camera's USB port and accessories make it easy to connect to a computer equipped with a USB port. First install the USB driver software that comes bundled with the camera on your computer, and then use its special USB cable to make the connection. Once connected, you can view images on your computer's display and store images on its hard disk.

- See the separate installation manual for information about how to install the driver software on your computer.

## System Requirements

Windows	Macintosh
<ul style="list-style-type: none"> <li>• IBM PC/AT or compatible computer pre-installed with Windows 98</li> <li>• 486 or higher CPU (Pentium recommended)</li> <li>• CD-ROM drive (for installation)</li> <li>• Keyboard and mouse or equivalent input device</li> <li>• Available USB port</li> </ul> <p>* Proper operation is not guaranteed under the following conditions.</p> <ul style="list-style-type: none"> <li>• A computer that has been updated from Windows 95 to Windows 98</li> </ul> <p>* This USB driver does not run under Windows 3.1, Windows 95 or Windows NT.</p>	<ul style="list-style-type: none"> <li>• Mac OS 8.5 or higher, Mac OS 8.1 with USB system extensions (iMac update 1.0 is required)</li> <li>• Power PC G3</li> <li>• CD-ROM drive (for installation)</li> <li>• Keyboard and mouse or equivalent input device</li> <li>• Available USB port</li> </ul>

\* The USB driver may not run correctly under certain hardware configurations.



## USB Port Connection

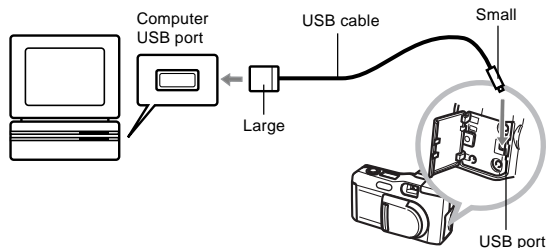

### IMPORTANT!

- Whenever connecting the USB cable to the camera, make sure the arrow mark on the plug is aligned properly with the arrow mark on the side of the camera's terminal.
- Plug the USB connectors into the ports as far as they will go. Incorrect connection can result in improper operation.
- Turn off the camera before connecting the USB cable to it.
- The camera is not supplied power by the USB cable. Be sure to use the optional AC adaptor to power the camera whenever using a USB cable connection.
- Never disconnect the USB cable while a data communication operation is in progress. Doing so can corrupt memory data.

## Data Transfer Cable Connection

You can use the Data Transfer Cable to connect to your personal computer through the camera's DIGITAL terminal. Then you save images on your computer's hard disk using the Photo Loader application.

- See the separate installation manual for information about how to install Photo Loader on your computer.

### Windows 95, 98, NT Workstation 4.0

The Data Transfer Cable can be connected to an IBM PC/AT or compatible that is equipped with a D-Sub9 RS-232C terminal.

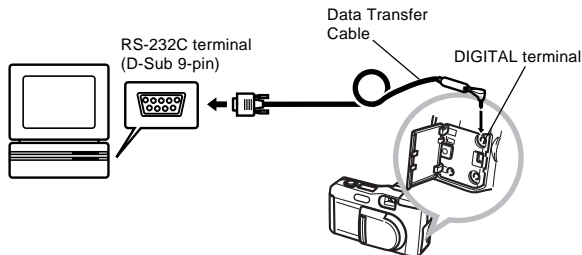

## Macintosh

Connection of the Data Transfer Cable and operation of the Photo Loader application is not supported on an Apple Macintosh.

### IMPORTANT!

- See the documentation that comes with Photo Loader for information about system requirements.
- Be sure to turn off the camera, computer, and all peripherals (monitor, disk driver, etc.) connected to the computer before connecting the digital camera with the Data Transfer Cable.
- Never connect or disconnect the cable while Photo Loader is running. Doing so can cause problems with program execution, can corrupt data, and can damage the camera and your computer.
- Data transfer while camera batteries are low can result in sudden shutdown of the camera. Because of this, use of the optional AC adaptor is recommended whenever performing data communication with the camera.
- This camera does not support data communication with any of the optionally available CASIO PC link software applications: LK-1, LK-1A, LK-10V, LK-11W, LK-2, LK-2A, LK-2V, LK-21.

This camera can perform IrDA data communication with digital equipment that supports IrTran-P protocol.

Infrared data transfer capabilities let you exchange image data with another digital camera without physical connection.

- This camera uses IrDA IrTran-P protocol, which was jointly developed by NTT, Sony, Sharp, Okaya Systemware and CASIO to provide a means for transferring digital camera still images using infrared signals. (January 1998)

## IMPORTANT!

- IrTran-P communication can be performed only with equipment that supports IrTran-P protocol.
- During IrTran-P image data transfers, the ID (product identification string) of the other equipment is shown on the camera's monitor screen. The ID normally shows the manufacturer and product name, but no ID may appear at all, depending on how the equipment was set up by the manufacturer.
- When performing IrTran-P data communication with another QV-2000UX/Ir camera, images are transferred as-is, without any change in size (1600 x 1200 or 800 x 600 pixels).
- When using IrTran-P data communication to send image data to a CASIO QV-770 digital camera, QV-2000UX/Ir 1600 x 1200 images are converted to 800 x 600 images.
- How images are affected by IrTran-P transfers with other equipment depends on the other equipment.

## Receiving Data

### 1. Press PLAY ON/OFF.

### 2. Press (◀).

- This causes the receive stand by screen to appear.



### 3. Align the infrared port of the camera with the port of the sending unit, and start the send operation.

- See the documentation that comes with the sending unit for details on its operation.

## Sending Data

Transferring a movie or panorama to another model QV Digital Camera (other than the QV-2000UX/Ir) causes the images to be ungrouped. Such images cannot be played back on other CASIO QV Digital Camera Models. You can send a single specific image.

1. Press **PLAY ON/OFF**.
2. Use **[▶]** and **[◀]** to select the image you want to send.
3. Press **☰☑☹☹**.
  - This causes the send stand by screen to appear.



4. Align the infrared port of the receiving device that supports IrTran-P protocol.

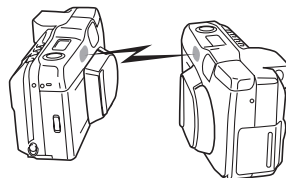

- Position the cameras so they are 10cm to 30cm apart from each other.
- To cancel an image data send operation, press **MENU**.

## Infrared Data Transfer Precautions

- Make sure that the infrared ports of the sending unit and the receiving unit are pointed straight at each other, and that there is nothing blocking the path between them.
- To avoid problems that occur due to sudden loss of battery power during infrared image transfer, we recommend that you use the separately AC adaptor specified for this camera when transferring images.
- Avoid performing infrared data transfers in areas exposed to direct sunlight or other strong illumination.
- Such conditions as natural outdoor light, low battery power, too much distance between infrared ports, and misalignment of infrared ports can cause failure of image transfers or corrupted data.
- Proper image data transfer is impossible whenever there is anything blocking either of the infrared ports.
- Do not locate any other infrared emitting device (such as remote control units) or fluorescent lighting in the vicinity of the cameras while they are performing infrared image transfers.
- Failure to be able to establish an IrDA connection can mean that the device you are trying to communicate with does not support the IrDA standard, or that the applications being used are not compatible. When this happens, you probably have to connect the camera to the computer with a separately available cable for data transfer.

# USING CompactFlash CARDS WITH YOUR COMPUTER

## Setting Up to Access CompactFlash Card Contents From Your Computer

You can use any of the three methods described below to access the contents of a memory card with your computer. You can use the Photo Loader software to save images on the memory card to your computer.

### CompactFlash Memory Card Slot

If your computer has a CompactFlash Memory Card Slot, insert the camera's memory card into the slot.

### PC Card Slot

In this case you need an optionally available CASIO CA-10 PC Card Adaptor. See the instructions that come with the PC Card Adaptor and the documentation that comes with your computer for details on using this type of configuration.

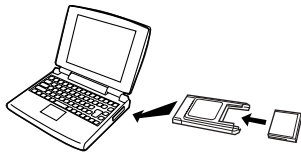

## Other Desktop Computer Configurations

Some desktop computers require a separately available PC card reader/writer and the optionally available CASIO CA-10 PC Card Adaptor to read memory card contents. See the instructions that come with the PC card reader/writer and the PC Card Adaptor for details on using this type of configuration.

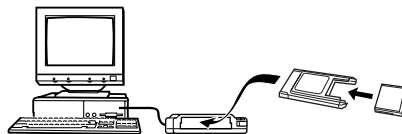

## Memory Card Data

Images recorded with this camera and other data is stored on the memory card using DCF (Design Rule for Camera File System) protocol. DCF protocol is designed to make it easier to exchange image and other data between digital cameras and other devices.

### DCF Protocol

DCF devices (digital cameras, printers, etc.) can exchange images with each other. DCF protocol defines the format for image files data and the directory structure for the memory card, so images can be viewed using another manufacturer's DCF camera or printed on a DCF printer.

In addition to support for the DCF protocol, your CASIO digital camera also shows dates in image folder names and image file names, which helps to make data management easier.

## CompactFlash Card Directory Tree

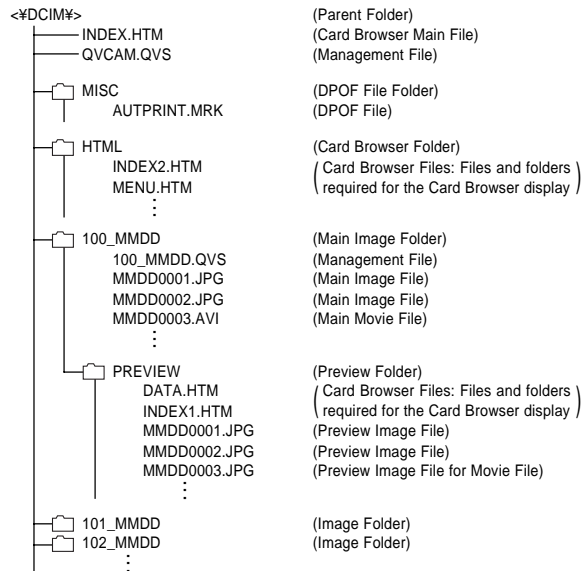

### Folder and File Contents

- Parent Folder  
Contents: All files used by the digital camera
- Card Browser Main File  
Contents: Template for card browser, which is used for viewing image previews with a web browser
- Management File  
Contents: Information about folder management, image sequence, etc.
- DPOF File Folder  
Contents: DPOF files
- DPOF File  
Contents: Printer data
- Card Browser Folder  
Contents: Files used by the card browser
- Card Browser File  
Contents: Data used by the card browser
- Main Image Folder  
Contents: Image files recorded by the camera
- Main Image File  
Contents: Still image file recorded by the camera

- Main Movie File  
Contents: Movie file recorded by the camera
- Preview Folder  
Contents: Preview images
- Preview Image File  
Contents: Preview images of still image and movie files used for temporary playback and card browser previews

### Image Files Supported by the Camera

- Image files recorded with the CASIO QV-2000UX/Ir Digital Camera
- JPEG files stored using Photo Loader (1600 x 1200 pixels or 800 x 600 pixels JPEG file)
- DCF protocol image files



## Personal Computer

- This camera uses management files to manage the sequence and attributes of image files. Because of this, adding files, deleting files, changing management file contents, or changing file sequence and attributes with your computer can cause panorama images to become ungrouped. It can also result in slower image scrolling on the camera.
- When transferring CompactFlash card contents to a hard disk, floppy diskette, MO disk, or other external storage, keep everything in the DCIM folder together. Changing the name of the DCIM folder to a date is a good way to keep track of your images. However, be sure to change the name of this folder back to DCIM if you ever copy it back to the memory card for playback on the camera. This camera does not recognize any folder name besides DCIM.
- The above is also true about the names of folders inside the DCIM folder. These folders must be returned to the names assigned to them by the camera whenever you copy the DCIM folder back to the memory card for playback on the camera.
- Never delete or modify the QVS file in any way.
- We also strongly recommend that after transferring data from a CompactFlash card to other external storage that you re-format the card and delete its contents before using it to record more images.

## Card Browser

Card Browser makes it possible to use a browser application to view images recorded with the QV-2000UX/Ir.

- The HTML file generated by this camera is best viewed using Microsoft Internet Explorer 4.01 or later, or Netscape Communicator 4.5 or later. It cannot be viewed using Photo Loader.
- QuickTime 3 is required to play back AVI movie files.

1. Press **MENU**.
2. Select **“Set Up”** → **“Card Browser”**.



### 3. Specify the format.

There are four Card Browser formats.

Type1.....This is a powerful format that provides detailed information about each image and also includes a Slide Show feature.

Type2.....This format is a viewer with a Slide Show feature.

Type3.....This format shows information about each image. You should be able to use it with any browser, regardless of version.

Type4.....This format provides basic image viewing. Since it is the simplest option, you should be able to use it with just about any browser, regardless of version.

Card Browser Format	Type1	Type2	Type3	Type4
Data Screen	○	○	×	×
Index Screen	○	×	○	×
Actual Size (in pixels)	×	○	×	○
VGA Size	○	×	○	×
SXGA Size	○	×	○	×
Image Scrolling	○	×	○	×
Slide Show	○	×	○	×
Full Screen	○	×	○	×
Movie (AVI) Play	Endless	One Time	Endless	One Time

#### IMPORTANT!

- Note that the Type1 and Type3 formats use Java Script, so their use requires Microsoft Internet Explorer 4.01 or later, or Netscape Communicator 4.5 or later.
- In the case off Type1 and Type3, Slide Show displays SVGA (800 x 600) size images in the same size as UXGA (1600 x 1200) images. Because of this, image details may appear relatively coarse.

- The index screen uses the contents of the Preview Folder (page E-104). Images copied from another digital camera or a computer may not have preview images, and so they do not appear in the index screen. If this happens, scroll through the images on the monitor screen until the copied images appear. At this time, the camera automatically generates a preview image, which will now appear on the Card Browser index screen.
- Turning on Card Browser causes an HTML file to be generated whenever you turn off camera power.
- Selecting "Off" in step 3 of the above procedure turns off Card Browser.
- Creation of an HTML file causes an INDEX.HTM file and other files to be added to the DCIM folder.

### IMPORTANT!

- Though the camera's monitor screen goes blank when you turn off power, the operation lamp continues to flash for some time as the camera internally generates a Card Browser file (when Card Browser is turned on). Performing any of the operations while the operation lamp is flashing not only stops generation of the Card Browser file, it can also result in corruption of the image data on the CompactFlash Card. Note that a Card Browser file may be corrupted if batteries are low or if the CompactFlash Card becomes full during file generation.

- If the CompactFlash card in the camera has a large number of files on it, it may take quite a bit of time for the camera to generate the required HTML files and actually turn off after you press PLAY ON/OFF. Because of this, we recommend that you normally leave Card Browser turned off, except when you actually want to generate HTML files.
- This camera generates a Card Browser file whenever you turn off power. When the card in the camera contains a large number of files, it may take some time for the file generation operation to be performed. You can turn off the Card Browser feature if you do not want a file generated each time you turn off camera power.

## How to use the HTML file

### Viewing HTML File Contents

Load the CompactFlash card into a card slot of your computer (page E-102). Now drop the INDEX.HTM file (in the DCIM folder) onto your Web browser to display a list of all images contained on the CompactFlash card. For information about importing data from a memory card, see “Setting Up to Access CompactFlash Card Contents from Your Computer” (E-102) and “Connecting to a Computer” (E-96).

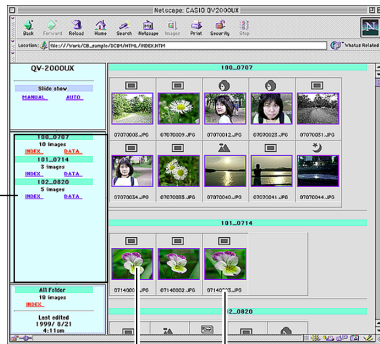

Folder name      Image      File name

Clicking on a folder name displays the following data about the images contained in the folder.

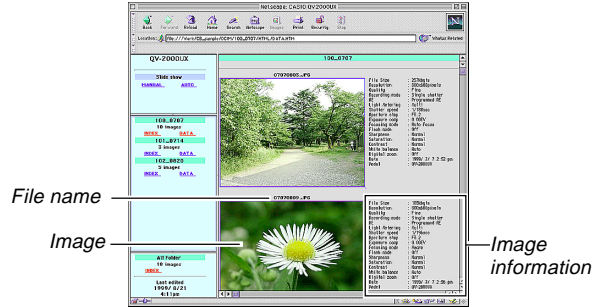

### Image Information

- File size (KB)
- Resolution (pixels)
- Quality
- Recording mode
- AE
- Light metering
- Shutter speed
- Aperture stop
- Exposure comp
- Focusing mode
- Flash mode
- Sharpness
- Saturation
- Contrast
- White balance
- Digital zoom
- Date
- Model

Click Index to return to the image list.

## Function Descriptions

<b>Index Screen</b>	When the computer accesses the memory card, it opens the INDEX.HTM file in the DCIM folder and displays an index of folders, with the newest one first. Clicking the INDEX button under a folder name in the left frame displays an index of all the images in the folder. Clicking the INDEX button under ALL Folder displays an index of all the files in all folders.
<b>Data Screen</b>	Clicking the DATA button under a folder name in the left frame displays the images in the folder and their recording information.
<b>Actual Size</b> (in pixels)	Accessing the memory card on your computer and clicking the INDEX.HTM in the DCIM folder displays 320 x 240-pixel size images in the newest folder. Clicking directly on the image changes SXGA size or VGA size, whichever was the recorded size of the image. This function is available with the Type2 and Type4 formats only.
<b>VGA Size</b>	Clicking directly on an image in the index or data screen displays its VGA size (CHILD PAGE) image.
<b>SXGA Size</b>	Clicking directly on a VGA size image displays its SXGA (IMAGE DISPLAY) image. The SXGA image is always displayed, regardless of the recorded size of the image.

<b>Image Scrolling</b>	Clicking the arrows above a VGA size image scrolls forward and back through the images. Clicking directly on an SXGA size image advances to the next image. You can select page scrolling for a particular folder or all folders. AVI files are not displayed.
<b>Slide Show</b>	Images in a specific folder or all folders opened to the maximum window size to match the monitor being used. AUTO or MANUAL can be selected as the image change type. AVI files are not displayed.
<b>Full Screen</b>	Selecting AUTO for the slide show causes images in a specific folder or all folders opened to the maximum window size to match the monitor being used. Images are changed at an interval of about five seconds.
<b>Movie (AVI) Play</b>	AVI movie files can be played back on the screen. Playback image size is the same as the record image size. Endless playback is performed with the Type1 or Type3 format, while Type2 and Type4 plays the movie once and then stops.

### **Saving an HTML File**

- You can use the Photo Loader application that comes bundled with the camera to easily save the images in the HTML file to a computer. See the documentation that comes with Photo Loader for details.
- Before using the CompactFlash card again (after storing its images on other media), delete all its current files or reformat the card.

# TROUBLESHOOTING

	Symptom	Probable Cause	Action
Power Supply	No power	<ol style="list-style-type: none"> <li>1. Batteries not loaded correctly.</li> <li>2. Dead batteries</li> <li>3. Wrong AC adaptor</li> <li>4. Lens cover is not completely open.</li> </ol>	<ol style="list-style-type: none"> <li>1. Correctly load batteries (page E-35).</li> <li>2. Replace all four batteries with a set of new ones (page E-35).</li> <li>3. Use only recommended AC adaptor .</li> <li>4. Completely open the lens cover.</li> </ol>
	Sudden power failure	<ol style="list-style-type: none"> <li>1. Auto Power Off</li> <li>2. Low battery power</li> <li>3. Use of manganese batteries.</li> </ol>	<ol style="list-style-type: none"> <li>1. Turn power back on.</li> <li>2. Replace all four batteries with a set of new ones (page E-35).</li> <li>3. Replace manganese batteries with alkaline, lithium or Ni-MH batteries.</li> </ol>
	"  indicator on LCD	Batteries are about to go dead.	Replace all four batteries with a set of new ones (page E-35).
Recording	No recording when shutter button is pressed	<ol style="list-style-type: none"> <li>1. The lens cover is closed.</li> <li>2. Flash unit is charging.</li> <li>3. The message "MEMORY FULL" is on the monitor screen.</li> <li>4. Insufficient memory card capacity or no memory card loaded in camera.</li> </ol>	<ol style="list-style-type: none"> <li>1. Slide open the lens cover.</li> <li>2. Wait until flash unit charging is finished.</li> <li>3. Delete images you no longer need from camera memory.</li> <li>4. Load a memory card.</li> </ol>
	Auto Focus cannot focus the image.	<ol style="list-style-type: none"> <li>1. Lens is dirty.</li> <li>2. The object you want to focus is not in the focus frame.</li> <li>3. Conditions make it impossible to obtain proper focus.</li> <li>4. Camera is unsteady or shaking.</li> </ol>	<ol style="list-style-type: none"> <li>1. Clean off the lens.</li> <li>2. Aim the camera so the object you want to focus is in inside the focus frame.</li> <li>3. Switch to the Manual Mode and focus manually.</li> <li>4. Use a tripod to steady the camera.</li> </ol>

## TROUBLESHOOTING

	Symptom	Probable Cause	Action
Recording	The recorded image is out of focus.	The focus setting is not correct.	Make sure the subject you want to focus is within the Auto Focus Frame when you record the image.
	Power failure during self-timer operation	Low battery power	Replace all four batteries with a set of new ones (page E-35).
	Monitor screen image is out of focus.	<ol style="list-style-type: none"> <li>1. Failure to focus the image while the camera is in the Manual Mode.</li> <li>2. Attempting to record scenery or portraits in the Macro Mode.</li> <li>3. Attempting to use the P Mode (standard recording) while the subject is within 50cm of the camera.</li> </ol>	<ol style="list-style-type: none"> <li>1. Focus the image before recording it.</li> <li>2. Use the P Mode for scenery and group shots.</li> <li>3. Use the Macro Mode for close ups.</li> </ol>
	Viewfinder image is dim.	<ol style="list-style-type: none"> <li>1. Camera is not in the REC Mode.</li> <li>2. Diopter is not adjusted correctly.</li> </ol>	<ol style="list-style-type: none"> <li>1. Slide open the lens cover to enter the REC Mode.</li> <li>2. Rotate the diopter dial until the area inside the Auto Focus frame appears clear.</li> </ol>
	Poor color and brightness when indoors	Indoor fluorescent lighting	Shoot under incandescent or other non-fluorescent lighting (page E-46).
	Cannot perform movie recording.	<ol style="list-style-type: none"> <li>1. Movie Record Mode is not selected.</li> <li>2. Insufficient camera memory capacity.</li> </ol>	<ol style="list-style-type: none"> <li>1. Select the Movie Record Mode (page E-59).</li> <li>2. Delete images you no longer need from camera memory.</li> </ol>
	Recorded image is not saved.	<ol style="list-style-type: none"> <li>1. Loss of power before image is stored in memory</li> <li>2. Memory card cover was opened before the image was fully saved.</li> </ol>	<ol style="list-style-type: none"> <li>1. Replace all four batteries with a set of new ones (page E-35).</li> <li>2. Never open the memory card cover until the image is fully saved.</li> </ol>



## TROUBLESHOOTING

	Symptom	Probable Cause	Action
Playback	Colors of recorded image are different from those on the display when image was composed.	<ol style="list-style-type: none"> <li>1. Reflection from sunlight or light from another source</li> <li>2. Image quality setting</li> </ol>	<ol style="list-style-type: none"> <li>1. Reorient the camera so that light is not shining directly into lens.</li> <li>2. Use the Recording Menu to change to a higher image quality for recording.</li> </ol>
	No [▶]/[◀] button operation during nine-page display	Button operation during page change	Wait until an image is on the monitor screen before performing a button operation.
	Cannot find an image.	<ol style="list-style-type: none"> <li>1. Memory card images recording using a camera that does not support DCF.</li> <li>2. Management files required to display images cannot be created.</li> </ol>	<ol style="list-style-type: none"> <li>1. The file management systems of cameras that do not support DCF are different from the one used by this camera. This camera cannot read cards recorded with such cameras.</li> <li>2. Make more room available on the memory card by deleting some of its images or other data.</li> </ol>
	Camera is connected to a TV, but LCD monitor contents do not appear on TV screen.	<ol style="list-style-type: none"> <li>1. Incorrect camera-TV connection</li> <li>2. Wrong TV set up</li> <li>3. Wrong video mode is selected.</li> </ol>	<ol style="list-style-type: none"> <li>1. Connect correctly using the video cable (page E-95).</li> <li>2. Set up the TV correctly.</li> <li>3. Change the video mode.</li> </ol>
	Images cannot be displayed when downloaded back the camera from a computer.	The images were on a memory card when they were opened on the computer for editing and then resaved back to the memory card.	Use the Photo Loader application to download edited images back to the camera.
Deletion	Delete operation does not operate.	All images are protected.	Unprotect the images you want to delete (page E-86).

## TROUBLESHOOTING

	Symptom	Probable Cause	Action
<b>Other</b>	Cannot select items in the Playback Menu.	Some functions are not available for playback of certain types of images.	Select a different function or change to the Record Mode.
	No buttons or switches operate.	<ul style="list-style-type: none"> <li>• Malfunction due to static electrical charge or strong impact.</li> <li>• Camera is connected to a computer.</li> </ul>	Remove batteries and disconnect the AC adaptor if you are using one. Restore power and turn the camera on. If this does not work, contact your dealer or an authorized CASIO service provider.
	Slide Show starts even though it is not selected.	Activation of the screen saver.	Turn off screen saver (page E-81).
	Nothing appears on the monitor screen.	<ol style="list-style-type: none"> <li>1. The camera is in the Sleep state.</li> <li>2. Communication over the USB cable is in progress.</li> </ol>	<ol style="list-style-type: none"> <li>1. Exit the Sleep state.</li> <li>2. After the communication operation over the USB cable is complete unplug the USB cable from the camera.</li> </ol>
	Cannot perform infrared data communication.	<ol style="list-style-type: none"> <li>1. Other device does not support IrTran-P protocol.</li> <li>2. Sending and receiving units are not positioned correctly.</li> <li>3. Object blocking the infrared light path, another device using infrared light is in the vicinity, or fluorescent lighting.</li> <li>4. Direct sunlight</li> </ol>	<ol style="list-style-type: none"> <li>1. Communicate only with devices that support IrTran-P protocol.</li> <li>2. Orient the infrared ports of the two devices so they are pointed directly at each other (page E-100).</li> <li>3. Move the sending and receiving devices away from the source of the problem.</li> <li>4. Avoid infrared data communication in direct sunlight.</li> </ol>

# MESSAGES

---

## Can't play PANORAMA

This message appears when there is not enough memory to perform panorama recording. Delete some images from the memory card to make room for the new image.

---

## CF ERROR You must format the CompactFlash card before using it with this camera.

### FORMAT→MENU

Perform the following procedure whenever a memory card starts to behave abnormally.

#### Important!

The procedure described below deletes all images stored in the memory card. Make sure all of your important images are backed up onto a computer hard disk or other storage medium before performing this procedure.

#### To reformat a memory card

1. Connect the AC adaptor to the camera and switch to AC power or load a new set of batteries into the camera.
  - Power failure while a format operation is being performed aborts the reformat operation.
2. Press MENU.



3. Use [▼] and [▲] to select "Yes", and then press SET.
    - Select MENU if you want to abort the reformat procedure without deleting anything.
    - Completion of the format operation is indicated by the message "NO IMAGE" appearing on the monitor screen. This message also indicates that the memory card was formatted successfully.
- 

## MEMORY FULL Change quality or delete unneeded images.

Not enough memory for recording in the current quality mode. Change to another quality mode, or delete some images from the memory card (pages E-51, 88).

---

## MEMORY FULL Delete unneeded images.

- Not enough memory for further recording. Delete some images from memory card (page E-88).
  - DCIM folder or other file (page E-105) cannot be created due to insufficient memory when downloading data from a computer to the memory card. Use your computer to delete unneeded images to free up memory card space for the images you are downloading. You could also press the MENU button and format the memory card in the camera, but doing so deletes all image files currently stored on the memory card.
- 

## NO FORMAT

The memory card is not formatted. Format the memory card before trying to use it (page E-33).

---



There is no memory card installed in the camera.

---

## MESSAGES

---

**RECORD ERROR** This message appears when the image you are trying to record cannot be compressed for some reason. Try changing the angle of the camera to the subject.

---

**REPLACE BATTERY!** Battery power is low. Camera power turns off automatically shortly after this message appears.

---

**There are no images on this memory card!** No images are stored in memory card.

---

**This camera cannot display the image you selected!** The JPEG image file you are trying to display is either corrupted or is a format that is not compatible with this camera.

---

# SPECIFICATIONS

- Description** ..... Digital camera
- Model** ..... QV-2000UX/Ir
- Recorded Image File Format** ..... Still images (including panoramas): JPEG (Exif. Ver. 2.1), DCF standard (design rule for camera file system), DPOF compatible, Movies: AVI
- Recording Medium** ..... CompactFlash card (Type I/II)
- Recorded Image Size** ..... 1600 x 1200 pixels, 800 x 600 pixels

## Standard Memory Capacity, Number of Image Files, Computer Output Image Size

Static		
1600 x 1200	FINE	71/8 images (850KB / image)
	NORMAL	97/9 images (600KB / image)
800 x 600	ECONOMY	163/15 images (350KB / image)
	FINE	225/22 images (200KB / image)
	NORMAL	277/29 images (150KB / image)
	ECONOMY	361/39 images (120KB / image)

**Movie: File Format AVI**

Approximate Total: 200 seconds / 25 seconds (300KB/second)

- The maximum length of normal movie recording is 30 seconds.
- The maximum length of a PAST movie is 10 seconds.

\* When using 64MB / 8MB CF card.

- Image Deletion** ..... Single image; all images in a folder; all images in memory (with image protection)
- Imaging Element** ..... 1/2-inch CCD (Total Pixels: 2.11 million, Effective Pixels; 2.02 million)

- Lens** ..... F2.0 to 2.8; f = 6.5 to 19.5mm (equivalent to 36 to 108mm lens for 35mm film)
- Zoom** ..... Optical zoom, 3X; Digital zoom: 6X (in combination with optical zoom)  
Image size is 800 x 600 pixels when digital zoom is used.
- Focusing** ..... Contrast-detect Auto Focus; manual focus with macro mode and focus lock
- Focus Range** ..... 0.5m to ∞ for Normal focus; 20cm to 50cm for macro (approximately 20cm to ∞ with manual focus), from surface of protective lens filter
- Exposure Control**  
Light Metering: ..... Multi-pattern, center point, spot by CCD  
Exposure: ..... Program AE, Shutter priority AE, Aperture priority AE  
Exposure Compensation: ..... -2EV to +2EV (1/3EV units)
- Shutter** ..... CCD electronic shutter; mechanical shutter, 1 to 1/800 second
- Aperture** ..... F2.0 to F11, auto switching or manual switching
- White Balance** ..... Automatic, fixed (4 modes), manual switching
- Self-timer** ..... 10 seconds, 2 seconds
- Built-in Flash**  
Flash Modes: ..... AUTO, ON, OFF, Red eye reduction  
Flash Range: ..... Approximately 0.5 to 4 meters

## SPECIFICATIONS

- Recording Functions** ..... One-shot, self-timer, movie, panorama, continuous, quick, macro, landscape, night scene, portrait
- Monitor** ..... 1.8" TFT, low-glare color HAST LCD (122,100 pixels, 555 x 220)
- Viewfinder** ..... LCD Monitor or optical viewfinder
- Clock** ..... Built-in quartz digital timepiece for time and date recording and storage with image data; auto calendar up to 2049
- Input/Output Terminals** .... DIGITAL IN/OUT, USB port (special mini port), AC adaptor connector, VIDEO OUT (NTSC, PAL)
- Infrared Communication** .. IrDA1.1; IrTran-P compliant
- Power Supply** ..... Four AA-size alkaline or lithium batteries  
Four AA-size nickel-hydrogen rechargeable batteries (NP-H3)  
AC adaptor (AD-C620)

### Battery Life

The values noted below indicate the number of hours before battery failure under normal operating temperature (25°C). These values are for reference only, and do not guarantee that any particular set of batteries actually will provide the service life indicated. Low temperatures shorten battery life.

Type of Operation	AA-size Alkaline Batteries LR6	AA-size Lithium Batteries FR6
Continuous Playback	Approximately 170 minutes	Approximately 290 minutes
Continuous Recording	Approximately 380 shots	Approximately 920 shots

- The above guidelines are based on the following battery types:  
Alkaline: MX1500 (AA) DURACELL ULTRA  
Lithium: Energizer
- Battery life varies with brand

Continuous recording values show the number of shots without using the flash. The number of shots depends on use of the flash and whether flash is turned on or off.

**Power Consumption** ..... Approximately 6.6W

**Dimensions** ..... 129.5(W) x 75(H) x 61(D) mm

**Weight** ..... Approximately 315g  
(excluding batteries)

**Standard Accessories** ..... 8MB COMPACTFLASH memory card; strap; soft case; USB cable; video cable; data transfer cable; CD-ROM; four LR6 alkaline batteries; Basic Reference, Bundled Software user's Manual

## SPECIFICATIONS

- This camera does not have a separate battery to power its clock. Clock settings are cleared whenever power to the camera is cut off (by batteries going dead while the camera is not connected to an AC power outlet with the AC adaptor) for about 24 hours. After power is resumed, either by loading fresh batteries or connecting to an AC power outlet, you will have to set the correct time and date again.
- The liquid crystal panel built into this camera is the product of precision engineering, with an effective pixel rate of 99.99%. This also means, however that 0.01% of the pixels can be expected to fail to light or to remain lit at all times.