



GETTING STARTED: DO THIS FIRST!

FIRST,

- **Before you can take advantage of the Caller ID and Call Waiting features, you must subscribe to these services from your local telephone company.**
- Name and number caller ID only work in conjunction with service provided by your local telephone company.

SECOND, after unpacking your new cordless phone:

CHARGE THE HANDSET BATTERY!

- **Set your new phone in an out-of-the-way place near a power outlet where it will not be disturbed. Do not connect it to the telephone line.**
- Plug the AC adaptor into the wall outlet.
- Plug the AC adaptor cord into the power jack on the base unit. The "POWER" LED should light. If not, see "**TROUBLESHOOTING,**" page 66.
- Take the covers off the handset and base unit battery compartments, place one battery pack in each compartment, being sure that the metal terminals on the batteries are in contact with the connectors in their respective compartments, and replace the cover on each compartment.
- Place the handset into the base unit's charging cradle. The "CHARGE" LED should light.
- The battery charging period has now started. From now until the 12 hour period is complete, do not let anything cause the handset to be removed from electrical contact with the base unit's charging pins or power to be removed from the base unit.

THIRD, after completing the 12 hour charge period, connect the base unit to the telephone line modular jack, using the six foot long modular line cord.

Now, set the Tone/Pulse switch for your type of service according to the instructions on page 22 and your telephone is ready for normal use. Information on the use of other features follows on page 23.

TABLE OF CONTENTS

IMPORTANT SAFETY INSTRUCTIONS	4
INTRODUCTION	7
Features	7
Parts identification	8
INSTALLATION	10
Installing the handset battery pack	10
Installing the base unit battery pack	11
Setting up the base unit	12
AC adaptor information	13
Wall mounting	14
Charging the battery packs	16
POWER FAILURE PROTECTION	17
LOCATION OF CONTROLS	18
Handset	18
Base unit	20
LCD	21
BASICS	22
Tone/Pulse selection	22
Setting or canceling the Auto Talk function	23
Any-key answer	24
Making a call	25
Last number redial	28
Banking and telephone services	28
Changing ringer volume	29
Changing the handset speaker volume	30
Paging the handset	31
Changing the security code	32
CALLER ID/CALL WAITING	33
Setting the area code	33
Changing and deleting the area code	35
Setting or canceling caller ID on call waiting	37
Answering a call	38
Call Waiting	42

TABLE OF CONTENTS

Caller ID memory44
Searching caller ID memory44
Storing to speed dial memory46
Dial out48
Deleting50
MEMORY DIALING53
Storing numbers53
Dialing a stored number58
Changing and deleting stored number61
ADDITION65
Carrying the handset in the belt clip65
TROUBLESHOOTING66
SPECIFICATIONS69
Handset69
Base unit69
Supplied accessories70
WARRANTY/SERVICE71

IMPORTANT SAFETY INSTRUCTIONS

When using your telephone equipment, basic safety precautions should always be followed to reduce the risk of fire, electric shock and injury.

- 1 Read and understand all instructions.
- 2 Follow all warnings and instructions marked on the product.
- 3 Unplug this product from the wall outlet before cleaning. Do not use liquid cleaners or aerosol cleaners. Use a dry cloth for cleaning.
- 4 Do not use this product near water, for example, near a bath tub, wash bowl, kitchen sink, or laundry tub, in a wet basement, or near a swimming pool.
- 5 Do not place this product on an unstable cart, stand, or table. The telephone may fall, causing serious damage to the telephone.
- 6 Slots and openings in the cabinet and the back or bottom are provided for ventilation, to protect it from overheating, these openings must not be blocked or covered. The openings should never be blocked by placing the product on a bed, sofa, rug, or other similar surface. This product should never be placed near or over a radiator or heat register. This product should not be placed in a built-in installation unless proper ventilation is provided.
- 7 Do not allow anything to rest on the power cord. Do not locate this product where the cord can be stepped on or tripped over.
- 8 Do not overload wall outlets and extension cords as this can result in the risk of fire or electric shock.
- 9 Never push objects of any kind into this product through cabinet slots as they may touch dangerous voltage points or short out parts that could result in a risk of fire or electric shock. Never spill liquid of any kind on the product.
- 10 Do not disassemble this product. Opening or removing covers puts you at risk of electrical shock, and incorrect reassembly can cause shocks, sparks or other damage during subsequent use.
- 11 Take this product to a qualified service technician under any of the following conditions:
 - A. When the power supply cord is damaged or frayed.
 - B. If liquid has been spilled into the product.
 - C. If the product has been exposed to rain or water.
 - D. If the product does not operate normally according to the operating instructions. Adjust only those controls covered by this manual. Improper adjustment of other controls may result in serious damage to the unit or your home.
 - E. If the product has been dropped or the cabinet has been damaged.
 - F. If the product exhibits a distinct change in performance.
- 12 Do not use the telephone in the vicinity of a gas leak.

IMPORTANT SAFETY INSTRUCTIONS

The RBRC™ Seal

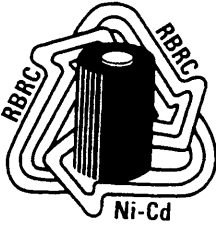

The RBRC™ Seal on the (easily removable) nickel-cadmium battery (contained in our product) indicates that Toshiba America Consumer Products, Inc. (TACP) is voluntarily participating in an industry program to collect and recycle these batteries at the end of their useful lives, when taken out of service within the United States. The RBRC™ program provides a convenient alternative to placing used nickel-cadmium batteries into the trash or municipal waste, which is illegal in some areas.

TACP's payments to RBRC™ make it easy for you to drop off the spent battery at local retailers of replacement nickel-cadmium batteries, or at authorized TACP product service centers. You may also contact your local recycling center for information on where

to return the spent battery. Please call 1-800-8-BATTERY for information on Ni-Cd battery recycling in your area. TACP's involvement in this program is part of its commitment to protecting our environment and conserving natural resources.

RBRC™ is a trademark of Rechargeable Battery Recycling Corporation.

IMPORTANT SAFETY INSTRUCTIONS

CAUTION: TO REDUCE THE RISK OF FIRE OR INJURY TO PERSONS BY BATTERY, READ AND FOLLOW THESE INSTRUCTIONS.

BATTERIES

- 1 Use only the appropriate type and size battery pack specified in the instruction manual provided for this product.
- 2 Do not dispose of the battery pack in a fire. The cell may explode. Check with State and local codes for possible special disposal instructions.
- 3 Do not open or mutilate the battery pack. Released electrolytes are corrosive and may cause damage to the eyes or skin. It may be toxic if swallowed.
- 4 Exercise care in handling the batteries. Contact with conductive materials such as rings, bracelets and keys may cause the battery to short out, resulting in overheating which could burn.
- 5 Charge the battery pack provided with or identified for use with this product only in accordance with the instructions and limitations specified in the instruction manual provided for this product.
- 6 Observe proper polarity orientation between the battery pack and battery charger.

ATTENTION: THE PRODUCT THAT YOU HAVE PURCHASED CONTAINS A RECHARGEABLE BATTERY. UNDER VARIOUS STATE AND LOCAL LAWS, IT MAY BE ILLEGAL TO DISPOSE OF THIS BATTERY INTO THE MUNICIPAL WASTE STREAM. PLEASE CHECK WITH YOUR LOCAL GOVERNMENT FOR DETAILS IN YOUR AREA REGARDING RECYCLING OPTIONS OR PROPER DISPOSAL.

SAVE THESE INSTRUCTIONS

TO HELP PROTECT THE ENVIRONMENT, THIS PRODUCT MAY CONTAIN RECYCLED OR RECONDITIONED PARTS AND MATERIALS.

INTRODUCTION

FEATURES

Toshiba America Consumer Products, Inc. takes pride in presenting the SX-2808BK digital cordless telephone. The Toshiba SX-2808BK handset features a 16-digit x 3-line dot matrix liquid crystal display (LCD) for caller ID on Call Waiting and speed dial programming and calling. The sleek new design provides face-up battery charging even when wall mounted. Other features are summarized below.



- 900 MHz Spread Spectram
- Paging from the base unit
- 50 Name and number caller ID-only works in conjunction with service provided by your local telephone company.
- Caller ID on Call Waiting is available if both services are subscribed to and provided by your local telephone company.
- 20-channel Auto scanning.
- 10-number speed dial.
- 7 days standby battery life
- Dual battery charging/power failure back-up. (Second battery included)

INTRODUCTION

PARTS IDENTIFICATION

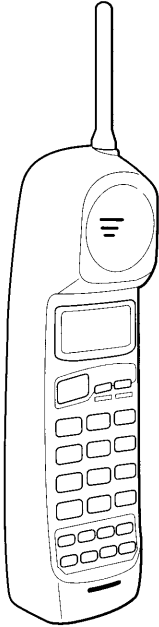

Handset

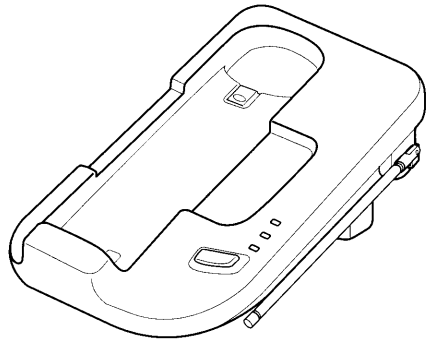

Base Unit

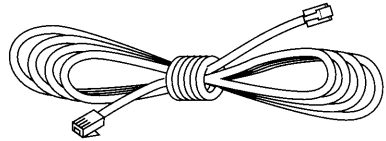

**6' Modular Line Cord
Part #.RC001861**

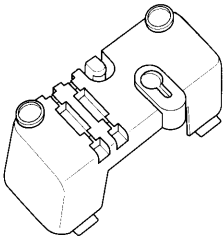

**Desk Top/Wall Mount Bracket
Part #.RC008854**

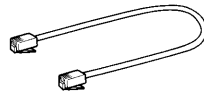

**6" Modular Line Cord
Part #.RC001872**

INTRODUCTION

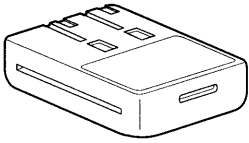

Rechargeable Battery Pack (2)
Toshiba TRB-8258
Part #.RC005634

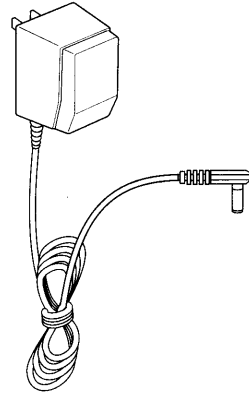

AC Adaptor
TAC-6700BK
Part #.RC003328



Owner's manual
Part #.RC008949

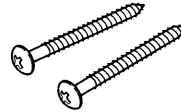

Screws (2)
(for the wall mount)
Part #.RC000936

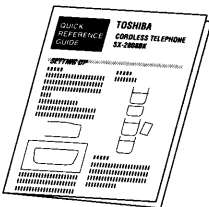

Quick Reference Guide
Part #.RC008950

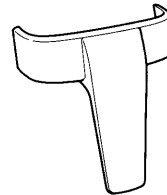

Belt Clip
Part #.RC008880

INSTALLATION

INSTALLING THE HANDSET BATTERY PACK

NOTE: Be sure to charge the handset 12-16 hours before use.

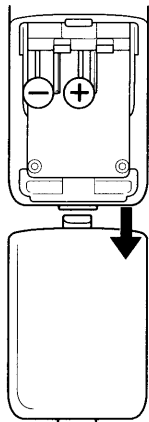

- 1** Remove the battery compartment cover on the back of the handset by sliding it down.

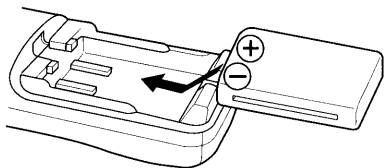

- 2** Place the battery pack in the battery compartment.

NOTE: Make sure to place the battery in the proper direction for correct polarity.

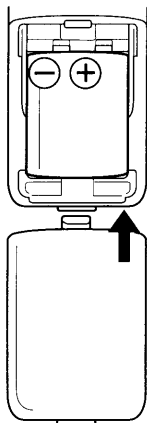

- 3** Put the battery compartment cover back in its original place by sliding it up until it clicks shut.

INSTALLATION

INSTALLING THE BASE UNIT BATTERY PACK

NOTE: Be sure to charge the base unit battery for 24 hours before use.

- 1** Place the battery pack in the battery compartment.

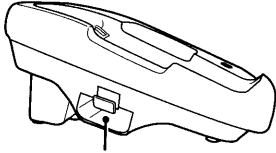

Battery compartment

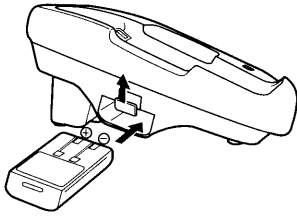

NOTES:

- Make sure to place the battery in the proper direction for correct polarity.
- When the battery power of the handset becomes low, replace it with the battery of the base unit.

INSTALLATION

SETTING UP THE BASE UNIT

For use on a desk or counter top follow the instructions below. For Wall Mounting directions, proceed to the following page.

MOUNTING THE BRACKET FOR DESKTOP INSTALLATION:

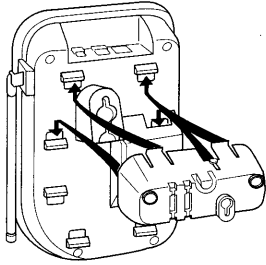

Snap the bracket (with the cutout facing down) into the 4 holders on the upper portion of the base unit's underside. Turn the base unit over and place it on a desk. See that the bracket is firmly mounted on the base unit.

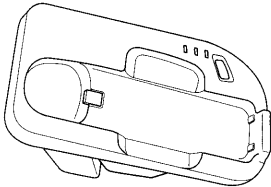

- 1** Make sure that your telephone jack is located near an electrical outlet. To ensure constant functioning, the outlet should not be controlled by a light switch. If the outlet is farther away, you may need an extension cord.

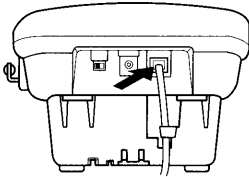

- 2** Plug one end of the telephone line cord into the back of the base unit in the slot labeled TEL LINE, and plug the other end into the telephone jack.

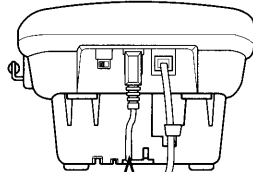

- 3** Insert the tip of the AC adaptor into the slot labeled DC IN 9V on the back of the base unit, and plug the other end into the electrical outlet.

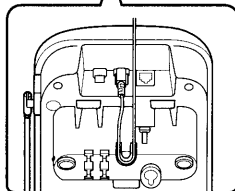

INSTALLATION

AC ADAPTOR INFORMATION

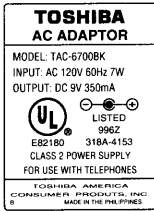

Use only the supplied AC adaptor, or one matching its specifications exactly, with this product. Incorrect voltage may damage the unit or cause it to malfunction.

INSTALLATION

WALL MOUNTING

This wall mounting system is designed to work with a standard wall jack plate with two protruding nail-like heads on either side of the jack opening. They are available at most phone or electronics retailers.

To mount the base on the wall using a baseboard jack, cut out the template on page 69 to position screws.

MOUNTING THE BRACKET FOR WALL INSTALLATION:

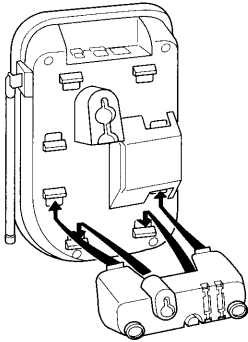

Fix the bracket vertically on the wall. Snap the bracket (with the cutout facing up) into the 4 holders on the lower portion of the base unit's underside.

- 1** Make sure that your telephone jack is located near an electrical outlet. To ensure constant functioning, the outlet should not be controlled by a light switch. If the outlet is farther away, you may need an extension cord.

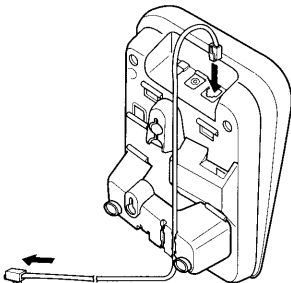
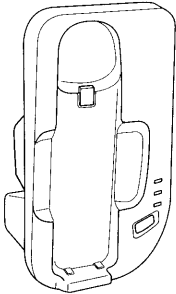

- 2** Plug one end of the telephone line cord into the back of the base unit in the slot labelled TEL LINE. Coil the excess cord and place it inside the bracket with the other end passed through the back opening.

INSTALLATION

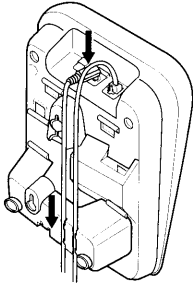

3 Insert the tip of the AC adaptor into the slot labelled DC IN 9V jack on the back of the base unit.

4 Position the AC adaptor cord through the channel on the back of the bracket.

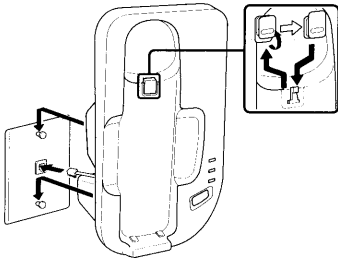

5 Position the base unit and bracket over the wall plate “screws”. Plug the line cord into the jack. Press the unit toward the wall and then down to secure it properly.

6 Remove the switch hook tab and flip it over as shown, then plug the AC adaptor into the electrical outlet.

NOTE: Use only the supplied AC adaptor, or one matching its specifications exactly, with this product. Incorrect voltage may damage the unit or cause it to function improperly. See page 13 for informations.

INSTALLATION

CHARGING THE BATTERY PACKS

If the battery of the handset drops to low power during the standby status, the “Low Battery” on the LCD blinks every 3 seconds and a short beep sounds every 3 seconds. All handset buttons are disabled.

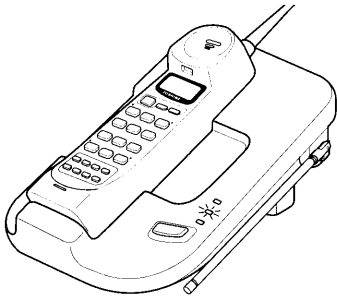

- 1** After installing the battery packs and setting up the base unit, place the handset in its cradle on the base unit.
- 2** The CHARGE LED lights to show that the handset is charging.

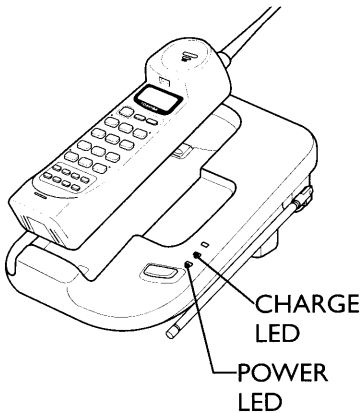

- 3** If the LED does not light, make sure the AC adaptor is plugged in securely and that the electrical outlet is working and not controlled by a light switch.

If the LED still does not light, verify that the charging contacts are clean and untarnished. Clean the contacts occasionally with a dry cloth.

NOTE: When the battery in the base unit is charged, the **POWER LED** lights in orange. When the battery is not charged, the **LED** lights in red.

POWER FAILURE PROTECTION

While the battery is installed in the base unit, normal operation can be maintained for a certain period even if a power failure occurs (only when the battery is charged). The POWER LED lights in different colors depending on the operation status.

- AC adaptor operation with the base battery: Lights in orange.
- AC adaptor operation without base battery: Lights in red.
- Base battery operation during a power failure: Lights in green.

LOCATION OF CONTROLS

HANDSET

BASIC OPERATION:

Liquid Crystal Display (LCD)

Displays the status of operation and other information. (See "LCD" in this chapter for details about the LCD.)

TALK button

Press to make a call, receive a call, or hang up after a call. (See pages 25 to 27)

* (TONE) button

If you have rotary/pulse service, press this button to perform temporary tone dialing for banking and other telephone services. (See page 28)

MEM (Memory) button

Press to dial Speed Dial numbers. (See page 53)

PAUSE button

Used to insert a pause (approximately 2 seconds) between dial numbers. When a pause is inserted, the LCD displays the letter "P".

FUNC (Function) button

Press to enter the Function Mode to perform various settings below. AUTO TALK ON/OFF, CIDCW ON/OFF, Area Code. (See pages 23, 37, 33)

DELETE button

Press to delete the last digit you entered. (See page 25) Also press to delete a stored number during deleting or changing of Speed Dial numbers. (See pages 61 to 64)

RDL button

Press to redial the last number dialed. (See page 28)

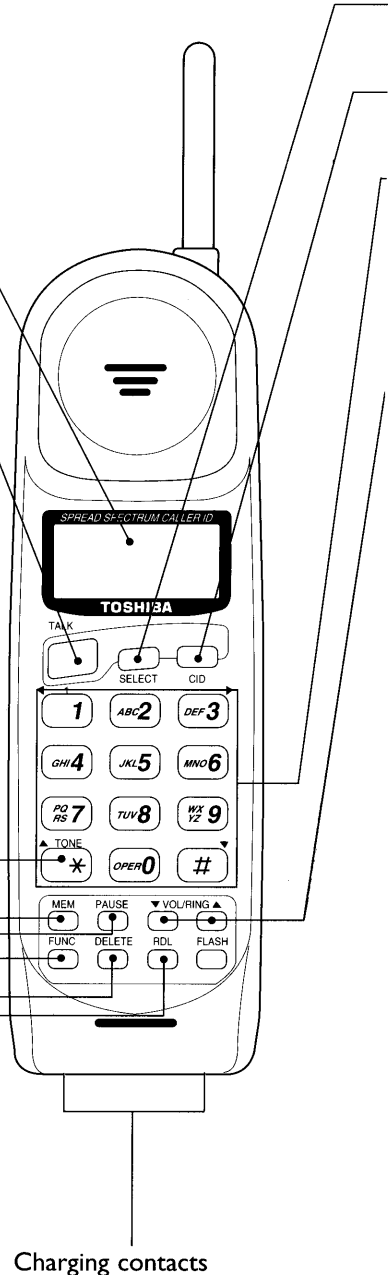

LOCATION OF CONTROLS

SELECT button

Press to select a data from caller ID memory on storing, editing, and deleting. (See pages 44 to 52)

CID (Caller ID) button

Press to store, edit, and delete a caller ID memory. (See pages 44 to 52)

Dialpad

Use to key in phone numbers.

VOL/RING button

Press to change the ringer volume. (See page 29)
Also used to change the handset speaker volume. (See page 30)

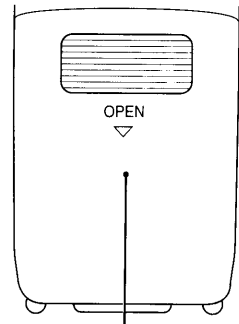

Battery compartment

Install the rechargeable battery pack here. Charge the battery for at least 12 hours whenever you install or replace it. (See page 10.)

CALLER ID/CALL WAITING OPERATIONS:

TALK button

Press to dial the displayed telephone number. (See page 48)

SELECT button

Press to select a data from caller ID memory on storing, editing, and deleting. Also used for setting the area code and other caller ID functions. (See pages 44 to 52)

CID (Caller ID button)

Press to store, edit, and delete a caller ID memory. (See pages 44 to 52)

1 button

Used for long distance dialing.

1 (◀) button (Left arrow button)

Used to switch displayed programmed names and numbers of the memory dial.

Used to move the cursor while storing and editing data in the memory.

3 (▶) button (Right arrow button)

Same as above.

*** (▲) button (up arrow button)**

Used to scroll up the display screen.

(▼) button (down arrow button)

Used to scroll down the display screen.

FLASH button

Used in conjunction with telephone company services, such as Call Waiting. Press to answer a Call Waiting call. (See pages 42, 43)

DELETE button

Press to delete a caller ID record. (See pages 50 to 52) Also used to delete the area code. (See page 36)

MEM (Memory) button

Press to store the caller ID data in speed dial memory. (See pages 46, 47)

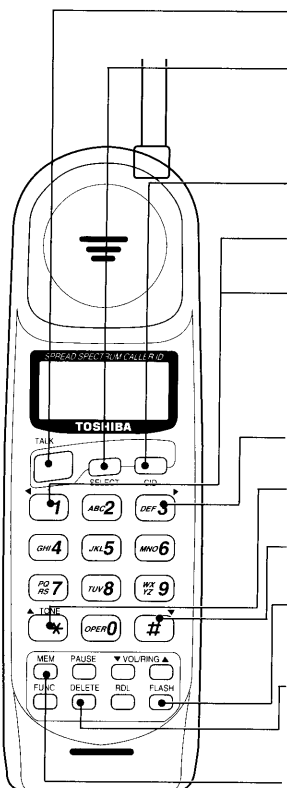

LOCATION OF CONTROLS

BASE UNIT

Tone/Pulse switch

Slide as required to set the telephone for tone or pulse dialing. (See page 22)

DC IN 9V jack

Connect the AC adaptor cord here. (See pages 12 to 15)

LINE modular jack

Plug in a modular cord here. (See pages 12, 14)

Cradle

Place the handset in here to charge the battery of the handset.

Battery compartment

Install the battery pack. (See page 11)

LEDs

IN USE LED

Lights during a call in progress

CHARGE LED

Lights when the handset is being charged.

POWER LED

Lights when the SX-2808BK is turned on. (See page 17)

PAGE button

Press to beep the handset. (See page 31)

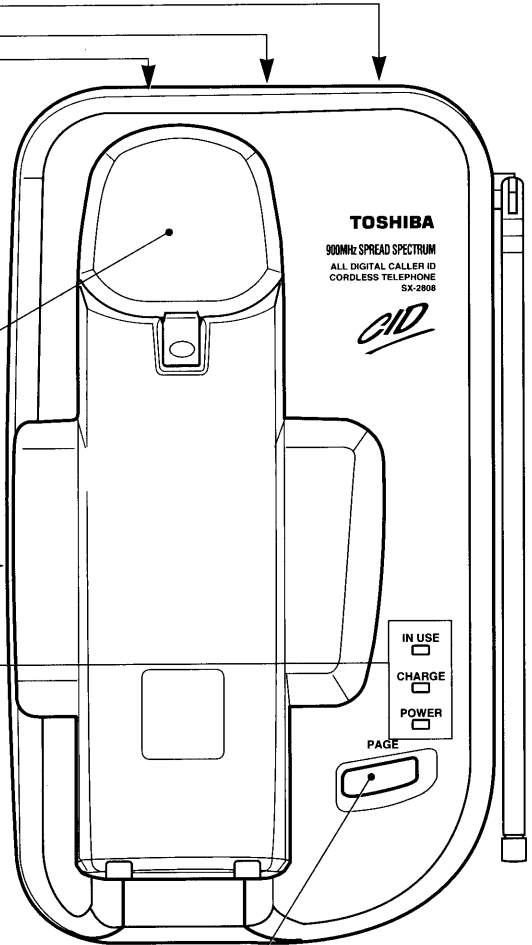

LOCATION OF CONTROLS

LCD

Dot matrix display

16 digits by 3 lines dot matrix LCD. Shows the time, caller ID, memory location, instructions, error messages, and other information.

The back light of the LCD operates in the following manner:

- Turns on during an incoming CID call.
- Turns on for 5 seconds and then off
 - when a button is pressed (except in battery low status).

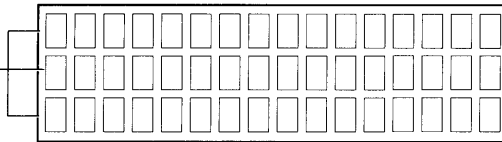

Caller ID indication example

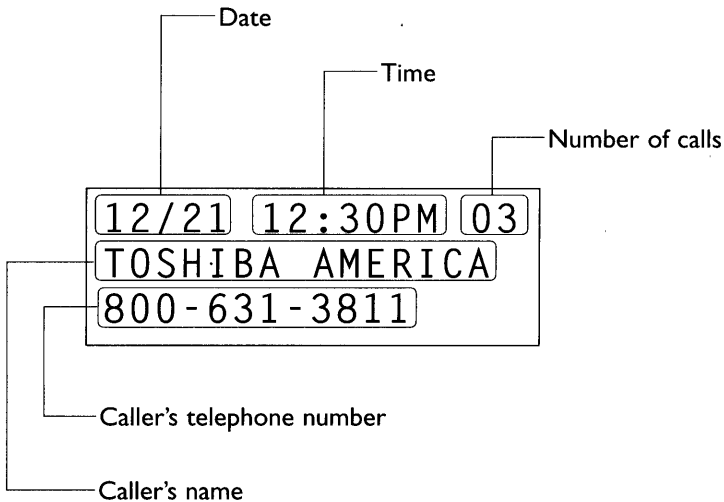

BASICS

TONE/PULSE SELECTION

Set the Tone-Pulse switch at the back of the base unit for the type of service you have, tone or pulse. If you are not sure which type of service you have:

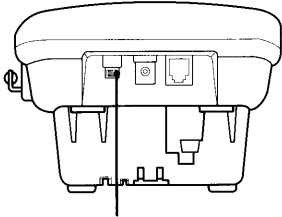

TONE/PULSE switch

- 1** Slide the Tone/Pulse switch to Tone.
- 2** Press the **TALK** button on the handset and listen for a dialtone.
- 3** Press any number other than 0. If the dial tone stops, you have Tone service. If the dial tone continues, you have Pulse service.
- 4** If you have Pulse service, set the Tone/Pulse switch to Pulse.

SETTING OR CANCELING THE AUTO TALK FUNCTION

You can enable or disable the Auto Talk function.

When the Auto Talk function is set to ON, the Auto Talk and Any-key Answer functions are automatically set to ON. If the handset is placed in its cradle on the base unit, you can answer a call by simply lifting the handset from its cradle (Auto Talk). If the handset is not placed in its cradle, you can answer a call by pressing the **(TALK)** button or any one of the buttons on the dialpad (Any-key Answer function).

When the Auto Talk function is set to OFF, you can lift the handset and view the caller ID information before choosing to answer. This function is preset to OFF at the factory prior to shipment.

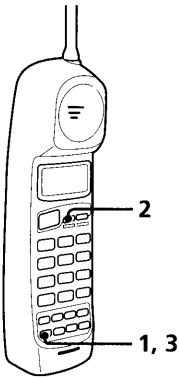

- 1 Press the **(FUNC)** button. The LCD displays the current setting.

LCD

```
1▶Auto Talk:Off
2 CIDCW      :On
3 Area Code :
```

- 2 Press the **(SELECT)** button. Each time you press the **(SELECT)** button, the On/Off setting will be switched.

LCD

```
1▶Auto Talk:Off
2 CIDCW      :On
3 Area Code :
```



```
1▶Auto Talk:On
2 CIDCW      :On
3 Area Code :
```

BASICS

- 3 Press the **(FUNC)** button. Confirmation beeps are emitted and the handset is put in standby status.

ANY-KEY ANSWER

When the Auto Talk feature is set to ON, the Any-Key Answer function is automatically set to ON.

The Any-Key Answer function allows you to answer a call by pressing the **(TALK)** button or any one of the buttons on the dialpad when the handset is not placed in the cradle.

MAKING A CALL

ON-HOOK DIALING:

Use the following procedure to dial a number by lifting the handset from its cradle on the base unit.

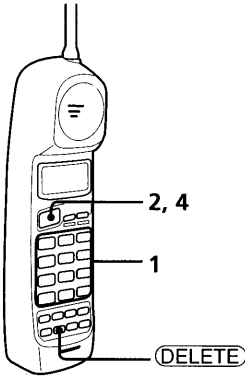

- 1** Key in the phone number you are calling (max. 32 digits). The LCD displays the entered digits in order from the left.

LCD

1234567890123456
789

If you enter a wrong digit, press the **DELETED** button.

- 2** Press the **TALK** button. The “talk” blinks while the connection is made to the base unit.

LCD

Talk
1234567890123456
789

- 3** When the connection is made, the LCD displays the entered digits. Then, begin speaking.

BASICS

After about 5 seconds, the LCD displays the duration of the call.

LCD

Talk 0:00
1234567890123456
789

- 4** To hang up, press the **TALK** button again or place the handset in its cradle on the base unit. The duration of a call is displayed for about 5 seconds when the call is ended.

LCD

5:08

NOTES:

- If you press the **TALK** button while the handset is connected to the base unit, the handset is put in the standby status.
- If the handset is too far away from the base unit, warning beeps will sound. The handset returns to standby mode.
- If you press and hold the **DELETE** button for 1 second or more, you can cancel all entered digits.

OFF-HOOK DIALING:

Use the following procedure to dial a number by lifting the handset from its cradle on the base unit.

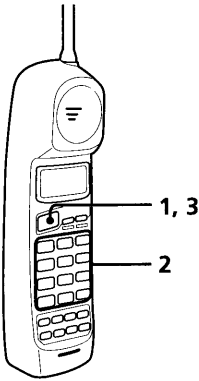

1 Press the **TALK** button. The “talk” blinks while the connection is made to the base unit.

2 Key in the phone number you are calling. The LCD displays the entered digits in order from the left. Then, begin speaking.

LCD

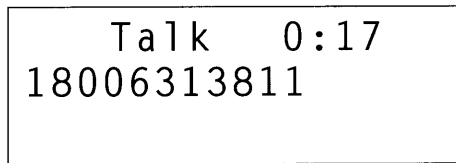

3 To hang up, press the **TALK** button again or place the handset in its cradle on the base unit. The duration of a call is displayed for about 5 seconds when the call is ended.

LCD

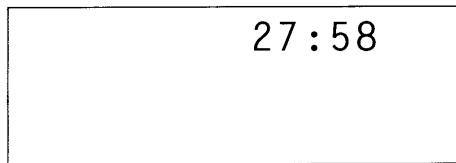

NOTES:

- If the handset battery becomes weak during conversation, warning beeps will sound every 3 seconds. Finish the call as soon as possible and return the handset to the base unit for recharging.
- If the handset cannot disconnect the line due to a power failure, remove the battery completely and install it after power is restored. Then place the handset on the base. The handset returns to standby mode.

BASICS

LAST NUMBER REDIAL

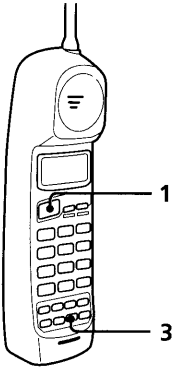

To redial the last number that you called on the handset:

- 1** Press the **TALK** button.
- 2** Wait for the dialtone.
- 3** Press the **RDL** button.

NOTE:

The handset will redial only up to 32 digits even for a number that exceeds this limit.

BANKING AND TELEPHONE SERVICES

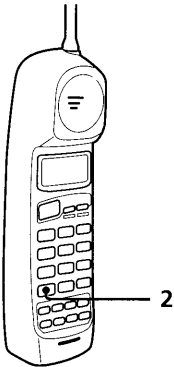

Even if you have PULSE dialing, you can use this phone with banking and other phone services requiring touch tone signals.

- 1** Dial the service number and wait for the connection.
- 2** Press the TONE ***** button on the handset and then enter the numbers required.
- 3** You will hear the tones on the line.

CHANGING RINGER VOLUME

Use the following procedure to set the ringer volume of the handset as desired.



- 1 Press the **VOL/RING** button to select the ringer volume High or Low while in the standby mode.

Each time you press the **VOL/RING** (**▼**) or (**▲**) button, the LCD will display the high and low setting screen.

LCD

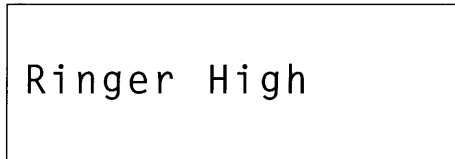

(Pressing the **VOL/RING** (**▲**) button)

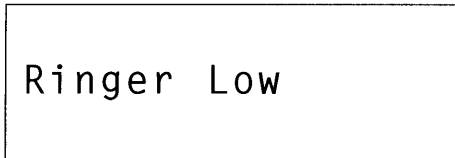

(Pressing the **VOL/RING** (**▼**) button)

After you select the ringer tone, the phone will ring using the selected sound for 2 seconds.

BASICS

CHANGING THE HANDSET SPEAKER VOLUME

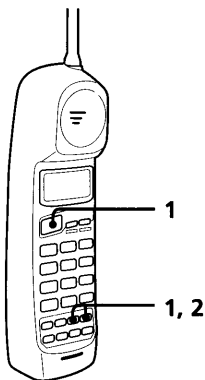

1 Press the **TALK** button and then press the **VOL/RING** button to set the handset speaker volume to high, normal or low while making a call.

2 Each time you press the **VOL/RING** (**▼**) or (**▲**) button, the LCD will display the settings one after another in the following order.

LCD

Volume High



Volume Normal



Volume Low

PAGING THE HANDSET

You can use the page function to help locate a misplaced handset or to alert the person who has the handset.

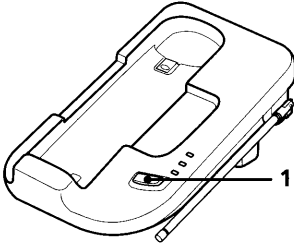

- 1 Press the **PAGE** button on the base unit to beep the handset.

The LCD displays the following message:

LCD

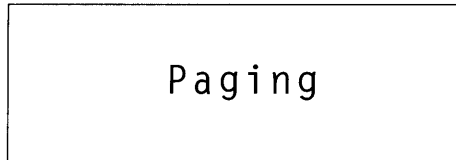

NOTES:

- If a call comes in during paging, you will hear the ring.
- If the handset has been lost for several days and the battery is completely discharged, the handset will not beep.
- When you press the **PAGE** button for a moment, the paging signal sounds for 20 seconds. To stop the paging signal, press the **PAGE** button again.

BASICS

CHANGING THE SECURITY CODE

A security code is assigned to the handset and base unit to enable connection between them. In other words, unless the security codes of the handset and base unit match, no connection can be made between them.

The digital security code is automatically set when you place the handset in its cradle on the base unit.

The following instructions for changing the security code are provided for your use in the rare event that such a change becomes necessary. This change should only be made when you are not making a call.

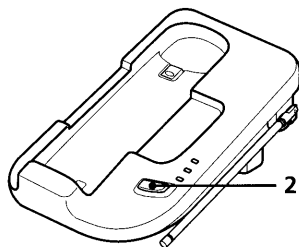

- 1** Locate away the handset from the base unit.
- 2** Press and hold the **PAGE** button of the base unit. The handset beeps and the LCD displays the message "Paging".

LCD

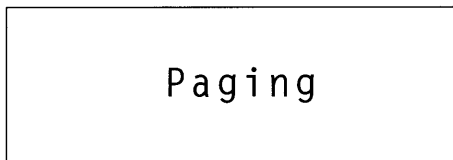

- 3** Place the handset in its cradle on the base unit with pressing the **PAGE** button, while the paging signal sounds. The message "Paging" disappears from the LCD and the paging signal stops.
- 4** Wait at least 3 seconds. The new security code is now set automatically.

NOTE: The security code of the handset and base unit is set to "00000" prior to shipment. When the handset is placed in its cradle on the base unit for the first time, the security code is set randomly from 65536 codes. As long as the handset and base unit retain the security code in their microprocessors, the same security code is used.

CALLER ID/CALL WAITING

- 4** Enter a 3-digit area code. For example, enter "615".

LCD

```
1 Auto Talk:Off
2 CIDCW      :On
3 Area Code:615
```

If you enter a wrong number, See page 35 "CHANGING AND DELETING THE AREA CODE".

- 5** Press the **(SELECT)** button. Confirmation beeps are emitted. The LCD displays the following message.

LCD

```
1 Auto Talk:Off
2 CIDCW      :On
3▶Area Code:615
```

- 6** Replace the handset in its cradle on the base unit.

NOTES:

- The caller information is stored on up to 50 different names.
- If the area code is 2 digits or less, the **(SELECT)** button is disabled and you cannot set the area code.
- Change your area code when you move to another location that has a different area code.
- Suppose your area code is "615" and you make a call to a number with the same area code, only the last 7 digits are dialed. During call back, however, the phone will include the area code "615" when it automatically redials the number. To avoid this problem, always set the area code so that the phone automatically excludes the area code when it is the same as that of the phone itself.

```
615-000-XXXX
```

Area code

CALLER ID/CALL WAITING

CHANGING AND DELETING THE AREA CODE

You can delete an area code or simply store another one in its place.

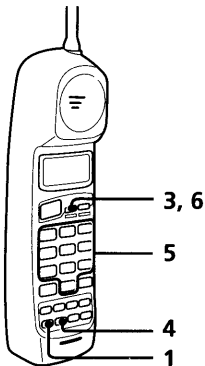

- 1 Press the **(FUNC)** button. The LCD displays the current area code.

LCD

```
1▶Auto Talk:Off
2 CIDCW      :On
3 Area Code:615
```

- 2 Press the **(#) (▼)** button to move the pointer to Area Code.

LCD

```
1 Auto Talk:Off
2 CIDCW      :On
3▶Area Code:615
```

- 3 Press the **(SELECT)** button. The Area Code setting screen is displayed. The pointer will be replaced by the cursor which appears at the first digit of the Area Code input field.

LCD

```
1 Auto Talk:Off
2 CIDCW      :On
3 Area Code:615
```

CALLER ID/CALL WAITING

- 4** If you press the **DELETE** button, the digit at the cursor position will be deleted. If you continue to hold the **DELETE** button about 1 second after this digit is deleted. After deleting all digits, the cursor will appear at the first digit position.

LCD

```
1 Auto Talk:Off
2 CIDCW      :0n
3 Area Code  :
```

- 5** To change an area code, enter a new 3-digit area code. If you do not want to set an area code, skip this procedure.

For example, enter "973".

LCD

```
1 Auto Talk:Off
2 CIDCW      :0n
3 Area Code  :973
```

- 6** Press the **SELECT** button. Confirmation beeps are emitted. The LCD displays the following message then the handset is put in standby status.

• When the area code is deleted

LCD

```
1 Auto Talk:Off
2 CIDCW      :0n
3▶Area Code:
```

• When the area code is changed

LCD

```
1 Auto Talk:Off
2 CIDCW      :0n
3▶Area Code:973
```

- 7** Replace the handset in its cradle on the base unit.

CALLER ID/CALL WAITING

SETTING OR CANCELING CALLER ID ON CALL WAITING

You can enable or disable the caller ID data reception during a call in progress. This function is preset to ON at the factory so that you will receive caller ID on Call Waiting when subscribing to both local telephone company services.

If you do not subscribe to these services, be sure to set this function to OFF.

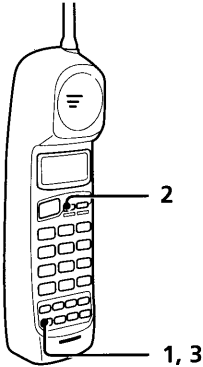

- 1 Press the **(FUNC)** button. The LCD displays the current setting.

LCD

```
1▶Auto Talk:Off
2 CIDCW      :On
3 Area Code :615
```

- 2 Press the **(#)(▼)** button to move the pointer to CIDCW and press the **(SELECT)** button. Each time you press the **(SELECT)** button, the On/Off setting will be switched.

LCD

```
1 Auto Talk:Off
2▶CIDCW      :On
3 Area Code :615
```



```
1 Auto Talk:Off
2▶CIDCW      :Off
3 Area Code :615
```

- 3 Press the **(FUNC)** button. Then the handset is put in standby status.
- 4 Replace the handset in its cradle on the base unit.

CALLER ID/CALL WAITING

ANSWERING A CALL

If you want the caller's name and his or her telephone number to be displayed when you receive a call, you must subscribe to the Caller ID service provided by your local telephone company.

The following messages will appear when a call is received during standby status.

If the LCD does not display any message when the phone rings for a third time, caller ID service is not applicable to this call.

WITH CALLER ID SERVICE

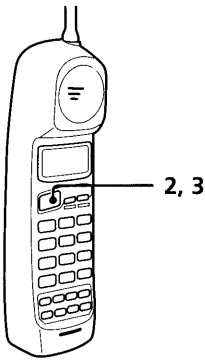

- 1 When the caller ID signal (telephone number and name data) is received successfully.

LCD

12/21 12:30PM 03
TOSHIBA AMERICA
800-631-3811

- 2 Before answering a call, check the telephone number and caller's name are displayed on the LCD. Press the **TALK** button to connect.

The "talk" blinks while the connection is made.

LCD

Talk-

When the connection is made, the LCD displays the duration of the call.

CALLER ID/CALL WAITING

LCD

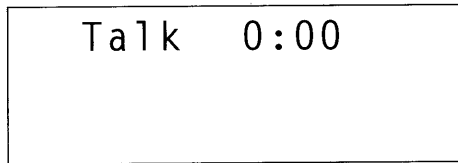

- 3** To hang up, press the **TALK** button or place the handset in its cradle on the base unit.

CALLER ID/CALL WAITING

WITHOUT CALLER ID SERVICE



2, 3

- 1 When no caller ID signal (telephone number and name data) is received during a current incoming call.

LCD

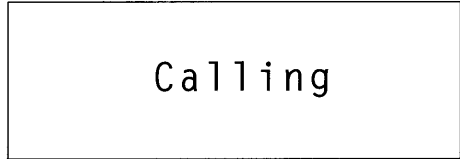

- 2 Press the **TALK** button to connect.

The "talk" blinks while the connection is made.

LCD

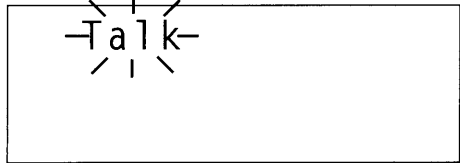

When the connection is made, the LCD displays the duration of the call .

LCD

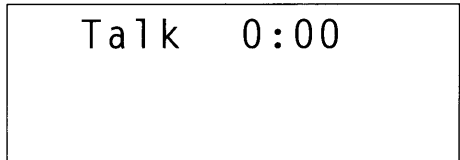

- 3 To hang up, press the **TALK** button or place the handset in its cradle on the base unit.

CALLER ID/CALL WAITING

NOTES:

- *If you do not answer an incoming call when the caller ID signal is received, the caller ID memory retains the telephone number and name of the caller. You can easily call back this number later by simply pressing the **(CID)** button (See page 44).*
- *If an error occurs in the data transmission between the base unit and handset, the LCD may not display the name and telephone number correctly.*
- *When a private number or private name is received, the LCD displays the message "Private Number" or "Private Name" respectively.*
- *When an unknown number or name is received, the LCD displays the message "Unknown Number" or "Unknown Name" respectively.*
- *When invalid data is received, the LCD displays the message "Line Error".*
- *When the Auto Talk function is set to ON, pick up the handset from its cradle on the base unit to receive a call. When the handset is not placed in its cradle, press the **(TALK)** button or any button on the dialpad to receive a call. (See page 23)*

CALLER ID/CALL WAITING

CALL WAITING

The LCD will show another incoming call even if you are currently engaged in a telephone conversation. This feature can be enabled or disabled. If enabled, it informs the user of a new incoming call by generating a short beep at regular intervals until the call is either answered, or the person calling hangs up. With call waiting on Caller ID, you can see who's calling to decide if you want to interrupt your current conversation.

If you want to use the Call Waiting feature, you must subscribe to the Call Waiting service provided by your local telephone company.

The following messages will appear when a call is received while you are engaged in a telephone conversation.

- a** When no caller ID signal (telephone number and name data) is received during Call Waiting (The information will not be displayed on the LCD.)

LCD

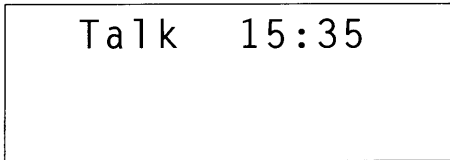

Talk 15:35

- b** When the caller ID signal (telephone number and name data) is received during Call Waiting

LCD

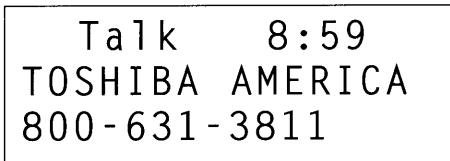

Talk 8:59
TOSHIBA AMERICA
800-631-3811

CALLER ID/CALL WAITING

WITH CALLER ID SERVICE

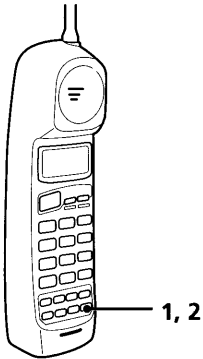

- 1** Before answering a call, check the telephone number and caller's name (are displayed in the screen). To switch to the waiting call, press the **FLASH** button on the handset. The first caller is put on hold.
- 2** To switch back to the first caller, press the **FLASH** button again.

Caller information, up to 50 different names, is stored.

If you do not answer an incoming call when the caller ID signal is generated, the caller ID memory retains the telephone number and name of a caller.

WITHOUT CALLER ID SERVICE



- 1** To switch to the waiting call, press the **FLASH** button on the handset. The first caller is put on hold.
- 2** To switch back to the first caller, press the **FLASH** button again.

NOTES:

- Pressing the **TALK** button will not access Call Waiting, it will disconnect the current caller.
- Pressing the **FLASH** button without having received a Call Waiting signal may disconnect the current caller.

CALLER ID/CALL WAITING

CALLER ID MEMORY

The SX-2808BK can display caller information consisting of the caller's telephone number, name (if supplied by local telephone company), time and the number of calls on the handset LCD. You can dial a displayed number or store the information in the Speed Dial memory.

SEARCHING CALLER ID MEMORY

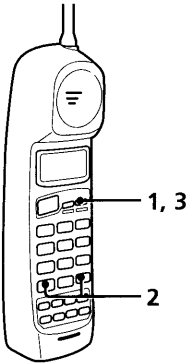

- 1 Press the **(CID)** button on the handset. If new caller ID data does not exist, the LCD will display the following message:

LCD

```
Total:02
```

If there is new caller ID data, the LCD will display the following message:

LCD

```
New :01  
Total:02
```

- 2 Press the **(#) (▼)** or **(* (▲)** button to display individual call records. The caller ID memory retains a listing of the 50 most recent callers.

LCD

```
1/7      9:30AM 12  
JOHN DOE  
555-2563
```

CALLER ID/CALL WAITING

To display the name and telephone number of the next caller ID data, press the **#** (▼) or ***** (▲) button.

If there is no more caller ID data when you press the **#** (▼) button, the LCD displays the following message.

LCD

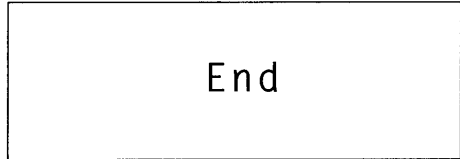

- 3** Press the **CID** button to return to standby status.

CALLER ID/CALL WAITING

STORING TO SPEED DIAL MEMORY

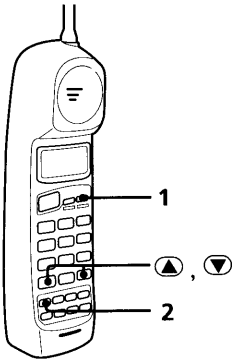

1 Press the **(CID)** button and **(#)** (**▼**) or **(*)** (**▲**) button to bring up the number you wish to transfer from caller ID information into Speed Dial memory.

2 Press the **(MEM)** button.

The LCD displays the following screen.

LCD

```
Select Location
1▶TOSHIBA AMERI
2 JOHN DOE
```

The names stored in memory locations 1 and 2 are displayed. The pointer (▶) appears next to the name in memory location 1.

3 Press the **(SELECT)** button to record the caller ID memory.

a If there is no data in the memory location number specified by the pointer (▶), confirmation beeps are emitted and the caller ID data is stored. The LCD returns to the Caller ID display screen.

b

(1) If there is data already in the memory location number specified by the pointer (▶), the LCD displays the following prompt (memory storage confirmation screen).

LCD

```
Replace Memory ?
Yes
▶No
```

The pointer (▶) is displayed at No.

CALLER ID/CALL WAITING

- (2) Press the * (▲) or # (▼) button to move the pointer to Yes (overwrite old data) or No (don't overwrite old data).
- (3) Press the **SELECT** button.

If Yes is selected:

Confirmation beeps are emitted and the new data overwrites the old caller ID data. The LCD returns to the Caller ID display screen.

If No is selected:

The LCD returns to the Caller ID display screen.

NOTES:

- If the telephone number is not displayed, the **MEM** button is disabled.
- When you call for long distance, press the number 1 button to add a "1" before pressing the **MEM** button.

CALLER ID/CALL WAITING

DIAL OUT

ON-HOOK DIALING:

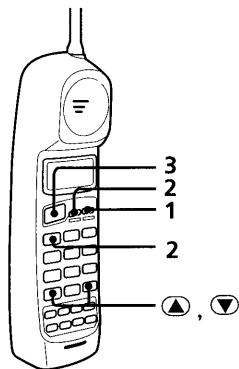

1 Press the **(CID)** button and **# (▼)** or **(* (▲)** button to bring up the number you wish to dial the displayed telephone number.

2 For long distance call

Press the number **(1)** button and the **(SELECT)** button.

The LCD displays the following screen.

LCD

```
TOSHIBA AMERICA
18006313811
```

For local call

Press the **(SELECT)** button.

The LCD displays the following screen.

LCD

```
TOSHIBA AMERICA
6313811
```

The name is displayed on the first line and the associated telephone number on the second line. The cursor appears at the last digit of the telephone number.

3 Press the **(TALK)** button.

NOTES:

- If the telephone number is not displayed, no number will be dialed.
- If the telephone number displayed exceeds 15 digits, error beeps are emitted when you press the number **(1)** button.

CALLER ID/CALL WAITING

OFF-HOOK DIALING:

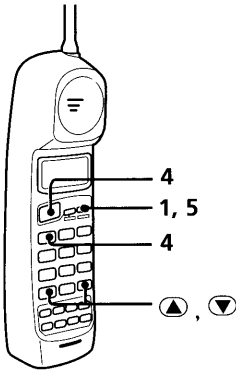

- 1 Press the **TALK** button and the **CID** button during a call. The LCD displays the following screen.

LCD

```
Talk    0:08
New     :01
Total  :02
```

<Example> One new caller ID data and two caller ID data are stored

- 2 Press the **#** (**▼**) button. The LCD displays the Caller ID data on the screen.

LCD

```
Talk    0:20
TOSHIBA AMERICA
8006313811
```

- 3 Press the ***** (**▲**) or **#** (**▼**) button to select the caller ID you want to dial.

- 4 **For long distance call**

Press the **1** button and the **TALK** button.

LCD

```
Talk    1:35
18006313811
```

For local call

Press the **TALK** button.

- 5 Press the **CID** button. The handset will return to normal talk mode.

NOTES:

- If the telephone number is not displayed, no number will be dialed.
- If the telephone number displayed exceeds 16 digits, error beeps are emitted when you press the number **1** button.

CALLER ID/CALL WAITING

DELETING

DELETE INDIVIDUAL CALLER ID DATA:

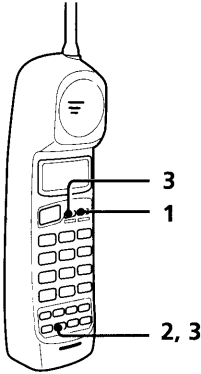

- 1** Press the **CID** button and **#** (**▼**) or ***** (**▲**) button to bring up the number you wish to delete a caller ID record from the memory.
- 2** Press the **DELETE** button. The LCD displays the confirmation screen for deletion of caller ID data.

LCD

Delete Message?
▶ Yes
No

Press the ***** (**▲**) or **#** (**▼**) button to select Yes or No.

- 3** Press the **SELECT** or **DELETE** button. If you select Yes, confirmation beeps are emitted and the LCD displays the next caller ID data. If there is no more caller ID data, the LCD displays the message "End".

If you select No, the LCD returns to the Call ID data screen.

Press the **CID** button to return to the standby status.

CALLER ID/CALL WAITING

DELETE ALL CALLER ID DATA:

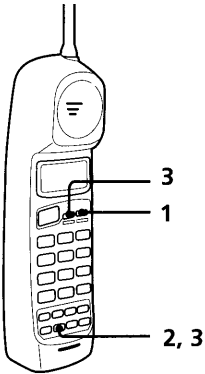

- 1 Press the **(CID)** button. The LCD displays the following screen.

LCD

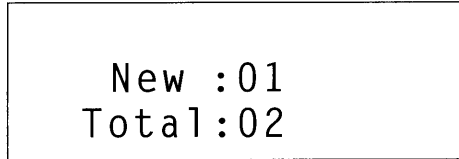

- 2 Press the **(DELETE)** button. The LCD displays the confirmation screen for deletion of all caller ID data.

LCD

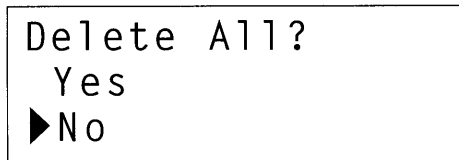

Press the **(*)** (▲) or **(#)** (▼) button to select Yes or No.

- 3 Press the **(SELECT)** or **(DELETE)** button.

If you select Yes, confirmation beeps are emitted and the LCD displays the total number of data deleted.

LCD

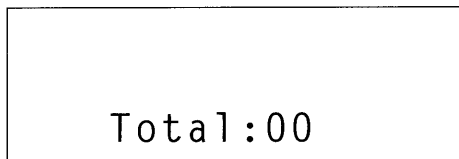

If you select No, the LCD returns to the screen indicating the number of Call ID data.

CALLER ID/CALL WAITING

LCD

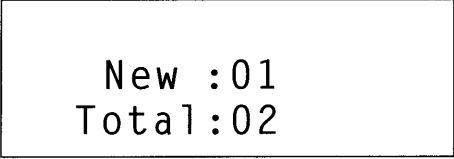

New :01
Total:02

Press the **(CID)** button to return to the standby status.

NOTES:

- *If you do not press either the **(*)** (**▲**), **(#)** (**▼**), **(TALK)**, **(SELECT)**, or **(DELETE)** button within 20 seconds after the caller ID mode is initiated, the handset is put in standby status.*
- *Up to 50 caller ID data can be stored in memory. When the data exceeds 50, the excess data is automatically deleted starting from the oldest one.*
- *When calls are attempted from the same telephone number, they are stored as one call recording the number of times received and the time of the most recent attempt.*
- *An incoming call without caller ID data is not stored in the memory.*

MEMORY DIALING

You can store frequently used telephone numbers and their names in the speed dial memory for convenient access. You can program them yourself or transfer them from the Caller ID memory.

You can store up to 10 telephone numbers and their associated names in the memory. Each number can have up to 20 digits including symbols (0 to 9, #, * / TONE, and PAUSE) which count as 1 digit each.

STORING NUMBERS

Remember that each number should be stored just as you would dial it manually. So for long distance calls, you may need 1, the area code and number, but for local calls, just the telephone number.

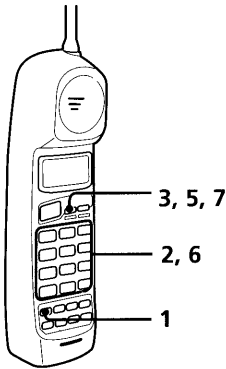

- 1 Press and hold the **MEM** button for 2 seconds.

The LCD displays the programmed names if the names already stored in memory.

LCD

```
Memory Store
1 ► TOSHIBA AMERI
2  JOHN DOE
```

The names stored in memory locations 1 and 2 are displayed. The pointer (►) appears next to the name in memory location 1.

- 2 Press the **#** (▼) or ***** (▲) button to move the pointer (►) to a free memory location number.

MEMORY DIALING

Example: Selecting memory location number 7

LCD



3 Press the **(SELECT)** button. The LCD displays the following screen.

LCD

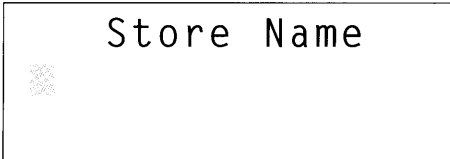

4 Enter a name of up to 14 characters.

Use the **(#)** (**▼**) or **(*)** (**▲**) button to enter a space, alphanumeric characters (uppercase and lower case), and special characters (*****, **#**, **&**, **'**, **(**, **)**, **,**, **-**, **.**, **:**, and **/**). Each time you press the down arrow button, the characters are displayed in the following order: a space → A → B → ... → Y → Z → a → b → ... y → z → 0 → 1 → 2 ... 9 → * → # → - → & → (→) → a space → A → ...

When you press the up arrow button, a space is displayed first, an arrow (→) displayed next, and the remaining characters follow in a reverse order.

To move the cursor to the right to change the entered character, press the **(3)** (**▶**) button. To move the cursor to the left, press the **(1)** (**◀**) button.

LCD

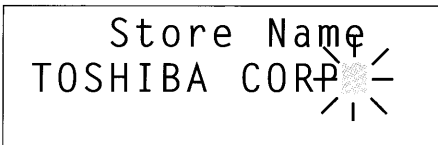

If you enter a wrong character for a name, use the left arrow or right arrow button to move the cursor to the character you want to correct and re-enter the correct character. Or, you can press the **(DELETE)** button to delete the entered character.

MEMORY DIALING

- 5** Press the **(SELECT)** button. The LCD displays the following screen.

LCD

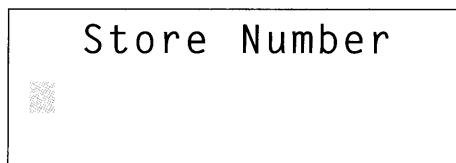

Store Number
█

- 6** Enter a telephone number to be stored.

Example: Enter "181334578400".

LCD

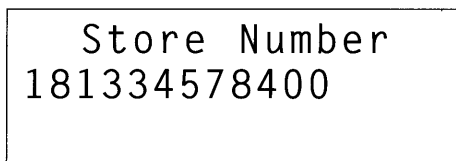

Store Number
181334578400

- 7** Press the **(SELECT)** button. Confirmation beeps are emitted and the LCD displays the following screen.

LCD

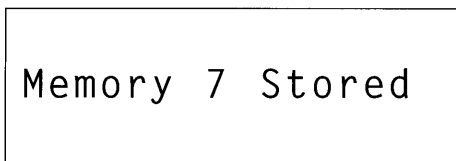

Memory 7 Stored

After 2 seconds, the LCD automatically returns to the programmed names of memory storage and edit/delete operations.

LCD

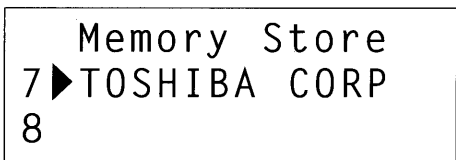

Memory Store
7▶TOSHIBA CORP
8

MEMORY DIALING

NOTES:

- *If you store a new telephone number in the same memory location (address number), the previously stored telephone number is automatically erased and overwritten with the new number.*
- *Always press a button within 20 seconds after pressing the previous button. Otherwise, the setting procedure will be canceled and the handset is put in standby status.*
- *If you receive a call during the storing operation or receive a pager call from the base unit, the operation is canceled.*
- *If you press and hold down the * (▲) or # (▼) button, you can skip the characters to be displayed to bring up the desired character quickly. In the same manner, you can press and hold the 1 (◀) or 3 (▶) button to jump to the desired character.*

MEMORY DIALING

LCD Indications

The table below summarizes the LCD status during storage and editing of memory dial data.

Status	Note	Indication example
Switching of programmed name and programmed number display	Each time you press the ① (\blacktriangleleft) and ③ (\blacktriangleright) button, the display switches.	<div style="border: 1px solid black; padding: 5px; margin-bottom: 10px;"> Memory Store 1 \blacktrianglerightTOSHIBA AMERI 2 JOHN DOE </div> <div style="text-align: center; margin-bottom: 10px;"> \updownarrow </div> <div style="border: 1px solid black; padding: 5px;"> Memory Store 1 \blacktriangleright18006313811 2 5552563 </div>
When there is no data in the memory	Blank	<div style="border: 1px solid black; padding: 5px;"> Memory Store 7 \blacktriangleright 8 </div>
When only the telephone number and no name is stored	The <Memory No> is displayed. (memory location number)	<div style="border: 1px solid black; padding: 5px;"> Memory Store 8 \blacktriangleright 9 <Memory 9> </div>
When the stored telephone number exceeds 15 digits	Up to 13th digits are displayed and the right arrow mark is displayed at the end. \downarrow To display the 14th and succeeding digits, press the ③ (\blacktriangleright) button.	<div style="border: 1px solid black; padding: 5px; margin-bottom: 10px;"> Memory Store 6 \blacktriangleright0118135543293\blacktriangleright 7 </div> <div style="text-align: center; margin-bottom: 10px;"> \downarrow </div> <div style="border: 1px solid black; padding: 5px;"> Memory Store \blacktriangleleft3000000 </div>

MEMORY DIALING

DIALING A STORED NUMBER

ON-HOOK DIALING:

Use the following procedure to dial by lifting the handset from its cradle on the base unit.

Note: You cannot dial a stored number when the handset is in its cradle on the base unit.

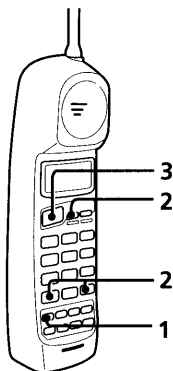

- 1 Press the **(MEM)** button.

The names stored in memory locations 1 to 3 are displayed. The pointer (▶) appears next to the name in memory location 3.

LCD

```
1 TOSHIBA AMERI
2 JOHN DOE
3▶MOMAND DAD
```

- 2 Press the **(#)** (▼) or **(*)** (▲) button to display the desired destination. If you want to display the telephone number, press the **(SELECT)** button. The LCD displays the name and telephone number.

LCD

```
MOMAND DAD
8175551212
```

Also you can switch the name and number display.

Press the **(3)** (▶) button to display the telephone number specified by the pointer (▶).

To return to the name display, press the **(1)** (◀) button.

MEMORY DIALING

3 Press the **TALK** button. The “talk” blinks while the connection is made to the base unit.

4 When the connection is made, the LCD displays the number.
After 5 seconds, the LCD begins showing the duration of the call.

LCD

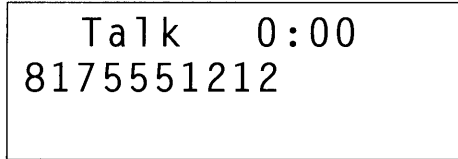

NOTE:

*If you press the **MEM** button while you are selecting a location, memory selection is canceled and the handset is put in standby status.*

MEMORY DIALING

OFF-HOOK DIALING:

Use the following procedure to dial by lifting the handset from its cradle on the base unit.

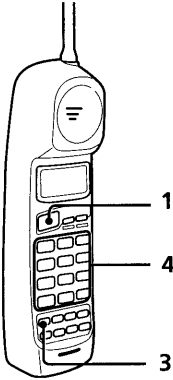

- 1 Press the **TALK** button. The “talk” blinks while the connection is made to the base unit.

LCD

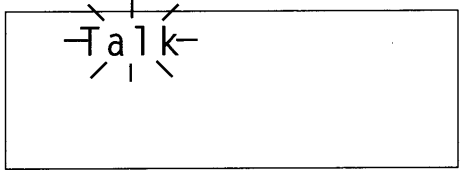

- 2 When the connection is made, the “talk” remains steady. After 5 seconds, the LCD begins showing the duration of the call.

LCD

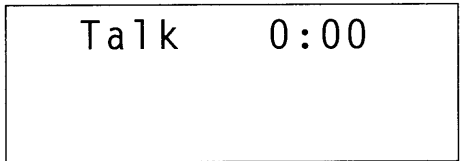

- 3 Press the **MEM** button.

- 4 Enter the memory dial number (0 to 9).

LCD

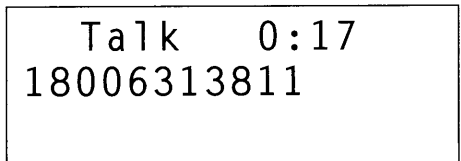

NOTE:

If you press a memory dial number which has not been programmed or if you press buttons other than 0 to 9 error beeps are emitted.

MEMORY DIALING

CHANGING AND DELETING STORED NUMBER

You can delete a number or simply store another one in its place. When you store a new phone number, the data stored in that memory location is deleted automatically.

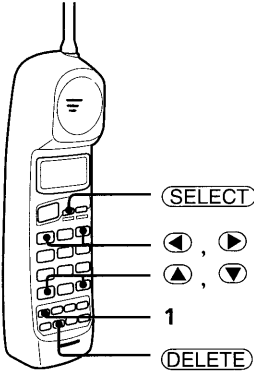

- 1 Press and hold the **MEM** button for 2 seconds.
The LCD displays the programmed names of memory storage and edit/delete operations.

LCD

```
Memory Store
1▶TOSHIBA AMERI
2 JOHN DOE
```

- 2 Press the **#** (▼) or ***** (▲) button to move the pointer (▶) you want to edit/delete.
- 3 Press the **SELECT** button. The LCD displays the Memory Store and Edit/Delete Memory screen for the specified memory location number.

LCD

```
▶Edit Memory 1
Delete Memory 1
Go Back
```

- 4 Press the **#** (▼) or ***** (▲) button to move the pointer (▶) to the desired function. To edit the stored data, select "Edit". To delete the data, select "Delete". To return to the previous screen, select "Go Back".

MEMORY DIALING

5 To store or edit data, go to step **a**. To delete data, go to step **b**.

a STORING OR EDITING THE NAME AND TELEPHONE NUMBER

(1) Press the **(SELECT)** button.

LCD

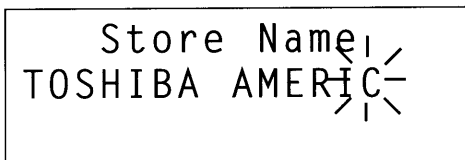

(2) Press the **(DELETE)** button to delete a character at the cursor position. At this time, the characters displayed on the right side of the cursor move to the left one by one. The cursor position does not move. However, if the cursor is located at a blank, it moves one character left.

LCD

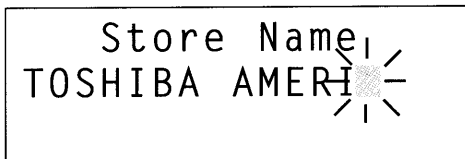

Use the **(*)** (**▲**), **(#)** (**▼**), **(1)** (**◀**), and **(3)** (**▶**) buttons to change the name. (See "Storing Numbers" on page 53 for instructions on how to enter names.)

(3) Press the **(SELECT)** button. The LCD displays the programmed numbers screen.

LCD

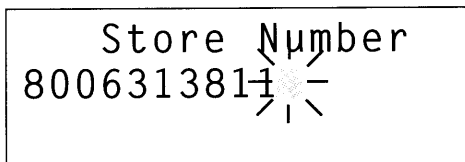

(4) Press the **(DELETE)** button. Each time you press this button, the digits of the telephone number are deleted one by one starting from the last digit.

MEMORY DIALING

- (5) After the number is entered or edited, press the **(SELECT)** button. Confirmation beeps are emitted and the LCD displays the following message.

LCD

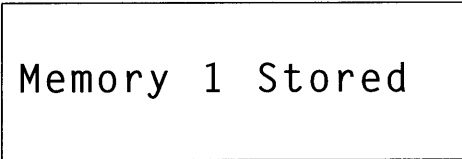

Memory 1 Stored

b DELETING THE STORED DATA

- (1) Press the **(SELECT)** button.

LCD

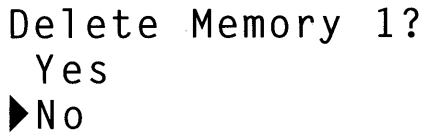

Delete Memory 1?
Yes
▶No

- (2) Press the **(*) (▲)** or **(#) (▼)** button to move the pointer to select Yes or No.
(3) Press the **(SELECT)** or **(DELETE)** button.

- If you select Yes, confirmation beeps are emitted and the LCD displays the number of deleted location.

LCD

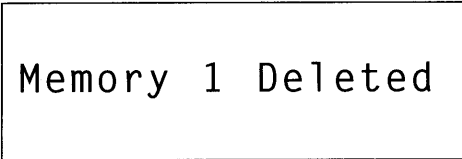

Memory 1 Deleted

- If you select No, the LCD returns to the programmed names screen.

LCD

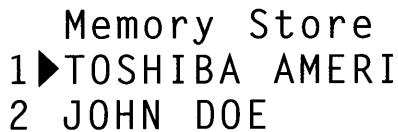

Memory Store
1▶TOSHIBA AMERI
2 JOHN DOE

MEMORY DIALING

NOTES:

- Always press a button within 20 seconds after pressing the previous button. Otherwise, the changing/deleting procedure will be canceled and the handset is put in standby status.
- If you receive a call during the changing/deleting operation or receive a pager call from the base unit, the operation will be canceled.
- If you press and hold the **DELETE** button for 1 second or more after deleting a character at the cursor position, you can delete all names and digits (no key beep is emitted).

CARRYING THE HANDSET IN THE BELT CLIP

You can attach the Belt Clip to the handset in order to carry it on your belt.

Attaching the Belt Clip to the Handset

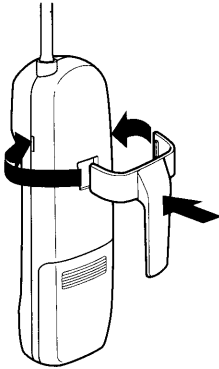

Insert the Belt Clip tabs firmly into the matching grooves on each side of the handset until they click.

NOTE:

Be sure to insert the tab properly to prevent the Belt Clip from falling off.

Removing the Belt Clip from the Handset

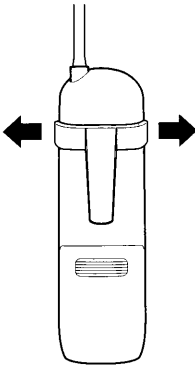

Pull both sides of the Belt Clip to release the tabs from the matching grooves.

NOTE:

Remove the Belt Clip carefully from the handset, taking care not to hurt your fingers or damage your nails.

TROUBLESHOOTING

Should any problem occur with the set, use the following simple tests to determine whether or not servicing is required.

If the problem persists after you have tried these tests, **call 1-800-631-3811 for Customer Service.**

Problem	Cause and Action
No dialtone. No calls come in.	<ul style="list-style-type: none">• The AC adaptor of the base unit is not plugged into the AC 120V outlet.• The battery is low. → Place the handset in its cradle on the base unit to recharge.• Telephone line cord is disconnected. → Check the wall telephone jack.• The previous call is not disconnected. → Press the (TALK) button to disconnect the line.• Trouble with the telephone line. → Check with another telephone.• The AC 120V outlet used is controlled by a wall switch in OFF position. → Relocate to different outlet.
Noise or interference.	<ul style="list-style-type: none">• The handset is too far from the base unit. → Bring the handset near the base unit.• The battery is low. → Place the handset in its cradle on the base unit to recharge.• The base unit is located in a place with high interference. → Relocate the base unit.• Interference from TV, appliances, etc. → Move away from the interference source.• There may be line noise. → Check with another telephone.
Battery peak goes low quickly.	<ul style="list-style-type: none">• The battery pack was not fully charged at the initial charging. Charge the battery pack for 12 to 16 hours without any interruption.• To avoid Ni-Cd battery memory effect, be sure to charge only as needed.• The battery needs to be replaced.

TROUBLESHOOTING

Problem	Cause and Action
The unit operates abnormally.	<ol style="list-style-type: none"> 1 Disconnect the AC adaptor. 2 After a few seconds, connect the AC adaptor again.
<ul style="list-style-type: none"> • During the standby status, the “Low Battery” blinks every 3 seconds, short beeps are emitted, and all handset buttons are disabled. • During a call in progress on the handset, the “Low Battery” blinks every 3 seconds and short beeps are emitted. All handset buttons except the TALK button are disabled (if you press the TALK button, all buttons are disabled). • During other operations other than the above, the operation is stopped and the handset is put in standby status. 	<p>The Battery is low.</p> <p>→ Place the handset in its cradle on the base unit to recharge the battery.</p>
<div style="border: 1px solid black; padding: 5px; width: fit-content;"> <p>12/21 12:30PM 03 TOSHIBA AMERICA Private Number</p> </div>	When a call is received along with a private number.
<div style="border: 1px solid black; padding: 5px; width: fit-content;"> <p>12/21 12:30PM 03 Private Name 800-631-3811</p> </div>	When a call is received along with a private name.
<div style="border: 1px solid black; padding: 5px; width: fit-content;"> <p>12/21 12:30PM 03 TOSHIBA AMERICA Unknown Number</p> </div>	When a call is received with an unknown number.

TROUBLESHOOTING

Problem	Cause and Action
<div data-bbox="120 240 537 379" style="border: 1px solid black; padding: 5px;">12/21 12:30PM 03 Unknown Name 800-631-3811</div>	When a call is received with an unknown name.
<div data-bbox="120 461 537 600" style="border: 1px solid black; padding: 5px;">Line Error</div>	When a call is received along with invalid data.
<p data-bbox="120 667 524 724">Does not receive the caller ID data on Call Waiting.</p> <div data-bbox="120 740 537 879" style="border: 1px solid black; padding: 5px;">Talk 8:59 TOSHIBA AMERICA 800-631-3811</div>	Check with your local telephone company.

SPECIFICATIONS

HANDSET

Frequency	904.20 - 925.80 MHz
Power Source	Customer Replaceable Ni-Cd Battery 600 mA ^H 3.6 V DC
Battery Life	7 days at Standby Mode, after proper initial charging cycle
Dimensions (H/W/D)	Approx. 7- ¹ / ₂ " X 2- ¹ / ₄ " X 1- ¹³ / ₁₆ inches (190 x 57 x 45 mm) Antenna Length 2- ¹ / ₂ inches (61 mm)
Weight	Approx. 9 oz (265 g)

BASE UNIT

Frequency	904.20 - 925.80 MHz
Power Source	AC 120 V 60 Hz/DC 9 V
Dimensions (H/W/D)	Approx. 3- ⁷ / ₈ " X 6- ³ / ₄ " X 9" (96 x 134 x 226 mm)
Weight	Approx. 1 lb 3 oz (535 g), battery pack included

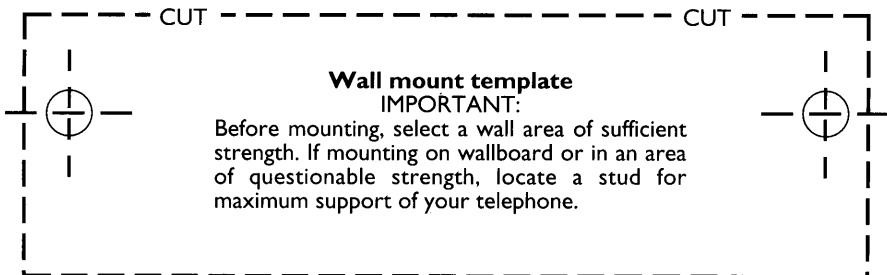

SPECIFICATIONS

SUPPLIED ACCESSORIES

Rechargeable Battery	(2)	TRB-8258	Part #. RC005634
AC Adaptor	(1)	TAC-6700BK	Part #. RC003328
Short Telephone Cord	(1)		Part #. RC001872
Long Telephone Cord	(1)		Part #. RC001861
Desk Top/Wall Mount Bracket	(1)		Part #. RC008854
Wall Mount Screw	(2)		Part #. RC000936
Belt Clip	(1)		Part #. RC008880
Owner's manual	(1)		Part #. RC008949
Quick Reference Guide	(1)		Part #. RC008950

For purchase of Accessories, please call **1-800-631-3811**.

WARRANTY/SERVICE

SERVICE REQUIREMENTS

If the cordless telephone should malfunction, all repairs will be performed by an authorized Toshiba Service Station. This unit has been registered with the FCC for direct connection to the telephone network. Under the FCC program, no customer is authorized to repair this unit. This applies to a unit both in and out of warranty. If an unauthorized repair is performed, the registration of the unit for direct connection to the network will be null and void. If the unit is still in warranty, the remainder of the warranty period will also be null and void.

It is the responsibility of users requiring service to report the need for service to the Toshiba dealer.

IMPORTANT INSTRUCTIONS TO USERS

Your telephone equipment has been designed and constructed to conform to federal regulations and can be connected to the phone line as described in this manual.

Please note that each product connected to the telephone line places a certain load on the line. We designate this as the unit's "Ringer Equivalence Number."

It is most unlikely, but...If your telephone equipment should cause problems on the phone line, the phone company has the right to temporarily discontinue your service. If this happens, the phone company will notify you and give you the opportunity to correct the problem. Also, you need to know that the phone company does have the right to make changes in their lines and/or equipment.

If these changes might affect your telephone equipment (or require changes in the telephone equipment or its connection), the phone company will notify you in writing, so you have the chance to take whatever action necessary to ensure uninterrupted phone service.

FCC REQUIREMENTS

You are no longer required by the FCC to notify your local telephone company of your intent to connect a new telephone. Your local telephone company may call you and request information about your phone such as: the brand name, model number, registration number, and ringer equivalence number. This information is provided on a label located at the bottom of the base unit and handset.

You may not directly connect your telephone equipment to coin telephone services. Check with your local telephone company if you wish to connect your telephone equipment to a party line service. Some party line services require a special adaptor or modification to your telephone.

It should be noted that some cordless telephones operate at frequencies that may cause interference to nearby TVs and VCRs; to minimize or prevent such interference, the base of the cordless telephone should not be placed near or on top of a TV or VCR; and, if interference is experienced, moving the cordless telephone farther away from the TV or VCR will often reduce or eliminate the interference.

WARRANTY/SERVICE

TELEPHONE/TELEPHONE ANSWER MACHINE LIMITED WARRANTY

Toshiba America Consumer Products, Inc. ("TACP") and Toshiba Hawaii, Inc. ("THI") make the following limited warranties. These limited warranties extend to the original consumer purchaser or any person receiving this set as a gift from the original consumer purchaser and to no other purchaser or transferee.

Limited One (1) Year Warranty of Parts and Labor

TACP/THI warrant this product and its parts against defects in materials or workmanship for a period of one year after the date of original retail purchase. During this period, TACP/THI will repair a defective product or part without charge to you. You must deliver the entire unit to a TACP/THI Authorized Service Station. You are responsible for all transportation and insurance charges for the unit to and from the Authorized Service Station. If you live in the Continental U.S.A. you may, at your option, forward your product for exchange to:

Toshiba America Consumer Products, Inc.
Returns Center
1420C Toshiba Dr.
Lebanon, TN 37087

You are responsible for all transportation and insurance charges for the product to the Returns Center. Products shipped to the Return Center must be insured and safely and securely packed, preferably in the original shipping carton, and a letter explaining the defect and also a copy of the bill of sale or other proof of purchase must be enclosed.

Upon receipt we will, at our option, exchange the unit with a new or refurbished unit.

Owner's Manual

You should read the owner's manual thoroughly before operating this product.

Your Responsibility

The above warranties are subject to the following conditions.

- (1) You must provide a copy of your bill of sale or other proof of purchase.
- (2) These warranties are effective only if the product is purchased and operated within the U.S.A or Puerto Rico.
- (3) Warranties extend only to defects in materials or workmanship as limited above and do not extend to any product or parts which have been lost or discarded by you or to damage to products or parts caused by misuse, accident, damage caused by Acts of God, such as lightning or fluctuations in electric power, improper installation, improper maintenance or use in violation of instructions furnished by us; or to units which have been altered or modified without authorization of TACP/THI or to damage to products or parts thereof which have had the serial number removed, altered, defaced or rendered illegible.
- (4) At your option, after the warranty period has expired in the U.S.A., call (800)-631-3811 to receive information concerning an exchange price. Payment must be enclosed with the product in the form of a certified check or money order and forward with your product to:
Toshiba America Consumer Products, Inc.
Returns Center
1420C Toshiba Dr.
Lebanon, TN 37087
- (5) Upon receipt we will, at our option, replace your unit with a new or refurbished unit of equal value. Features may not be identical to your original product.
- (6) Physically damaged product are not acceptable for repair or exchange within or after the warranty period expires and will be returned as received.
- (7) Any missing accessory components, (i.e., AC adaptor, line cord(s), battery, etc.), will be removed from the replacement unit being sent to you and packed with the defective unit you are returning.

WARRANTY/SERVICE

How to Obtain Warranty Service

In the event a problem should develop with your product, please proceed as follows:

(1) Arrange for the delivery of the product to the TACP/THI Authorized Service Station. Products Shipped to the Service Station must be insured and safely and securely packed, preferably in the original shipping carton, and a letter of explaining the defect and also a copy of the bill of sale or other proof of purchase must be enclosed. All transportation and insurance charges must be prepaid by you.

In The Continental United States contact: **In Hawaii contact:**



Toshiba Hawaii, Inc.
327 Kamakee Street,
Honolulu, HI 96814
(808)-521-5377

All warranties implied by state law, including the implied warranties of merchantability and fitness for a particular purpose, are expressly limited to the duration of the limited warranties set forth above. Some states do not allow limitations on how long an implied warranty lasts, so the above limitation may not apply to you. With the exception of any warranties implied by state law as hereby limited, the foregoing express warranty is exclusive and in lieu of all other warranties, guarantees, agreements and similar obligations of manufacturer or seller with respect to the repair or replacement of any product or parts.

In no event shall TACP or THI be liable for consequential or incidental damages. Some states do not allow the exclusion or limitation of incidental or consequential damages so the above limitation may not apply to you.

No person, agent, distributor, dealer, service station or company is authorized to change, modify or extend the terms of these warranties in any manner whatsoever. The time within which an action must be commenced to enforce any obligation of TACP and THI arising under this warranty or under any statute, or law of the United States or any state thereof, is hereby limited to one year from the date you discover or should have discovered, the defect. This limitation does not apply to implied warranties arising under state law. Some states do not permit limitation of the time within you may bring an action beyond the limits provided by state law so the above provision may not apply to you. This warranty gives you specific legal rights and you may also have other rights which vary from state to state.

IMPORTANT: PACKING AND SHIPPING INSTRUCTION

When you send the product to a service center, you should use the original carton box and packing material, then insert the original carton box containing the unit into another carton, using more packing material.

For technical assistance, purchase of accessories or service, please call 1-800-631-3811.

IMPORTANT

We suggest you record the following information and retain for your records along with your bill of sale or equipment document.

Model no. _____ **Serial no.** _____
Purchase date _____ **Dealer** _____
Dealer address _____

© 1998 TOSHIBA AMERICA CONSUMER PRODUCTS, INC.

QUICK REFERENCE GUIDE

TOSHIBA

ALL DIGITAL CALLER ID CORDLESS TELEPHONE SX-2808BK

For technical assistance, purchase of accessories or service, please call
1-800-631-3811.

Read the Owner's Manual for details.

SETTING UP

BASE UNIT

MOUNTING THE BRACKET:

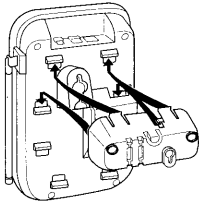

Snap the bracket (with the cutout facing down) into the 4 holders on the upper half under the base unit.

INSTALLING THE BATTERY PACK:

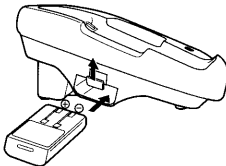

Install the battery pack in the battery compartment.

- This battery is used as a spare battery.
- This battery also functions as a backup during a power failure.

CONNECTION:

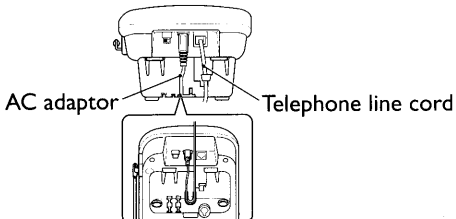

Plug the telephone line cord into the telephone line jack and to a telephone modular wall jack.

Insert the AC adaptor into the DC IN 9V jack and to an electrical wall outlet.

TONE/PULSE SELECTION:

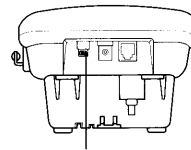

TONE/PULSE switch

Set the tone/pulse (PULSE-TONE) switch for the type of dialing service you have.

HANDSET

Install the battery pack in the handset.

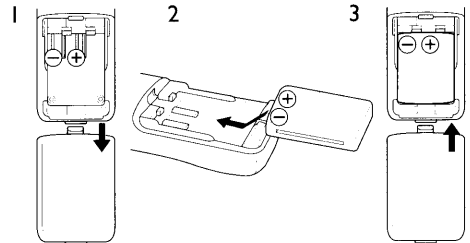

NOTE:

Make sure to place the battery in the proper direction for correct polarity.

IMPORTANT

Leave the handset on the base cradle telephone without interruption for 12 ~ 16 hours to achieve maximum battery charge.

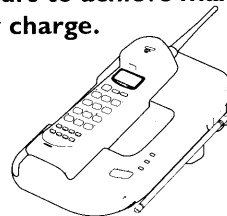

BASIC OPERATION

MAKING A CALL

ON-HOOK DIALING:

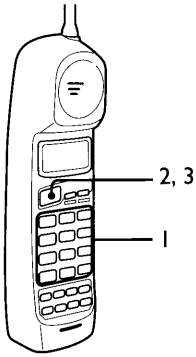

- 1 Key in the phone number you are calling (up to 32 digits). LCD shows entered digits.

LCD



- 2 Press the **TALK** button to dial out. The "talk" blinks and then the called number is displayed again. After 5 seconds, the LCD displays the duration of the call.
- 3 To hang up, press the **TALK** button again. The "talk" is turned off.

OFF-HOOK DIALING:

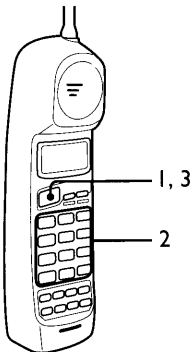

- 1 Press the **TALK** button. The "talk" blinks while the connection is made to the base unit.

- 2 Key in the phone number you are calling. LCD shows entered digits.

LCD

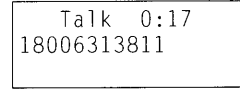

- 3 To hang up, press the **TALK** button again or replace the handset on the base unit cradle.

ANSWERING A CALL

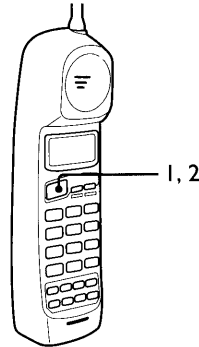

When you receive a call during standby status, and if you do not subscribe to Caller ID service with your local telephone company, the following message will appear.

LCD

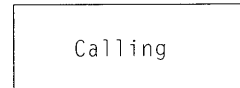

- 1 Press the **TALK** button to talk. After connection, LCD shows the "talk" and call duration counter.
- 2 To hang up, press the **TALK** button again.

CALLER ID SERVICE

To use this feature, you must subscribe to the caller ID service provided by your telephone company.

MAKING A CALL USING CID FEATURE

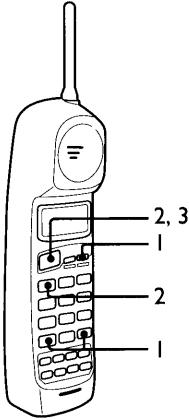

1 Press the **(CID)** button and **(#)** (**▼**) or **(*)** (**▲**) button to bring up the number you wish to dial the displayed telephone number.

2 For long distance call

Press the number **(1)** button.

The LCD displays the following screen.

LCD

```
12/21 12:30PM 03
TOSHIBA AMERICA
18006313811
```

Press the **(TALK)** button.

For local call

Press the **(TALK)** button.

3 To hang up, press the **(TALK)** button.

DELETING A CALLER ID RECORD

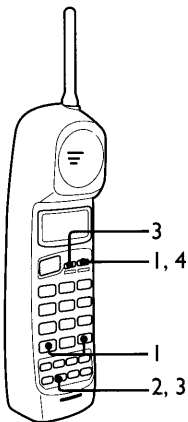

1 Press the **(CID)** button and **(#)** (**▼**) or **(*)** (**▲**) button to bring up the number you wish to delete a caller ID record from the memory.

2 Press the **(DELETE)** button. The LCD displays the confirmation screen for deletion of caller ID data.

LCD

```
Delete Message?
▶Yes
No
```

Press the **(*)** (**▲**) or **(#)** (**▼**) button to select Yes or No.

3 Press the **(SELECT)** or **(DELETE)** button. If you select Yes, confirmation beeps are emitted and the LCD displays the next caller ID data.

4 Press the **(CID)** button to return to the standby status.

ANSWERING A CALL

CALLER ID DURING STANDBY STATUS:

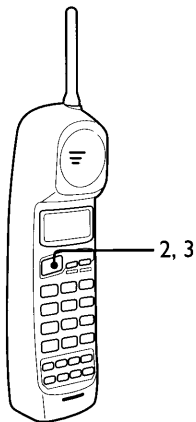

- 1 When you receive a call during standby status, the following message will appear when the caller ID signal is received.

LCD

```
12/21 12:30PM 03  
TOSHIBA AMERICA  
800-631-3811
```

- 2 Check the telephone number and caller's name. Press the **(TALK)** button to talk, LCD shows the talk icon and call duration counter.

LCD

```
Talk 0:00
```

- 3 To hang up, press the **(TALK)** button.

Note:

If you do not answer an incoming call when the caller ID signal is received, the caller ID memory retains the telephone number and name of the caller. You can easily call back this number later by simply pressing the **(CID)** button. (See "MAKING A CALL USING CID FEATURE.")

CALLER ID ON CALL WAITING:

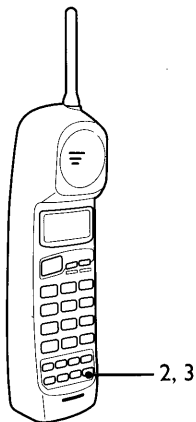

To use "Caller ID on Call waiting" you have to subscribe to both services with your telephone company.

- 1 When a new call comes in while you are already talking on the phone, you will hear a notification beep and the new caller's name and phone number appear on the LCD when the caller ID signal is received.

LCD

```
Talk 8:59  
TOSHIBA AMERICA  
800-631-3811
```

- 2 Check the telephone number and caller's name. To switch to the new call, press the **(FLASH)** button. The first caller is put on hold.
- 3 To switch back to the first caller, press the **(FLASH)** button again.

For more detailed instructions and examples, please refer to the owner's manual.