

MAINBOARD

User's Manual

Rev: 1.00

- * Product Name: 4D533
- * All other product names and trademarks or copyrights are belong to their respective owners.
- * Specifications and information contained in this manual are subject to change without notice.
- * Supports AGP 2.0 including **4x AGP (only)**

INTRODUCTION

Federal Communications Commission (F.C.C) Statement

This device complies with Part 15 of the FCC Rules. Operation of this device is subject to the following two conditions: (1) this device may not cause harmful interference, and (2) this device must accept any interference received, including interference that may cause undesired operation.

Accessories: This device has been tested and found to comply with the limits of a Class B digital device, the accessories associated with this equipment are as follows:

1. Shielded serial cable. (Can be obtained from multiple retail outlets)
2. Shielded printer cable. (Can be obtained from multiple retail outlets)
3. Shielded video cable. (Can be obtained from multiple retail outlets)
4. Shielded power cord. (Provided by manufacturer)

These accessories are required to ensure compliance with FCC Rules.

This equipment has been tested and found to comply with the limits of a Class B digital device, pursuant to Part 15 of the FCC Rules. These limits are designed to provide reasonable protection against harmful interference in a residential installation. This equipment generates, uses and can radiate radio frequency energy and, if not installed and used in accordance with the instructions, may cause harmful interference to radio communications.

There is no guarantee that interference will not occur in a particular installation.

If this equipment does cause harmful interference to radio or television reception, which can be determined by turning the equipment off and on, you are encouraged to try to correct the interference by one or more of the following measures:

1. Reorient / relocate the receiving antenna.
2. Increase the separation between the equipment and receiver.
3. Connect the equipment into an outlet on a circuit different from that to which the receiver is connected.
4. Consult the dealer or an experienced radio/TV technician for help.

Caution: Changes or modifications not expressly approved by the manufacturer could void the user's authority to operate the equipment.

INTRODUCTION

Disclaimer

The vendor makes no representations or warranties with respect to the contents here of and specially disclaims any implied warranties of merchantability or fitness for any purpose. Further the vendor reserves the right to revise this publication and to make changes the contents here of without obligation to notify any party beforehand.

Duplication of this publication, in part or in whole, is not allowed without first obtaining the vendor's approval in writing.

Trademarks and Remarks

MS-DOS, Windows, Windows NT, Windows 9x and Windows 2000 are products of Microsoft Corp, with its ownership of trademark, and are distributed by the Vendor under a license agreement.

All trademarks used in this manual are the property of their respective owners.

Canadian D.O.C Statement

This digital apparatus does not exceed the Class B limits for radio noise emissions from digital apparatus as set out in the radio interference regulations of the Canadian Department of Communications.



WARNING

- ☆ **When you installing AGP card, please make sure the following notice is fully understood and practiced. If your AGP card has “AGP 4X notch”(show below), please make sure your AGP card is AGP 4X (1.5V).**

- ☆ **Do not use AGP 2X card (3.3V) in this mainboard. It will burn and damage the mainboard due to Intel 82845 chipset can't support AGP 2X (3.3V).**

INTRODUCTION

Table of Contents

PACKAGE CHECKLIST

CHAPTER 1

1. INTRODUCTION OF 4D533 MOTHERBOARD.....	7
1.1 Product Description.....	7
1.2 System Block Diagram.....	8
1.3 Features & Specifications	9
1.4 Board Level Feature.....	10
1.5 Comprehensive Mainboard View	12
2. HARDWARE INSTALLATION	13
2.1 Jumper Setting	13
2.1.1 Setting the Jumpers	13
2.1.2 Clear CMOS.....	14
2.1.3 Flash BIOS Write Protect/Enable (JP4)	14
2.1.4 SMART Card.....	15
2.2 Connections.....	13
2.2.1 Installing the CPU	16
2.2.2 Installing the Heatsink and Fan.	17
2.2.3 Cooling Fan.....	18
2.2.4 Installing the Memory Modules (DIMM).....	19
2.2.5 Floppy Drives.....	20
2.2.6 IDE Hard Drivers and CD-ROMs Drives	20
2.2.7 Power LED Connections	21
2.2.8 Power Supply Connector	22
2.2.9 IrDA-Compliant Infrared Module Connector.....	22
2.2.10 LAN Wake-up Connector.....	23
2.2.11 External Connectors.....	23
2.2.12 Installing an AGP Card	27
2.2.13 Installing an PCI Card.....	27
2.2.14 Installing an CNR Card	28
2.2.15 Onboard LED.....	28
3. MAINBOARD BIOS SETUP.....	29
3.1 About the BIOS	29
3.2 Main Menu	31
3.3 Standard CMOS Features	32

INTRODUCTION

3.4 Advance d BIOS Features	36
3.5 Advance d Chipset Features	39
3.6 Integrated Peripherals	42
3.7 PC Health Status	46
3.8 Power Management Setup	48
3.9 PnP/PCI Configurations	51
3.10 Frequency / Voltage Control	53
3.11 Load Fail-Safe Defaults	54
3.12 Load Optimize Defaults.....	54
3.13 Supervisor Password and User Password Setting.....	54
3.14 Save & Exit Setup / Exit Without Saving	55
3.15 PCI Device Listing	56
4. FLASH BIOS PROGRAMMING UTILITY.....	57
5. DMI UTILITY.....	59
6. INSTANTLY AVAILABLE PC.....	60
6.1 What is an Instantly Available PC?	60
6.2 Core Technology Suspend to RAM (S3)	60
6.3 The Key Ingredients	61
6.4 Installation	62
6.5 Using Suspend t o RAM.....	63
6.6 Related Documents	64
7. SOFTWARE INSTALLATION.....	65
7.1 Please Select Model Name.....	65
7.2 Install 845 Drivers.....	66
7.3 Install Sound Drivers.....	68
7.4 Install LAN Driver.....	69
7.5 Install ADOBE Acrobat Reader V 4.0.....	70
7.6 Install IDE Drivers.....	71
7.8 Other Driver Search.....	73
8. Appendix.....	74
8.1 Update Your system	74
BIOS.....	

INTRODUCTION

Package Checklist

Your mainboard package should include the items listed below. Damaged or missing items should be reported to your vendor.

1. One mainboard
2. One User's Manual
3. Floppy disk ribbon cable for 3.5" floppy drive
4. 80 pin IDE ribbon cable for internal ATA100 or ATA66 IDE drive
(Note: The 80pin ribbon cable is designed with a 40pin connector.)
5. Support CD-ROM containing the following support software:
(The latest drivers can always be found at their respective web sites.)
Support software for updating the Flash BIOS

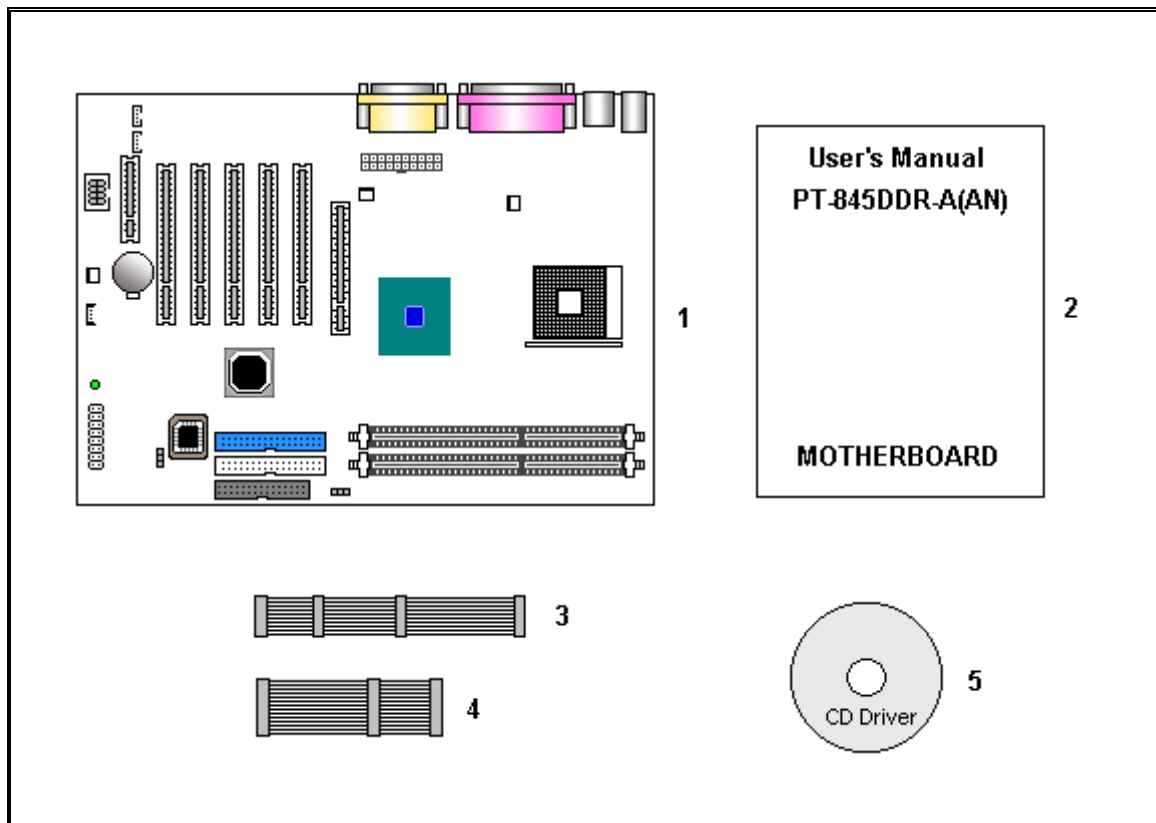

INTRODUCTION

1. INTRODUCTION

1.1 Product Description

This mainboard represents the highest level of technology available in PC Mainboards

today. Designed as a flexible, high-performance and cost-effective solution for System Integrators and End Users alike, this mainboard provides the power and expandability to meet the requirements of the most advanced operating systems and software applications.

This mainboard is a high performance Pentium based (FSB 400MHz) system.

Advanced hardware designs include ACPI's **Suspend to RAM** for the implementation of Instantly Available PCs. Also, by incorporating **CNR, 4X AGP, AC97, Super I/O, Ultra DMA/100 Bus Mastering IDE** and **Universal Serial Bus (USB)** onto the mainboard, optimum system performance is assured and system design and implementation is simplified.

Fully **Plug & Play** compatible via an Award BIOS, this mainboard facilitates easy system configuration and peripheral setup. Advanced BIOS features include **Intelligent Hardware Monitoring and Alert functions**. The Award BIOS also supports **ACPI** readiness and is compatible with **PC98** specification. This mainboard is the ideal foundation for high-end computer systems.

INTRODUCTION

1.2 System Block Diagram

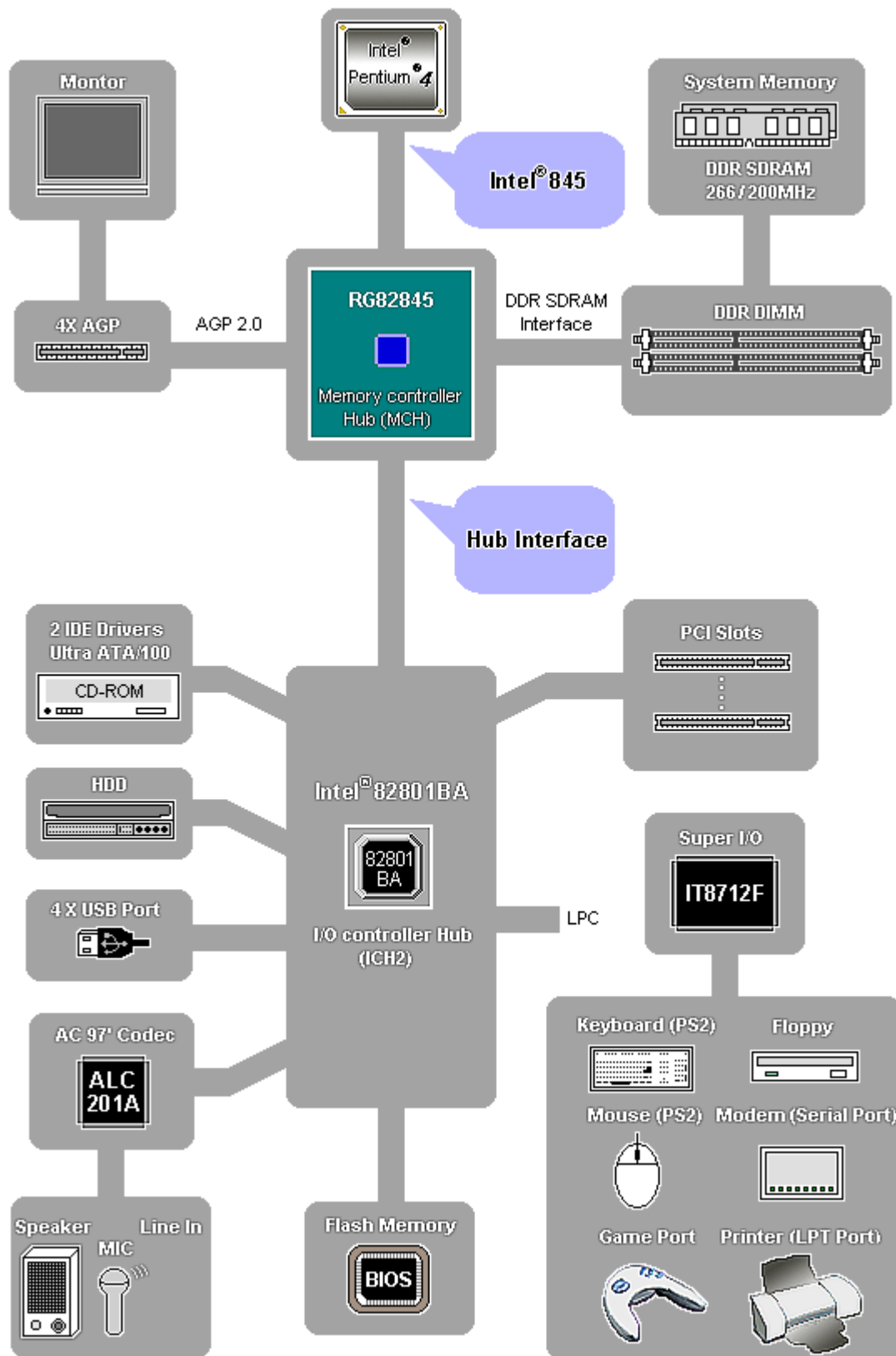

INTRODUCTION

1.3 Specification

Processor	Supports Intel Pentium® 4 Northwood CPU with 400Mhz FSB frequency Supports 478 FCPGA2 pin-package Pentium® 4
Chipset	Intel RG82845 SL5YQ and memory controller Hub (MCH) Intel FW82801BA I/O Controller Hub (ICH2)
BIOS	Award® PCI BIOS, support ACPI, DMI, Plug-and-Play, Boot from CD-ROM, SCSI, LS-120, and ZIP devices, Anti-virus BIOS to prevent boot virus
System Memory	2 x 184 pin DDR DIMMs to support up to 2GB DDR SDRAM ECC DIMM support
On-board I/O Features	1 x Floppy Port (Up to 2.88MB) 1 x Parallel Port (Support EPP and ECP) 2 x Serial Ports (16550 Fast UART Compatible) 2 x USB Ports 2 x USB Header (for 2 additional USB ports on front/side panel) 1 x MIDI/game port 1 x Audio jacks: Line-out, Line-in and MIC-In 2 x Ir DA TX/RX Header
Advanced Features	Supports AGP 2.0 including 4x AGP (only) data transfer and 4x Fast AC97 Audio on board Suspend to RAM support CNR for MC97 modem upgrade Modem Ring-in Remote Power on Wake up on LAN Keyboard Power On Hardware Monitoring function
Master IDE	2 x UltraDMA/100 IDE Ports support up to 100 MB/Sec.
Expansion Slots	ONE CNR SLOT, 32-bit AGP slot, Five 32-bit PCI Bus Master slots
ATX Power Connector	3V, 5V and 12V 20-Pin ATX Power connector
I/O Controller	ITE IT8712F Low Pin Count (LPC) interface

INTRODUCTION

1.4 Board Level Feature

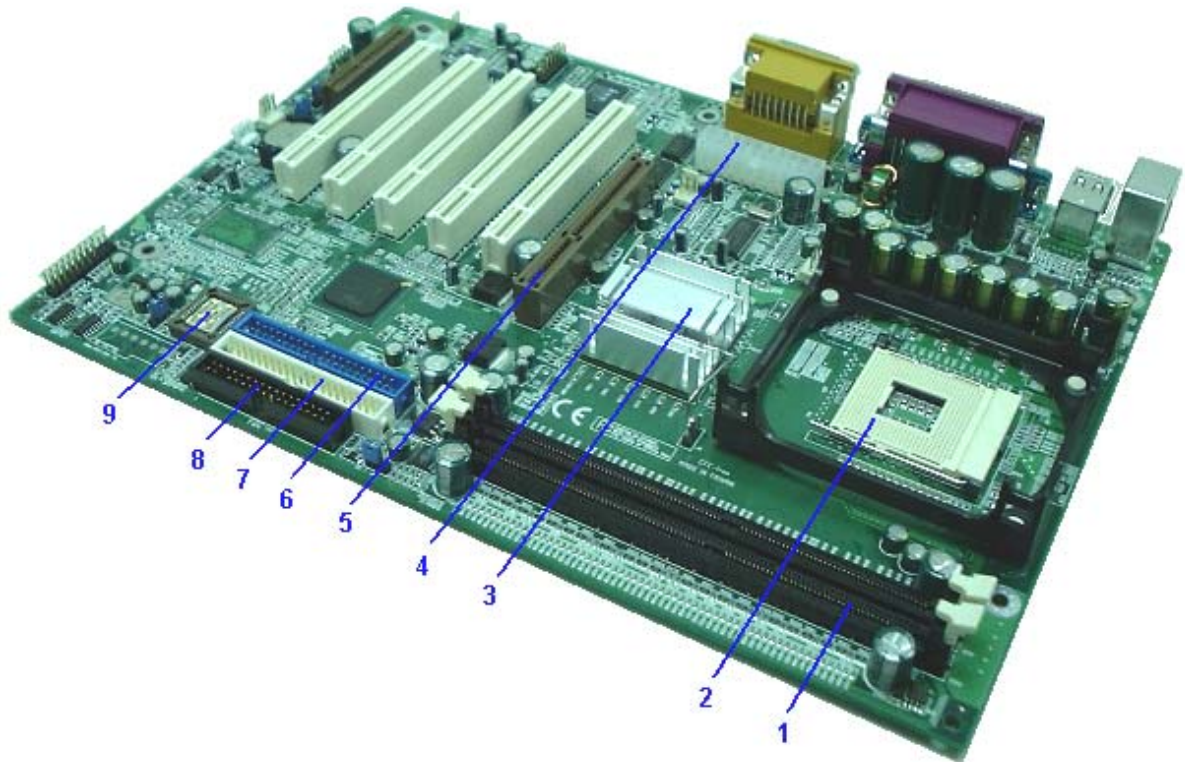

1. **DDR DIMM Sockets:** Two 184-pin DIMM Sockets support up to 2GB.
2. **CPU Socket:** ZIF Socket 478 for Intel Pentium 4 (Northwood) CPU.
3. **North bridge controller:** Intel RG82845 and memory controller Hub.
4. **ATX power connector:** 20-Pin ATX Power Connector.
5. **AGP Slot:** Accelerated Graphics Port (AGP).
6. **IDE1 connector:** Connector for first IDE channel.
7. **IDE2 connector:** Connector for second IDE channel.
8. **Floppy disk connector:** Built-in Floppy controller supports (2) 5.25" or 3.5" Floppy drives.
9. **BIOS:** Award Plug & Play Bios.

INTRODUCTION

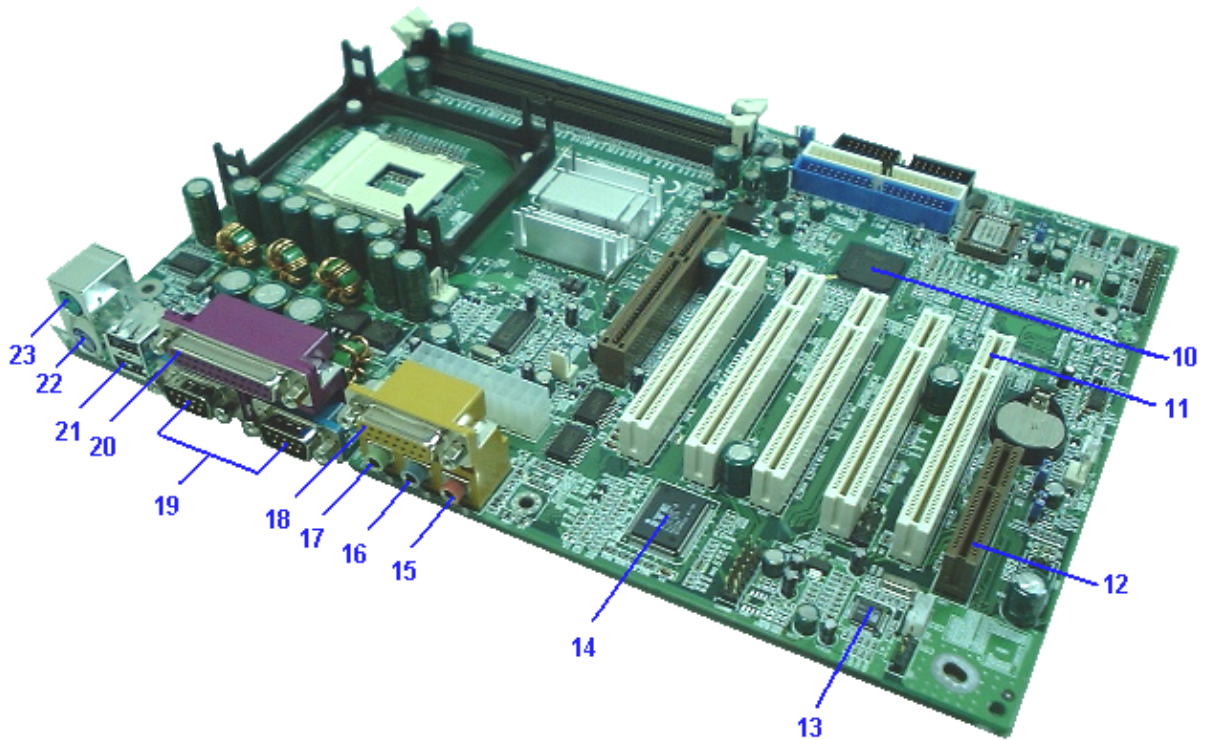

10. South bridge controller: Intel FW82801BA I/O Controller Hub (ICH2).

11. PCI Slots: Five 32-bit PCI Slots are provided.

12. CNR Slot: Communication and Networking Riser (CNR) Connector.

13. Audio CODEC: Three 1/8 female jacks for Line Out, Line In and MIC

14. Super I/O: ITE8712F.

15. Microphone jack: This MIC (pink) jack connects a microphone.

16. Line in jack: This Line In (light blue) jack connects a tape player or other audio sources.

17. Line Out jack: This Line Out (lime) jack connects a headphone or a speaker.

18. MIDI/Game Port: 15-pin female MIDI/Joystick connector.

19. Serial Port: Two 9-pin COM1/COM2 ports.

20. Parallel Port: EPP and ECP compatible 25-pin D-Sub parallel port.

21. USB Ports: Two 4-pin USB Connectors.

22. PS/2 Keyboard Port: Supports PS/2 style keyboards.

23. PS/2 Mouse Port: Supports PS/2 style mice.

INTRODUCTION

1.5 Comprehensive Mainboard View

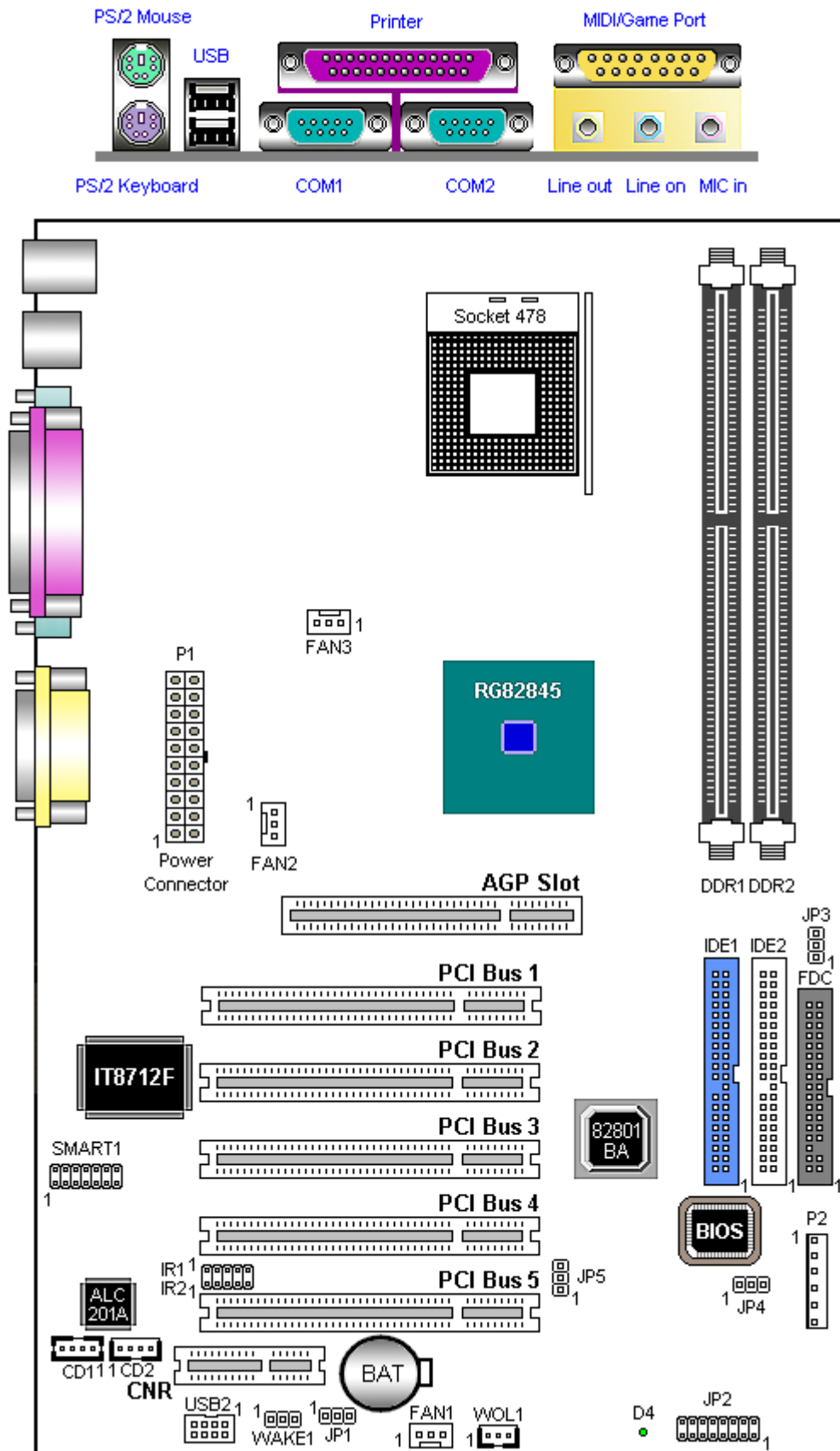

HAREWARE INSTALLATION

2. Hardware Installing

2.1 Jumpers Setting

Static Precautions

Static electricity can be a serious danger to the electronic components on This mainboard. To avoid damage caused by electrostatic discharge, observe the following precautions:

- Don't remove the mainboard from its anti-static packaging until you are ready to install it into a computer case. Also, handle add-in cards and modules by the edges or mounting bracket.

- Before you handle the mainboard in any way, touch a grounded, anti-static surface, such as an unpainted portion of the system chassis, for a few seconds to discharge any built-up static electricity.

2.1.1 Setting the Jumpers

Jumpers are used on this mainboard to select various settings and features. A 2-pin jumper has two settings: Open and Short (or Closed). The jumper is closed by placing the Jumper Cap across the two pins, thereby connecting them. 3-pin jumpers can be set to pins 1-2 or 2-3 connected. Pin-1 is labeled on the circuit board.

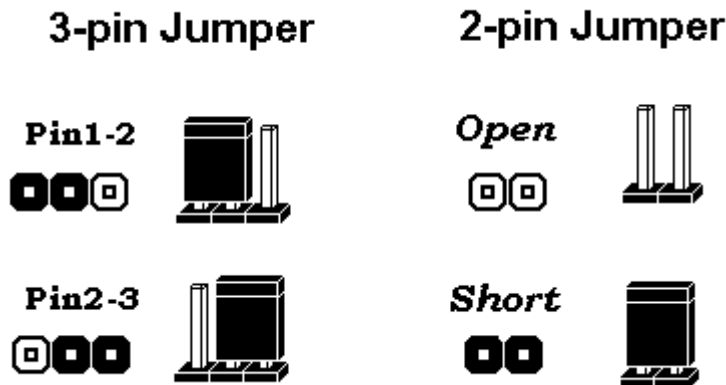

HAREWARE INSTALLATION

2.1.2 Clear CMOS (JP3)

If you have set the password, either to protect the BIOS configuration or to restrict access to the computer, the password is stored in CMOS RAM. If you forget the password, the CMOS can be cleared by setting this jumper to Clear CMOS. Also in case there is a CMOS error or improper CPU setting through the mainboard's BIOS that causes boot failure, the CMOS must be cleared by setting this jumper to Clear CMOS to allow the system to boot.

Clearing the CMOS will clear all user-defined BIOS setup options.

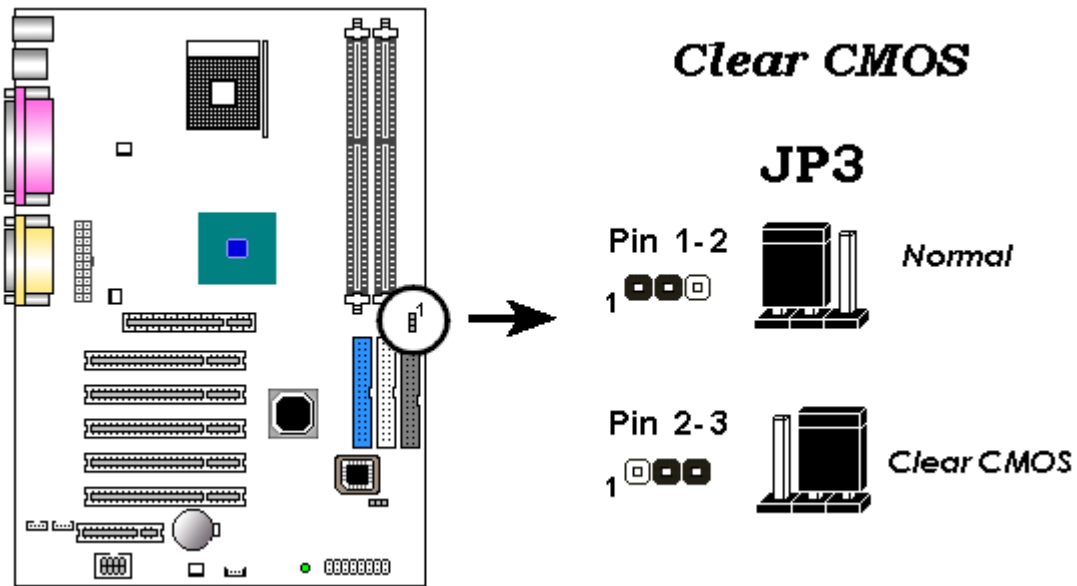

2.1.3 Flash BIOS Write Protect/Enable (JP4)

To re-program the mainboard BIOS, short this jumper to enable writing to the flash BIOS.

Set to Write Protect to prevent writing to the flash BIOS.

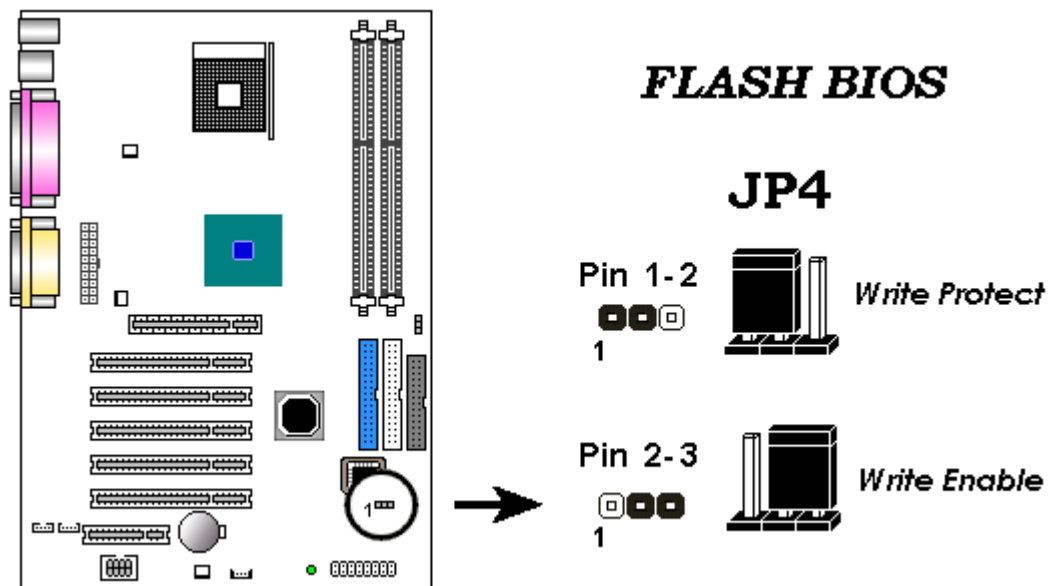

HAREWARE INSTALLATION

2.1.4 Smart Card Reader connector

This connector accommodates a Smart Card Reader that allows you to conveniently make transactions such as financial, health care, telephony, or traveling services through a Smart Card user interface software.

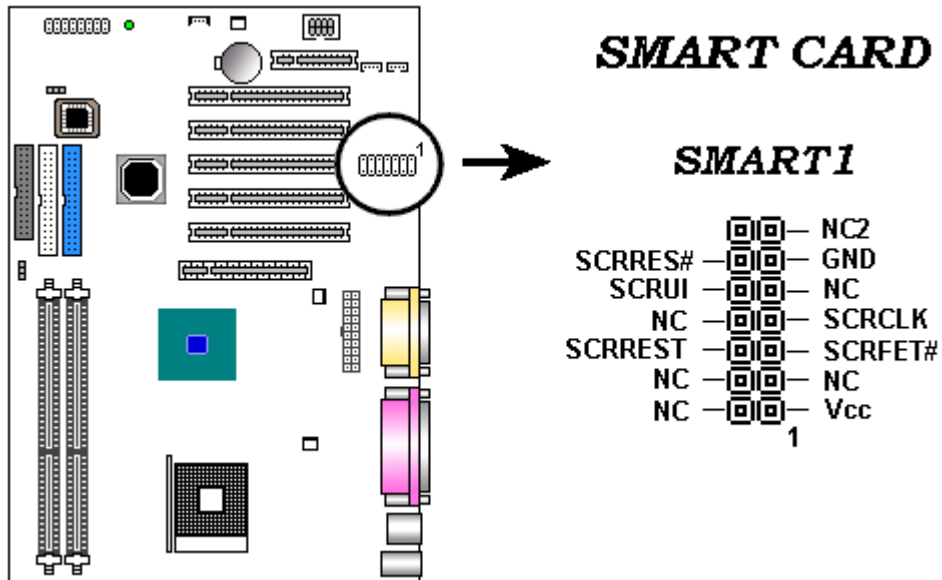

HAREWARE INSTALLATION

2.2 Connections

2.2.1 Installing the CPU

- > **WARNING:** Use of a CPU Cooling Fan is required to prevent CPU from overheating.
The Fan should be installed first before inserting the CPU into its socket.
- > Locate the ZIF(Zero Insertion Force) Socket 478.

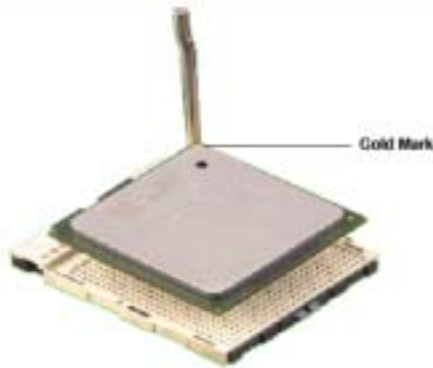

- > First open the socket by pulling the lever sideways, then upwards. Notice how the lever locks in place when pressed all the way down.
- > The CPU must be inserted with the correct orientation. One corner of the CPU has a Notch and looks different that the other three. This corner is also missing a pin unlike the other three.
Align this corner towards the end of the lever as shown in the figure at right. Insert the CPU , press it down.
- > Close the lever until it locks into place.



HAREWARE INSTALLATION

2.2.2 Installing the Heatsink and Fan

The Intel® Pentium® 4 478/Northwood Processor requires a specially designed Heatsink and fan assembly to ensure optimum thermal condition and performance.

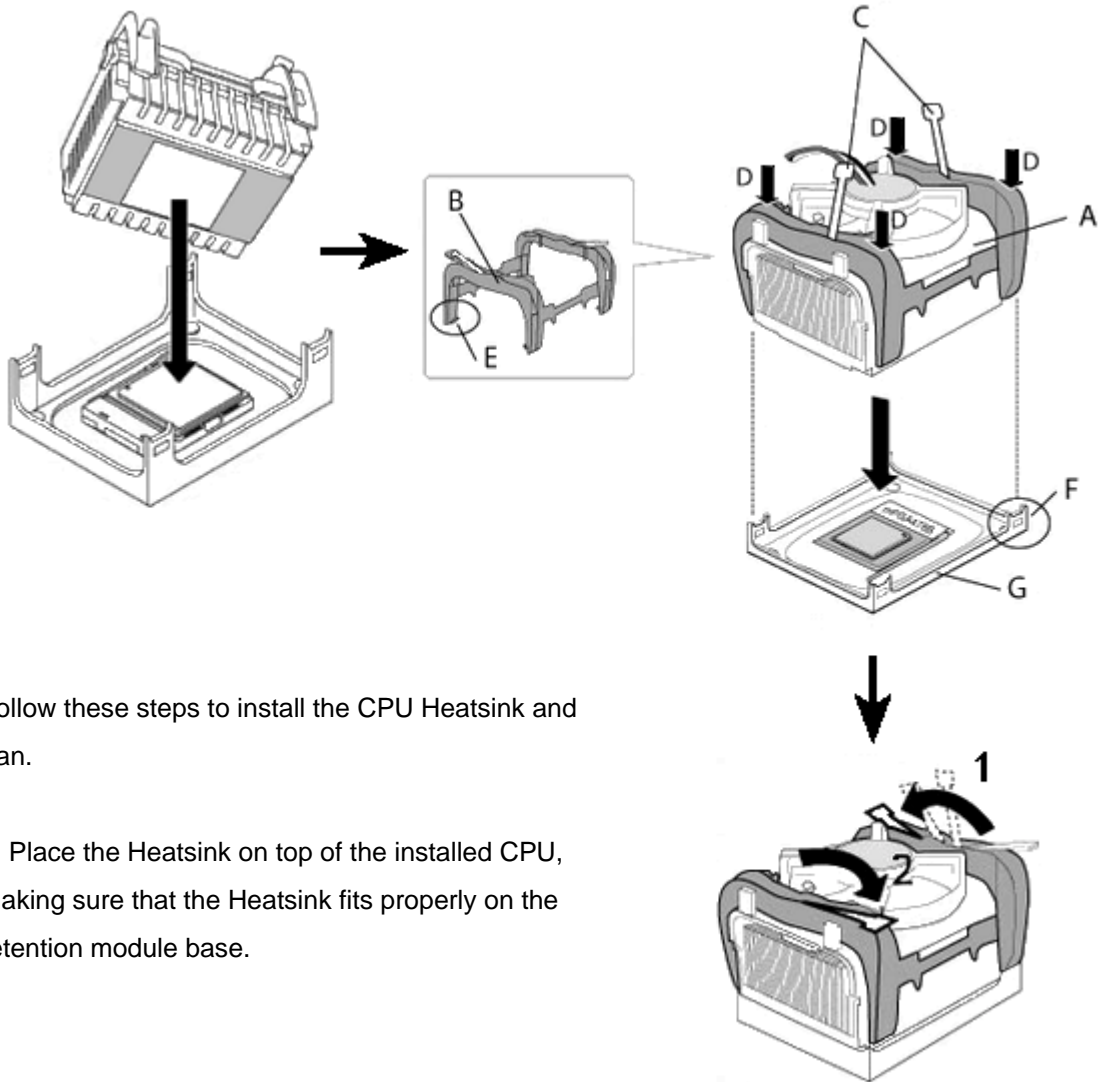

Follow these steps to install the CPU Heatsink and Fan.

1. Place the Heatsink on top of the installed CPU, making sure that the Heatsink fits properly on the retention module base.

2. Position the fan with the retention mechanism on top of the Heatsink. Align and snap the four hooks of the retention mechanism to the holes on each corner of the module base.

3. Push down the locks on the retention mechanism to secure the Heatsink and fan to the module base.

HAREWARE INSTALLATION

2.2.3 Cooling Fan

The three fan connectors support cooling fans of 350mA (4.2 Watts) or a total of 1A (12W) at +12V. Orient the fans so that the hear sink fins allow air flow to go across the onboard heat sinks instead of the expansion Slots. The fan wiring and plug may vary depending on the fan manufacturer. Connect the fan cable to the connector matching the black wire to the ground pin. These are small 3-pin Header Connectors that provide 12-Volt power for CPU and chassis cooling fans. Plug in the fan cable to the connector. Pin-2 corresponds to the RED power lead as shown:

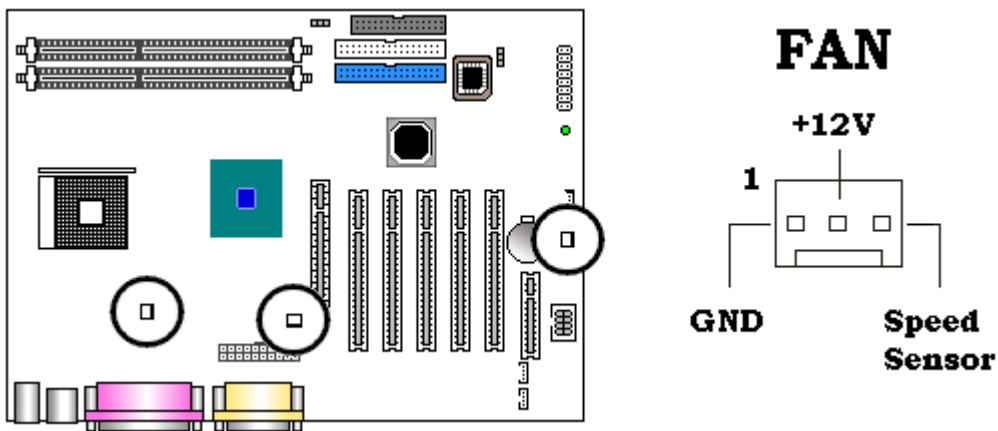

HAREWARE INSTALLATION

2.2.4 Installing the Memory Modules (DIMM)

■ This mainboard has three sockets available for **184-pin DIMMs**. They must be 3.3 volt Un buffered Synchronous DDR RAMs (DDR RAM).

■ DIMM Sizes supported:**128MB, 256MB, 512MB.**

■ A total of 2 DIMMs can be installed for a maximum RAM capacity of **2GB.**

To insert the DIMMs, the modules must be oriented in the correct way. Notice the notches of the DIMM. Align these notches as shown in the diagram below. Gently push the DIMM until the retainers on both sides of the socket lock the module in place. To remove a DIMM, push the retainers outwards to release the module then pull the module out of the socket.

Total Memory Sizes With Unbuffered DDR DIMM

Devices used DIMM	1DIMM x64 / x 72	2DIMMs x64/ x 72
64Mbit (2Mx8x4 banks)	128 Mbytes	256 Mbytes
64Mbit (1Mx16x4 banks)	32Mbytes	64 Mbytes
128Mbit (4Mx8x4 banks)	256Mbytes	512 Mbytes
128Mbit (2Mx16x4 banks)	64Mbytes	128Mbytes
256Mbit (8Mx8x4 banks)	512Mbytes	1GBytes
256Mbit (4Mx16x4 banks)	128Mbytes	256 Mbytes
512Mbit (16Mx8x4 banks)	1Gbytes	2GBytes
512Mbit (8Mx16x4 banks)	256 Mbytes	512 Mbytes

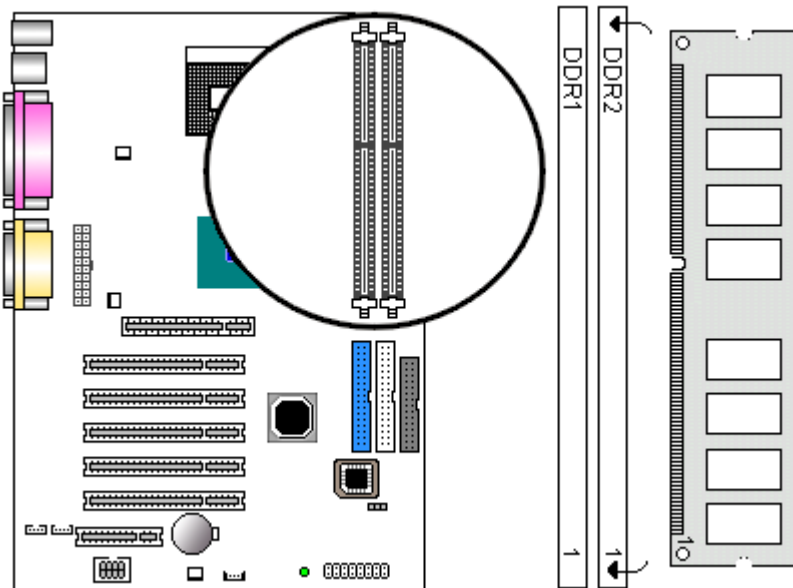

- 1.TheDIMM Slot has a notch, so the DIMM memory module can only fit in one direction.
- 2.Insert the DIMM memory module vertically into the DIMM Slot. Then push it down.
- 3.Close the plastic clip at both edges of the DIMM Slots to lock the DIMM module.

HAREWARE INSTALLATION

2.2.5 Floppy Drives

This connector supports the provided floppy drive ribbon cable. After Connecting one end to the mainboard, connect the other end to the Floppy drive. (Pin 5 is removed to prevent incorrect insertion when Using ribbon cables with pin 5 plug).

Note: Make sure the RED stripe on the ribbon cable is oriented towards Pin-1.

2.2.6 IDE Hard Drives and CD-ROMs

This connector support the provided UltraDMA/100/66 IDE hard disk Ribbon cable. Connect the cable's blue connector to the primary (recommended) or secondary IDE connector, then connect the gray connector to the UltraDMA/100/66 slave device (hard disk drive) and the black connector to the ltraDMA/100/66 master device. It is recommended that you connect non-UltraDMA/100/66 devices to the secondary IDE connector. If you install two hard disks, you must configure the second drive as a slave device by setting its jumper accordingly. Refer to the hard disk documentation for the jumper settings. BIOS supports specific device boot up. If you have more than two UltraDMA/100/66 devices, purchase another UltraDMA/100/66 cable. You may configure two hard disks to be both master devices with two ribbon cables – one for the primary IDE connector and another for the secondary IDE connector.

Note: Make sure to align the RED stripe on the ribbon cable with Pin-1 on the mainboard IDE connector. On most hard drives and CD-ROMs, the RED stripe should be oriented towards the power connector of the device

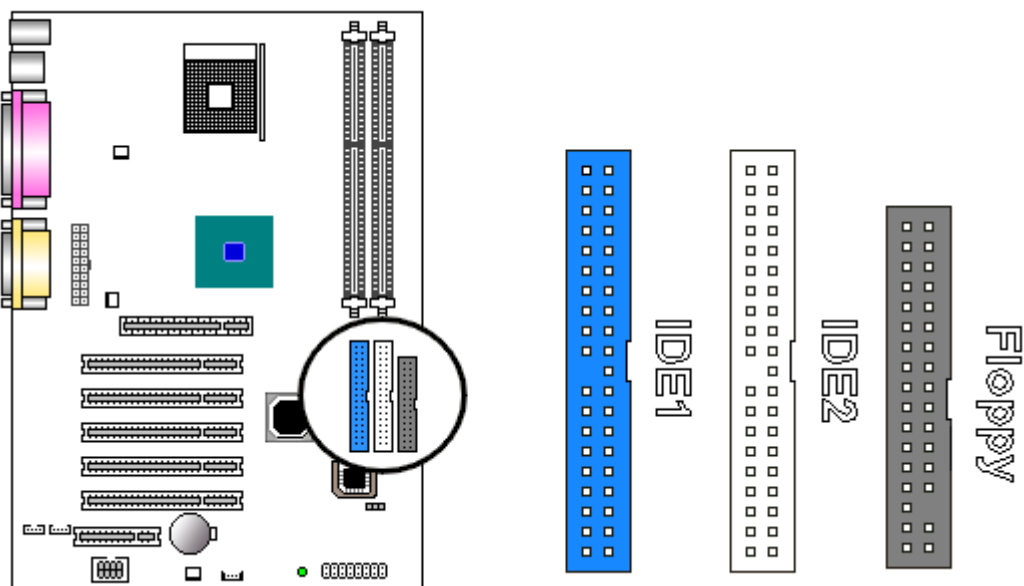

HAREWARE INSTALLATION

2.2.7 Power LED Connections

System Function Connector Block (J6)

- ☆ Pins [2 & 4 & 6] Power LED lead

Pins 2 & 4 & 6 connect to the power LED from the system's case.

- ☆ Pins [3 & 4 & 5 & 6] Speaker

Connects to the Speaker lead from the systems case.

- ☆ Pins [8 & 10] Suspend LED lead

This LED blinks to indicate the system is in suspend mode.

- ☆ Pins [11 & 12] IDE Activity LED

Hook the IDELED lead to this connector, with the RED lead corresponding to Pin-1.

- ☆ Pins [13 & 14] Reset switch lead

Connects to the Reset Switch lead from the system's case. The reset switch is used to cold-boot t the system without actually turning off the power, reducing wear and tear on the power supply.

- ☆ Pins [15 & 16] Soft Power Switch

Connects to the Power Switch featured on ATX case designs. This switch must be hooked up before the system can be powered on.

Note: Under the following two conditions, you have to press and hold the switch for longer than 4 seconds to power off your system, regardless of the Soft-Off by PWRBTN setting in the BIOS.

- Shortly after the system is powered on, when the BIOS message is not yet appear.
- When CPU hangs.

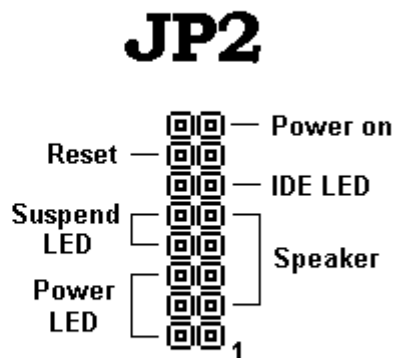
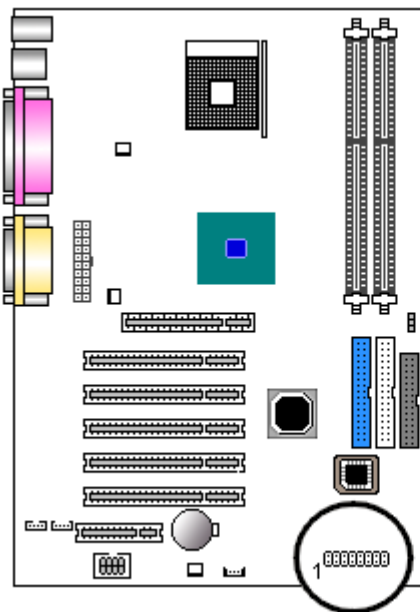

HAREWARE INSTALLATION

2.2.8 Power Supply Connector

The ATX-style Power Supply Connector is keyed to prevent connection in the wrong direction. Line up the locking mechanism on the connector from the Power Supply with the tab on the mainboard connector. Press down until the two connectors are locked.

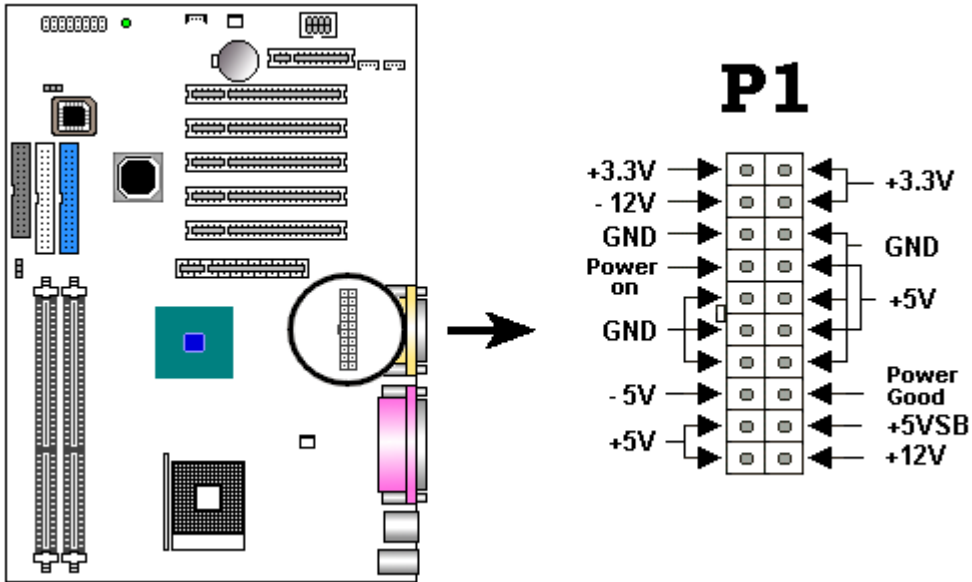

2.2.9 IrDA-Compliant Infrared Module Connector (IR1)

The IrDA connector bracket hooks directly to this connector on the mainboard. This connector provides support for the optional wireless transmitting and receiving infrared module. You must first configure through the BIOS setup where UART2 is directed, COM2 or IrDA.

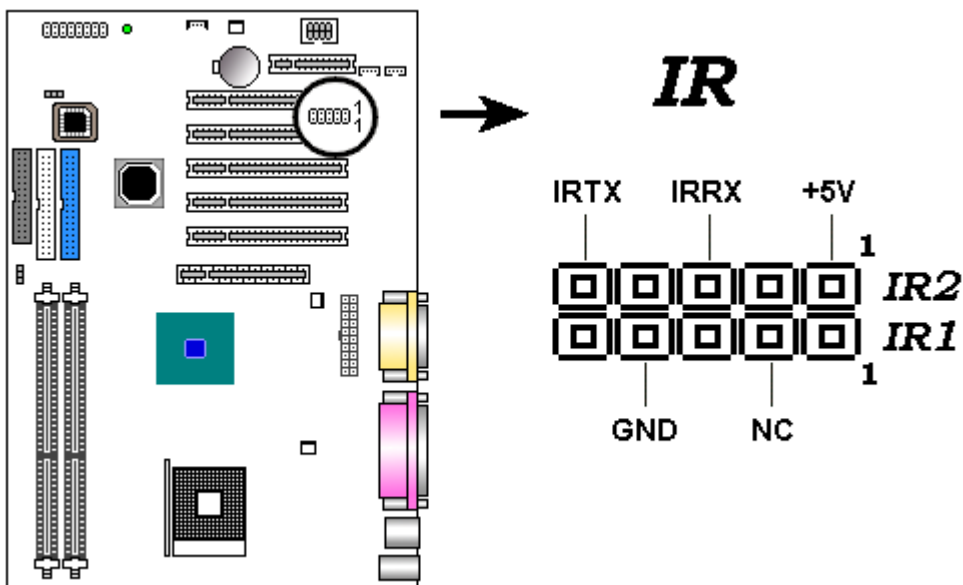

HAREWARE INSTALLATION

2.2.10 LAN Wake-up Connector (Lan1)

The LAN Wake-up function will allow the network to wake up a Soft Power Down (Soft-Off) PC. However, if your system is in the Suspend mode, you can wake-up the system only through an IRQ or DMA interrupt. To use the LAN Wake-up function, you must enable the **Wake Up On LAN/Ring** field (under **Wake Up Events**) in the **Power Management Setup** of the Award BIOS. Connect the cable that comes with your LAN card to this connector on the system board. Refer to the add-in card's manual for details.

Note: Your LAN card must support Magic Packet in order to use the LAN Wake-up function.

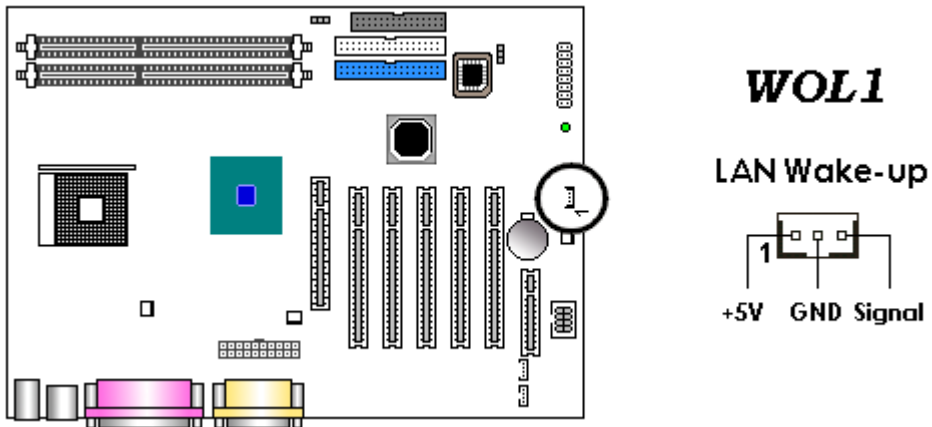

2.2.11 External Connectors

☆ MIDI/Game Port (Optional)

You may plug a joystick or game pad to this (Gold color) 15-pin female connector for game playing, or connect a MIDI device for playing or editing audio.

☆ Audio Port (Optional)

You can connect powered speakers or headphones to (Lime color) Line Out jack. Cassette players or other external audio sources can be connected to (Light Blue color) Line In jack. Plug in your microphones to (Pink color) MIC jack.

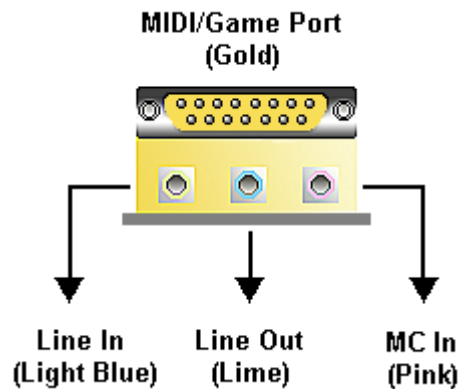

HAREWARE INSTALLATION

☆ Audio Connectors (CD1,CD2)

This CD Audio connector is available for connecting the CD-ROM drive using CD audio cable.

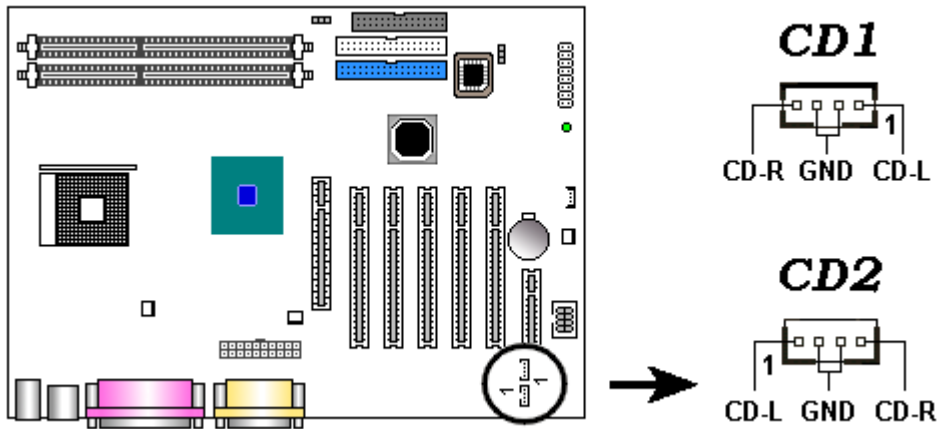

☆ Serial and Parallel Ports

A (Burgundy color) 25-pin D-Sub header is provided on the back panel for a multi-mode bi-directional parallel port. Two (Teal/Turquoise color) 9-pin D-Sub headers are also provided on the back panel for Serial ports.

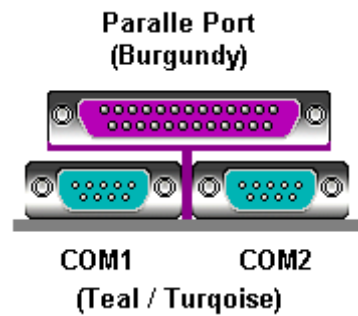

Pin Definition

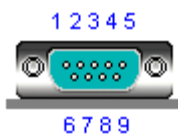

PIN	SIGNAL	DESCRIPTION
1	DCD	Data Carry Detect
2	SIN	Serial In or Receive Data
3	SOUT	Serial Out or Transmit Data
4	DTR	Data Terminal Ready)
5	GND	Ground
6	DSR	Data Set Ready
7	RTS	Request To Send
8	CTS	Clear To Send
9	RI	Ring Indicate

HAREWARE INSTALLATION

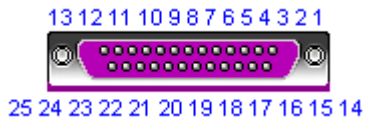

12	PE	Paper End
13	SELECT	Select
14	AUTO FEED#	Automatic Feed
15	ERR#	Error
16	INIT#	Initialize Printer
17	SLIN#	Select In
18	GND	Ground
19	GND	Ground
20	GND	Ground
21	GND	Ground
22	GND	Ground
23	GND	Ground
24	GND	Ground
25	GND	Ground

Pin Definition

PIN	SIGNAL	DESCRIPTION
1	STROBE	Strobe
2	DATA0	Data0
3	DATA1	Data1
4	DATA2	Data2
5	DATA3	Data3
6	DATA4	Data4
7	DATA5	Data5
8	DATA6	Data6
9	DATA7	Data7
10	ACK#	Acknowledge
11	BUSY	Busy

☆ PS/2 Keyboard and Mouse Connectors

These two connectors (Green color) PS/2 Mouse and (Purple color) PS/2 Keyboard are located on the back panel of the mainboard.

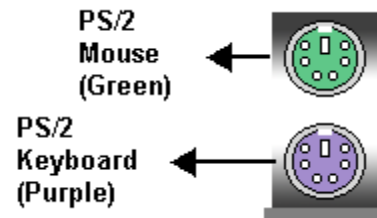

Pin Definition

PIN	SIGNAL	DESCRIPTION
1	Keyboard DATA	Keyboard DATA
2	NC	Noconnection
3	GND	Ground
4	Vcc	+5V
5	Keyboard Clock	Keyboard clock
6	NC	No connection

HAREWARE INSTALLATION

☆ USB Connectors

This mainboard supports (Black color) 4 USB devices. If the USB port connectors on the rear panel are inadequate, three USB headers are available for additional USB port connectors. The header labeled USB complies with the Universal Serial Bus (USB) 1.1 specification. Connect the bundled 2-port USB connector set to this header and mount the USB bracket to an open Slot in the chassis. The other two USB headers comply with USB 2.0 specification that supports up to 480 Mbps connection speed. This speed advantage over the conventional 12 Mbps on USB 1.1 allows faster Internet connection, interactive gaming, and simultaneous running of high-speed peripherals. These headers support the next generation USB peripherals such as high resolution cameras, scanners, and printers.

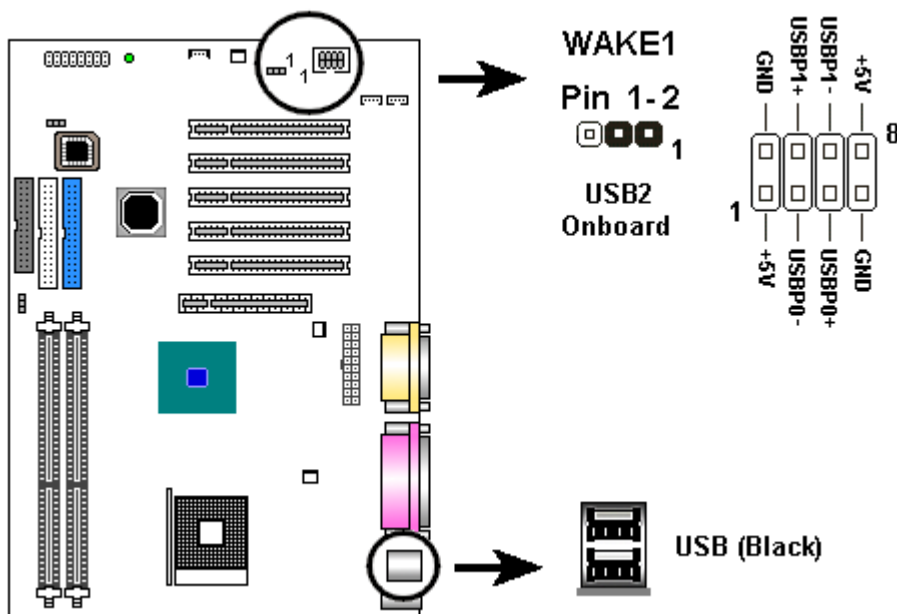

The Cable from the USB connector bracket hooks to the USB header on the mainboard.

These two connectors permit connection of two USB peripheral devices directly to the system.

USB Port Description



PIN	SIGNAL	DESCRIPTION
1	Vcc	+5V
2	-Data 0	Negative Data Channel 0
3	+Data 0	Positive Data Channel 0
4	GND	Ground
5	Vcc	+5V
6	-Data 1	Negative Data Channel 1
7	+Data 1	Positive Data Channel 1
8	GND	Ground

HAREWARE INSTALLATION

2.2.12 Installing an AGP Card

The main board provides an AGP slot to support 4X AGP set with model shipped with the package. This mainboard has Accelerated Graphics Port (AGP) Slot that Support +1.5V cards. When you buy an AGP card, make sure that you ask for one with +1.5V specification. Note the notches on the card Golden fingers to ensure that they fit the AGP slot on your mainboard.

Note:

The main board with Intel AGP set (North Bridge) RG828845 is support up to 4X AGP set.

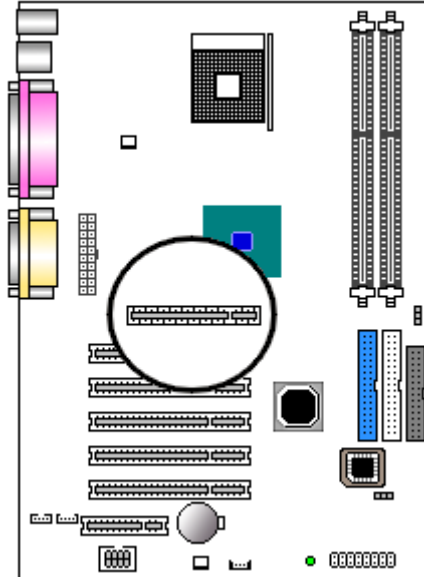

2.2.13 Installing a PCI Card

There are 32-bit PCI Slots in this mainboard. The Slots support PCI cards such as a LAN card, Sound card, USB card, and other cards that comply with PCI specifications.

The following figure shows a LAN card installed on a PCI Slot.

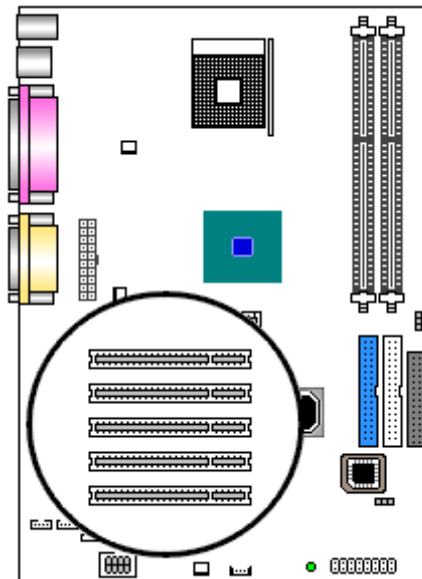

HAREWARE INSTALLATION

2.2.14 Installing an CNR Card

One CNR (Communication and Networking Riser) standard interface connector is supports Audio CODEC 97 (AC97) and/or Modem Codec97 (MC97) cards. This provides an upgradeable audio and/or modem solution at an incredibly low cost. There are two type of CNR, one defined as primary and another defined as secondary. This main board uses as primary channel so, a secondary CNR can co exist without the need to disable the onboard CODEC. The main board's onboard CODEC must be disable when using the primary CNR.

Note:

If your audio function is coming from the CNR card instead of the onboard audio feature, set AC97/MC97 Mode jumper block properly (Refer to page 13). Also make sure the **AC97 Audio** option is set to *Auto* (default) in **Advanced Chipset Features** of the BIOS.

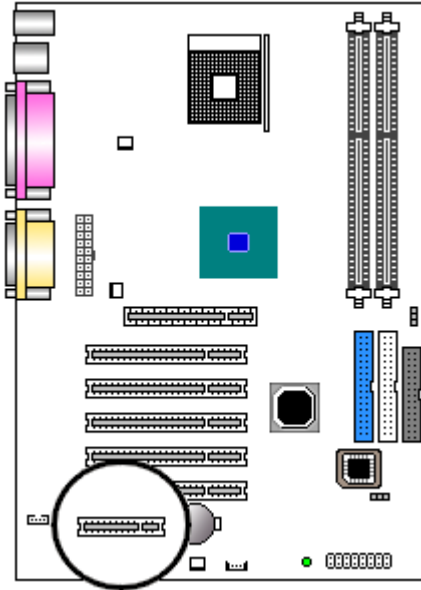

2.2.15 Onboard LED

When lit , the onboard LED indicates hat the system is ON , in sleep mode or in soft-off mode , not powered OFF , See the illustration bellow.

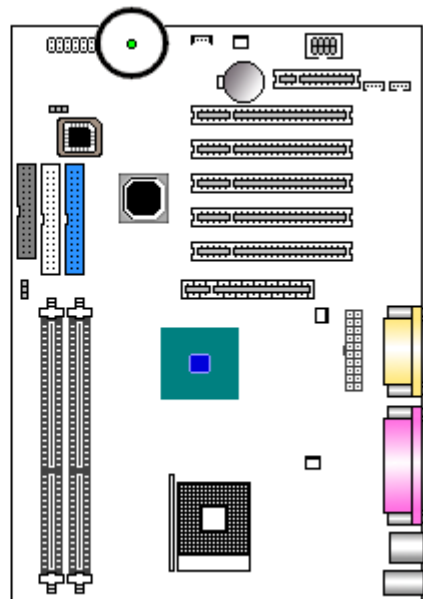
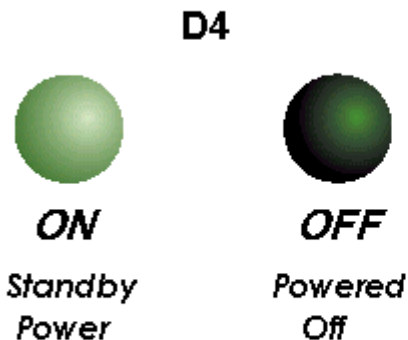

MAINBOARD BIOS SETUP

3. MAINBOARD BIOS SETUP

3.1 About the BIOS

The Mainboard BIOS (Basic Input/Output System) acts as the bridge between your Hardware (CPU, Disk Drives, Video, etc.) and Operating System Software (Windows 95, OS/2 and so on) The BIOS Setup (also called CMOS Setup) is where many hardware configuration options are set and stored. This configuration information will remain in the BIOS until it is changed, or cleared by removing the battery for a while then reinstalling it back or by setting the Clear CMOS jumper if there is one.

CMOS (Complementary Metal Oxide Semiconductor) refers to the chip in which the BIOS information is stored. This mainboard features Award BIOS, which provides an easy to use Setup program to aid in hardware configuration. In this section we will look at the various menus and options contained in the Award BIOS Setup Program. This mainboard also features a Flash BIOS. A Flash BIOS can be upgraded via software, thereby eliminating the need to actually replace the BIOS Chip on the mainboard. Procedures for updating the BIOS follow this section. The Award BIOS installed in your computer system's ROM (Read Only Memory) is a custom version of an industry standard BIOS. This means that it supports Intel processor in a standard IBM-AT compatible input/output system.

☆ Using Setup

In general, you use the arrow keys to highlight items, <Enter> to select or display the possible selections, <Page Up> and <Page Down> keys to change entries, <F1> for general help and <Esc> to quit.

An item marked with a indicates that there is a submenu for this item. A gray-out item marked with an x indicates that the item is not available. The item may be associated with another item and its availability is dependent on that associated item. Gray-out items are for information display only and contain no selectable fields.

MAINBOARD BIOS SETUP

☆ Getting Help

Pressing <F1> will display a help window that describes the appropriate keys to use. Pressing <Enter> will display a small help window that describes the possible selections for the highlighted item. To exit the Help Window press<Esc>.

A brief description of some highlighted selection may appear at the right frame (titled Item Help) of the setup screen.

☆ A Final Note about Setup

Not all systems have the same Setup. While the basic look and function of the Setup program remains the same for all systems, individual motherboard and chipset combinations require custom configurations. For example, you may find that your Setup main menu has a different number of entries from the main menu displayed in this manual. These are simply features not supported (or not user configurable) on your system. The final appearance of the Setup program also depends on the Original Equipment Manufacturer (OEM) who built your system. If your OEM has decided that certain items should only be available to their technicians, those items may very well be removed from the Setup program.

MAINBOARD BIOS SETUP

3.2 Main Menu

Shortly after the system is powered on, provided a CPU and sufficient RAM are installed, you will see the message:

Press DEL to enter SETUP

- Press the **DEL** key to enter the Award BIOS Setup program.

Once you enter the Award BIOS CMOS Setup Utility, the Main Menu will appear on the screen. The Main Menu allows you to select from several setup functions and two exit choices. Use the arrow keys to select among the items and press <Enter> to accept and enter the sub-menu.

CMOS Setup Utility Main Screen

CMOS Setup Utility - Copyright (C) 1984 - 1999 Award Software

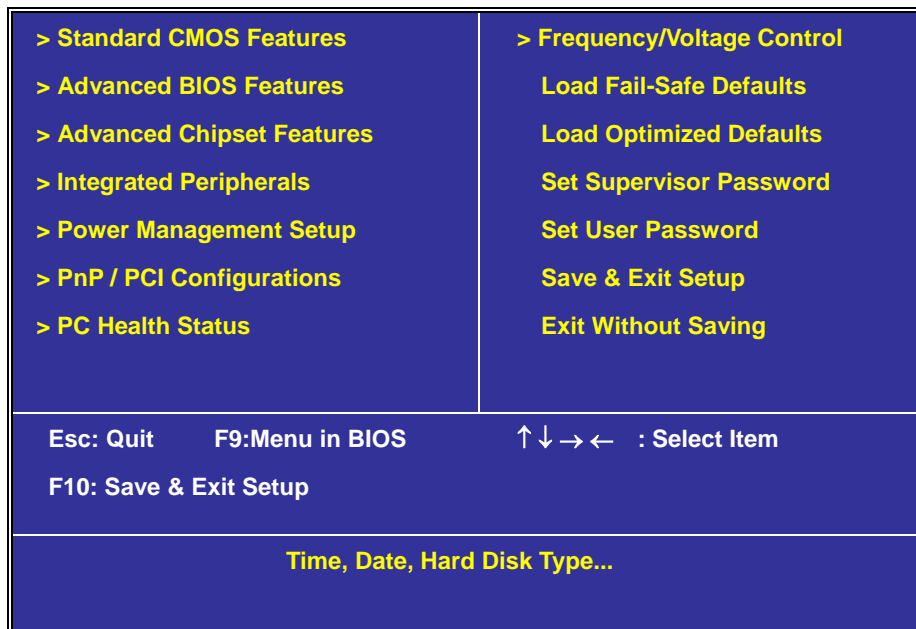

Note that a brief description of each highlighted selection appears at the bottom of the screen.

MAINBOARD BIOS SETUP

3.3 Standard CMOS Features

This first menu is where the most basic hardware options are set. Information regarding the system clock, IDE hard disks and floppy drives is stored and configured in this section.

To enter the Standard CMOS Features setup screen, press the [ENTER] key with this menu highlighted. Upon entering the Standard CMOS Setup screen, you will see a screen like that below:

Standard CMOS Features Screen
CMOS Setup Utility - Copyright (C) 1984 - 1999 Award Software
Standard CMOS Features

Date (mm : dd : yy)	Fri, Jan 1 1999	Item Help
Time (hh : mm : ss)	1 : 28 : 42	Menu Level >
>IDE Primary Master	Press Enter 4403 MB	
>IDE Primary Slave	Press Enter None	
>IDE Secondary Master	Press Enter None	
>IDE Secondary Slave	Press Enter None	
Drive A	1.44M, 3.5 in.	
Drive B	None	
Floppy 3 Mode Support	Disabled	
Video	EGA/VGA	
Halt On	All Errors	
Base Memory	640K	
Extended Memory	14336K	
Total Memory	15360K	

↑ ↓ → ←: Move Enter: Select +/-/PU/PD: Value F10: Save ESC: Exit
F1: General Help F5: Previous Value F6: Fail-Safe Defaults F7: Optimized Defaults

☆ Date and Time

Use the arrow keys to move to and highlight the Date option. Select the Month by using the <Page Down> and <Page Up> keys. This is how most settings will be configured. Then, move to the day, year and time via the arrow keys to finish setting the system date and time.

MAINBOARD BIOS SETUP

IDE Primary Master, IDE Primary Slave, IDE Secondary Master, IDE Secondary

CMOS Setup Utility - Copyright (C) 1984 - 1999 Award Software

IDE Primary Master

IDE HDD Auto-Detection	Press Enter	Item Help
IDE Primary Master	Auto	Menu Level >
Access Mode	Auto	To auto-detect the
Capacity	4303 MB	HDD's size, head... on This channel
Cylinder	8894	
Head	15	
Precomp	0	
Landing Zone	8893	
Sector	63	

↑ ↓ → ← : Move Enter : Select + / - / P U / P D : Value F10 : Save ESC : Exit

F1 : General Help F5 : Previous Value F6 : Fail-Safe Defaults F7 : Optimized Defaults

☆ Slave

These four options relate to the (4) IDE hard drives, CD-ROMs or other ATAPI devices that can be controlled via the on-board IDE controller (review IDE Hard Drives and CD-ROMs in the Installation Guide). The IDE Primary Master setting specifies the first device on the primary IDE channel, IDE Primary Slave - the second. IDE Secondary Master and IDE Secondary Slave specify the devices on the secondary channel.

Pressing <Enter> at each of the four selections brings up a submenu such as one shown below:

☆ IDE HDD Auto-Detection

Automatically detects and configures hard disk parameters. The Award BIOS includes this ability in the event you are uncertain of your hard disk's parameters.

MAINBOARD BIOS SETUP

☆ IDE Primary/Secondary Master/Slave

This is where you will specify the type of device and how it is represented in the BIOS Setup. If the device is a hard disk or CD-ROM, generally the **Auto** option is the best choice for fast and easy setup of the hard disk parameters. Let's take a look at the difference between the *Auto* and *Manual* options:

▶▶ Auto

This option instructs the BIOS to automatically configure the hard disk by reading the parameters (cylinders, sectors, etc.) directly from the hard disk's firmware. Use this option if you are configuring a new hard drive, or one that has already been formatted using the *Auto* option. Keep in mind that a hard drive is configured using a certain set of parameters, those same parameters must be used for the life of the drive, unless the drive is re-FDISKed using a different parameter set. (This procedure deletes the old partition(s) on the drive and creates a new one, using the new parameters).

▶▶ Manual

This option allows you to manually enter in the parameters (cylinder, head, precomp, landing zone and sector) of the hard drive. Generally, this option would be used only if the hard drive has already been formatted with a certain set of parameters, and assured consistency between the old and new parameters is desired.

☆ Access Mode

- One of Enhanced IDE's most important features is **LBA** (Logical Block Addressing) Mode. This feature allows the use of larger hard drives by providing a way to bypass the cylinder limitations imposed by many Operating Systems. LBA Mode is used to extend a hard drive's useable capacity by remapping the cylinders in a way that is acceptable to these operating systems. For instance, a hard drive with the parameters of 2100 Cylinders, 16 Heads and 63 Sectors would be represented by LBA Mode as 525 Cylinders, 64 Heads and 63 Sectors. (Notice that the Cylinders have been divided, and the Heads have been multiplied, by a factor of 4.)
 - On hard drives smaller in capacity than 528MB, LBA support is not needed. The option on these devices is ignored, even if enabled. For hard drives greater than 528MB, LBA mode should be enabled. The following rules apply:
 - Operating Systems that do not use the FAT file system do not need LBA Mode, and can use the Normal or Large Modes. Examples would be NetWare and Unix.

MAINBOARD BIOS SETUP

- When configuring a new hard drive greater than 528MB in capacity, always make sure LBA mode is enabled.
- If you are using a hard drive that is over 528MB in capacity, but was already formatted without using LBA mode, LBA support will be ignored even if it is enabled. This assures correct access to the drive's data.

☆ Drive A/B

Select the Type for the A: and/or B: floppy drives. Remember, floppy drive A: is the first drive, hooked to the END of the floppy ribbon cable. Floppy drive B: is hooked up after the twist.

Available settings are listed below:

None	No floppy drive installed
360k, 5.25 in	5-1/4 inch PC-type standard drive; 360 kilobyte capacity
1.2M, 5.25 in	5-1/4 inch AT-type high-density drive; 1.2 megabyte capacity
720k, 3.5 in	3-1/2 inch double-sided drive; 720 kilobyte capacity
1.44M, 3.5 in	3-1/2 inch double-sided drive; 1.44 megabyte capacity
2.88M, 3.5 in	3-1/2 inch double-sided drive; 2.88 megabyte capacity

☆ Video

This category selects the type of video adapter used for the primary system monitor.

Although secondary monitors are supported, you do not have to select their type in Setup.

☆ Halt On

Determines whether or not the system will stop and prompt you if an error is detected during POST.

☆ Memory

This category is display-only. All memory detected by the POST (Power On Self Test) of the BIOS is shown as the following types:

☆ Base Memory

Is the amount of conventional memory installed in the system. This value is typically 640K for systems with 640K or more memory installed on the motherboard. The Extended Memory is the amount of memory located above 1MB in the CPU's memory address map. Other Memory refers to the memory located in the region between 640K and 1MB. This region can be used for shadowing as well as expanded memory in DOS.

MAINBOARD BIOS SETUP

3.4 Advanced BIOS Features

This menu provides access to more advanced BIOS configuration settings that deal with overall performance of the system and peripheral setup. This section allows you to configure your system for advanced operation. You have the opportunity to select the system's default speed, boot-up sequence, keyboard operation and security.

CMOS Setup Utility - Copyright (C) 1984 - 1999 Award Software

Advanced BIOS Features

		Item Help
Virus Warning	Disabled	
CPU L1 & L2 Cache	Enabled	Menu Level >
Quick Power On Self Test	Enabled	
First Boot Device	Floppy	
Second Boot Device	HDD-0	
Third Boot Device	LS120	
Boot other device	Enable	
Swap Floppy Drive	Disabled	
Boot Up Floppy Seek	Disabled	
Boot Up NumLock Status	On	
Gate A20 Option	Fast	
Typematic Rate Setting	Disabled	
X Typematic Rate (Chars/Sec)	6	
X Typematic Delay (Msec)	250	
Security Option	Setup	
APIC MODE	Enable	
Mps Version Control For OS	[1.4]	
OS Select For DRAM > 64MB	Non-OS2	
HDD S.M.A.R.T. Capability	Disabled	
Report No FDD For WIN 95	No	

↑ ↓ → ←: Move Enter: Select +/-/PU/PD: Value F10: Save ESC: Exit

F1: General Help F5: Previous Value F6: Fail-Safe Defaults F7: Optimized Defaults

(Scroll down to see more items, as shown here)

☆ Virus Warning

When enabled, the BIOS will monitor the boot sector and the partition table on the hard drive for any attempt to modify. If an attempt is detected, the BIOS will halt the system and prompt the warning message. Select "Disabled" if you are installing a new operating system.

MAINBOARD BIOS SETUP

☆ CPU L1 & L2 / External Cache

These options are to enable or disable CPU Internal (L1) Cache, or External(L2) Cache.

☆ Quick Power On Self Test

Select "Enabled" to speed up time required to complete Power-On Self-Test.

☆ First/Second/Third Boot Device & Boot Other Device

This option allows user to assign boot sequence of the system. Available options are Floppy, HDD, CD-ROM, SCSI, LAN, LS120 and ZIP100. Set "Boot Other Device" to Enabled if you wish to boot from another device.

☆ Swap Floppy Drive

When enabled, physical drive A will be assigned to logical drive B, and physical drive B will be assigned to logical drive A.

☆ Boot UP Floppy Seek

The system will detect and verify operation of the floppy drive type.

☆ Boot UP Numlock Status

The option allows the <NumLock> key to be activated after system boot up.

☆ Gate A20 Option

This entry allows you to select how the gate A20 is handled. The gate A20 is a device used to address memory above 1 Mbytes. Initially, the gate A20 was handled via a pin on the Keyboard (Normal). Today, while keyboards still provide this support, it is more common, and much faster, for the system chipset (Fast; default) to provide support for gate A20.

☆ Typematic Rate Setting

Select "Enabled" to configure "Typematic Rate" and "Typematic Delay" functions.

☆ Typematic Rate

Use this option to set the rate at which a character keeps repeating while you hold down a key.

MAINBOARD BIOS SETUP

☆ Typematic Delay

Select "Enabled" to set the length of delay before key strokes to repeat. Available Options are "250", "500", "750", and "1000".

☆ Security Option

You can select whether the password is required every time the system boots or only When you enter the Setup. You can assign "Supervisor Password" and "User Password" in the main CMOS Setup Utility Screen.

☆ APIC MODE

This field is used to enable or disable the APIC (Advanced Programmable Interrupt Controller). Due to compliance with PC2001 design guide, the system is able to run in APIC mode. Enabling APIC mode will expand available IRQ resources for the system. Settings: Enabled And Disabled.

☆ Mps Version Control For OS

This field allows you to select which MPS (Multi-Processor Specification) version to be used For the operating system. You need to use, consult the vendor of your operating system. Settings: 1.4 and 1.1.

☆ OS Select for DRAM > 64MB

If you are using OS/2 operating system and installed memory is larger than 64MB. You need to need have the setting in the enable mode.

☆ HDD S.M.A.R.T. Capability

The item allows you to set HDD S.M.A.R.T. (Self Monitoring Analysis Reporting Technology) Capability function. Please check with the HDD manufacturer or vendor for the S.M.A.R.T. information. Configuration options: Enabled and Disabled.

☆ Report No FDD For WIN 95

While the FDD in "STANDARD CMOS SETUP" is set to NONE, set this option to No to release IRQ6 for passing Win95 logo. This option is irrelevant under normal operation.

MAINBOARD BIOS SETUP

3.5 Advanced Chipset Features

This setup menu contains advanced configuration options relating to the mainboard chipset.

These options are rarely changed by the user.

CMOS Setup Utility - Copyright (C) 1984 - 1999 Award Software

Advanced Chipset Features

DRAM Timing Selectable	By SPD	Item Help
XCAS Latency Delay	3	Menu Level >
XActive to Precharge Delay	3	
XDRAM RAS# to CAS# Delay	3	
XDRAM RAS# Precharge	3	
DRAM Data Integrity	Non-ECC	
Memory Frequency For	Auto	
Dram Read Thermal Mgmt	Disabled	
System BIOS Cacheable	Enabled	
Video BIOS Cacheable	Disabled	
Video RAM Cacheable	Disabled	
Memory Hole At 15M-16M	Disabled	
Delay Transaction	Enabled	
Delay Prior to Thermal	64	
AGP Aperture Size(MB)	16Min	

↑↓→←: Move Enter: Select +/-/PU/PD: Value F10: Save ESC: Exit
F1: General Help F5: Previous Value F6: Fail-Safe Defaults F7: Optimized Defaults

☆ DRAM Timing Selectable

SPD Set Configure DRAM Timing Control by SPD. (Default value) Manual Set SConfigure DRAM Timing Control by Manual.

☆ CAS Latency Time

3 For Slower SDRAM DIMM module.
2 For Fastest SDRAM DIMM module. (Default Value)

☆ Active to Precharge Delay

5 Set active to Precharge delay timing is 5 clk. (Default value)
6 Set active to Precharge delay timing is 6 clk.
7 Set active to Precharge delay timing is 7 clk.

MAINBOARD BIOS SETUP

☆ DRAM RAS# to CAS# Delay

3 Set SDRAM RAS# to CAS# delay 3 SCLKs.

2 Set SDRAM RAS# to CAS# delay 2 SCLKs.(Default value)

☆ DRAM RAS# Precharge

3 Set SDRAM RAS# Precharge Time to 3. (Default value)

2 Set SDRAM RAS# Precharge Time to 2.

☆ DRAM Read Thermal Mgmt

Select ECC (Error-Checking & Correcting Code) or Non-ECC according to the type of DRAM installed.

☆ System BIOS Cacheable

Selecting Enabled allows caching of the system BIOS ROM at F0000h-FFFFFh, resulting in better system performance. However, if any program writes to this memory area, a system error may result. The settings are: Enabled and Disabled.

☆ Video BIOS Cacheable

Select Enabled allows caching of the video BIOS, resulting in better system performance. However, if any program writes to this memory area, a system error may result. The settings are: Enabled and Disabled.

☆ Video RAM Cacheable

Select Enabled allows caching of the video RAM, resulting in better system performance. However, if any program writes to this memory area, a system error may result. The settings are: Enabled and Disabled.

☆ Memory Hole At 15M-16M

You can reserve this area of system memory for ISA adapter ROM. When this area is reserved, it cannot be cached. The user information of peripherals that need to use this area of system memory usually discusses their memory requirements. The settings are: Enabled and Disabled.

☆ Delayed Transaction

16Min Set active CPU Thermal function after booting 16 Min.(Default Value)

64Min Set active CPU Thermal function after booting 64 Min.

MAINBOARD BIOS SETUP

☆ AGP Aperture Size(MB)

4 AGP Graphics Aperture Size is 4MB.

8 AGP Graphics Aperture Size is 8MB.

16 AGP Graphics Aperture Size is 16MB

32 AGP Graphics Aperture Size is 32MB.

64 AGP Graphics Aperture Size is 64MB. (Default Value)

128 AGP Graphics Aperture Size is 128MB.

256 AGP Graphics Aperture Size is 256MB.

☆ Delay Prior to Thermal

16Min Set active CPU Thermal function after booting 16 Min. (Default Value)

64Min Set active CPU Thermal function after booting 64 Min.

MAINBOARD BIOS SETUP

3.6 Integrated Peripherals

This menu is used to configure the integrated IDE subsystem and other peripherals.

Integrated Peripherals

CMOS Setup Utility - Copyright (C) 1984 - 1999 Award Software

Integrated Peripherals

		Item Help
On-Chip Primary PCI IDE	Enabled	
IDE Primary Master PIO	Auto	Menu Level >
IDE Primary Slave PIO	Auto	
IDE Primary Master UDMA	Auto	
IDE Primary Slave UDMA	Auto	
On-Chip Secondary PCI IDE	Enabled	
IDE Secondary Master PIO	Auto	
IDE Secondary Slave PIO	Auto	
IDE Secondary Master UDMA	Auto	
IDE Secondary Slave UDMA	Auto	
USB Controller	Enabled	
USB Keyboard Supportr	Disabled	
AC97 Audio	Auto	
AC97 Modem	Auto	
Init Display First	AGP	
IDE HDD Block Mode	Enabled	
POWER ON Function	Button only	
X KB Power ON Password	Enter	
X Hot Key Power ON	Ctrl-F1	

↑ ↓ → ←: Move Enter: Select +/-/PU/PD: Value F10: Save ESC: Exit

F1: General Help F5: Previous Value F6: Fail-Safe Defaults F7: Optimized Defaults

MAINBOARD BIOS SETUP

Onboard FDC Controller	Enabled	Item Help
Onboard Serial Port 1	3F8 / IRQ4	Menu Level >
Onboard Serial Port 2	2F8 / IRQ3	
UART Mode Select	Normal	
X UR2 Duplex Mode	Half	
Onboard Parallel Port	378 / IRQ7	
Parallel Port Mode	ECP	
PWRON After PWR-Fail	Off	
Game Port Address	201	
Midi Port Address	330	
Midi Port IRQ	10	

↑ ↓ → ←: Move Enter: Select +/-/PU/PD: Value F10: Save ESC: Exit
F1: General Help F5: Previous Value F6: Fail-Safe Defaults F7: Optimized Defaults

☆ On-Chip primary/Secondary PCI IDE

Select "Enabled" to activate each on-board IDE channel separately, Select "Disabled", if you installed and add-on IDE Control card.

☆ IDE Primary & Secondary Master/Slave PIO

These four PIO fields let you set a PIO mode (0-4) for each of four IDE devices. When Under "Auto" mode, the system automatically set the best mode for each device.

☆ IDE Primary & Secondary Master/Slave UDMA

When set to "Auto" mode, the system will detect if the hard drive supports Ultra DMA mode.

☆ USB Controller

Select Enabled if system contains a Universal Serial Bus (USB) controller.

MAINBOARD BIOS SETUP

☆ USB Keyboard Support

This item lets you enable or disable the USB keyboard driver within the onboard BIOS.

☆ Init Display First

Select "AGP" or "PCI Slot" for system to detect first when boot-up.

☆ AC97 Audio

Allows the motherboard's BIOS to detect whether you are using any audio device. If a Audio device is detected, the onboard audio CODEC will be enabled; If no audio is Detected, the onboard audio CODEC will be disabled. If you want to use different audio Controller cards, set these fields to Disabled.

☆ AC97 Modem

This item allows you to decide to enable/disable the Onboard AC 97' CODEC chipset to support AC 97' Modem. The settings are: Auto, Disabled.

☆ IDE HDD Block Mode

This feature enhances disk performance by allowing multi-sector data transfers and Eliminates the interrupt handling time for each sector.'

☆ Power on Function

This field allows you to use the keyboard to power-on the system. To use this function, make sure JKBV jumper is set to 2-3 pin short, please refer to "Keyboard Voltage Setting " in Chapter 2 for more information.

Any Key: Press any key to power-on the system.

Button Only: System can be power on with Power Button.

Keyboard 98: When this option is selected, press the "wake up" key of the Windows 98 compatible keyboard to power-on the system.

Password: When this option is selected, move the cursor to the "KB Power On Password" field and press <Enter>. Enter your password. You can enter up to 5 characters. Type in exactly the same password to confirm, then press <Enter>.

MAINBOARD BIOS SETUP

Hot Key: When this option is selected, move the cursor to the " Hot Key Power On " field to select a function key you would like to use to power-on the system. The options are from Ctrl-F1 to Ctrl-F12.

Mouse Left: When this option is selected, double-click the right button of the mouse to power-on the system.

☆ Onboard FDC Controller

Select "Enabled" to activate the on-board FDC

Select "Disabled" to activate an add-on FDC

☆ Onboard Serial Port 1 & 2

Select an address and corresponding interrupt for the first/second serial port. The Default value for the first serial port is "3F8/IRQ4" and the second serial port is "2F8/IRQ3".

☆ UART Mode Select

Select to activate the Infrared transfer function.

☆ RxD , TxD Active

This option are Hi, Lo; Lo, Hi; Lo, Lo; Hi, Hi.

☆ IR Transmission Delay

If this option is enabled, transmission of data will be slower. This is recommended when you encounter transmission problem with your device.

☆ Onboard Parallel Port

Select address and interrupt for Parallel port.

☆ Parallel Port Mode

Select an operating mode for the parallel port. Mode options are SPP, EPP, ECP and ECP+EPP.

☆ EPP Mode Select

Set parallel port as EPP1.7 or EPP1.9

☆ ECP Mode Use DMA

Select a DMA channel if parallel port is set as ECP or ECP+EPP.

MAINBOARD BIOS SETUP

☆ PWRON After PWR-Fail

- Off:** When power returns after an AC power failure, the system's power is off. You must press the Power button to power-on the system.
- On:** When power returns after an AC power failure, the system will automatically power-on.
- Former-Sts:** When power returns after an AC power failure, the system will return to the state where you left off before power failure occurs. If the system's power is off when AC power failure occurs, it will remain off when power returns. If the system's power is on when AC power failure occurs, the system will power-on when power returns.

3.7 PC Health Status

Power Management allows you to configure you system to use energy most efficiently, and still in a manner consistent with you own style of computer use.

CMOS Setup Utility - Copyright (C) 1984 - 1999 Award Software

Shutdown Temterature	Disable	Item Help
VCore	1.68 V	Menu Level >
Vcc 3.3 V	1.77 V	
Vcc 5.0 V	5.05 V	
Vcc 12 V	11.12 V	
Vcc -12 V	(-)16.96 V	
Vcc -5.0 V	(-)5.96 V	
Vsb 3.3 V	4.38 V	
Vbat 3.3 V	3.23 V	
System Temperature.	81°C	
CPU Temperature	60°C	
FAN1 Speed	4017 RPM	
FAN2 Speed	0 RPM	
FAN3 Speed	0 RPM	

↑ ↓ → ←: Move Enter: Select +/-/PU/PD: Value F10: Save ESC: Exit

F1: General Help F5: Previous Value F6: Fail-Safe Defaults F7: Optimized Defaults

MAINBOARD BIOS SETUP

☆ Current System & CPU Temperature (xx °C/xx °F)

The onboard hardware monitor is able to detect the temperatures of motherboard and CPU. These values refresh upon any key entry. The function is optional.

☆ Current CPU FAN & CHASS FAN Speed (xxxxRPM)

The onboard hardware monitor is able to detect chassis fan speed, CPU fan speed in Rotations Per Minute (RPM). These values refresh upon any key entry in the BIOS Setup screen. The function is optional.

☆ Vcore, Vcc3, +5V, +12V, -12V, VBAT 3.0V, 5VSB (xx.xxV)

The onboard hardware monitor is able to detect the voltage output by the voltage regulators. These values refresh upon any key entry. The function is optional.

MAINBOARD BIOS SETUP

3.8 Power Management Setup

Power Management allows you to configure you system to use energy most efficiently, and still in a manner consistent with your own style of computer use.

CMOS Setup Utility - Copyright (C) 1984 - 1999 Award Software

Power Management Setup

		Item Help
ACPI function	Enabled	
ACPI Suspend Type	S1 (POS)	Menu Level >
Power Management	User Define	
Video Off Method	DPMS	
Video Off In Suspend	Yes	
Suspend Type	Stop Grant	
MODEM Use IRQ	3	
Suspend Mode	Disabled	
HDD Power Down	Disabled	
Soft-Off by PWR-BTTN	Instant-off	
Wake-Up By PCI & LAN	Enabled	
Power On by Ring	Enabled	
USB KB Wake-Up From S3	Disabled	
Resume by Alarm	Disabled	
x Date (of Month) Alarm	0	
x Time (hh:mm:ss) Alarm	0 : 0 : 0	
Primary IDE 0	Disabled	
Primary IDE 1	Disabled	
Secondary IDE 0	Disabled	
Secondary IDE 1	Disabled	
FDD, COM, LPT Port	Disabled	
PCI PIRQ [A-D] #	Disabled	

↑ ↓ → ←: Move Enter: Select +/-/PU/PD: Value F10: Save ESC: Exit

F1: General Help F5: Previous Value F6: Fail-Safe Defaults F7: Optimized Defaults

MAINBOARD BIOS SETUP

☆ ACPI Function

This item allows you to enable or disable the function of Advanced Configuration and Power Interface which offers improved power management .

☆ ACPI Suspend Type

This field is used to select the type of Suspend function.

S1 (POS): Enables the Power On Suspend function.

S3 (STR): Enables the Suspend to RAM function. Refer to Appendix A.

☆ Power Management

Mini Saving	System starts power saving function when the inactivity period exceeds 1 hour.
Max Saving	System starts power saving function when the inactivity period exceeds 1 min.
User Defined	Allows user to define the inactivity period before power saving function activates,

☆ Video Off Method

This field defines the video off features. The following options are available: DPMS OFF, DPMS Reduce ON, Blank Screen, V/H SYNC+Blank, DPMS Standby, and DPMS Suspend. The DPMS (Display Power Management System) features allow the BIOS to control the video display card if it supports the DPMS feature.

☆ Video Off In Suspend

This option is used to activate the video off feature when the system enters the suspend mode.

☆ Suspend Type

Stop Grant: Set Suspend type is stop grant. (Default value)

Power On: Suspend Set Suspend type is Power on Suspend.

☆ MODEM Use IRQ

This item tells the Power Management BIOS which IRQ is assigned to the installed MODEM Option NA, 3, 4, 5, 7, 9, 10 and 11.

☆ Suspend Mode

System further shuts down all devices except for CPU itself. This is the third level of Power Management.

MAINBOARD BIOS SETUP

☆ HDD Power Down

This instructs hard drives to shut off while in the Power Management modes.

☆ Soft-Off by PWR-BTTN

When set to "Delay 4 Sec", the power button has a dual function where pressing less Than 4 seconds will place the system in sleep mode and shut down the system when The button is held more than 4 seconds. "Instant-Off", the system will be shut down right away when the power button is pressed.

☆ Wake-Up by PCI & LAN

If your PCI card supports PME (Power Management Event) signal and this item is set as Enabled, PCI peripherals drive PME signal to wake the system from low-power States S1-S5.

☆ Power On by Ring

The option lets you specify enable or disable external Modem Wake Up function. It power up the computer when modem receives a call while the computer is in Soft-off mode.

Note: The computer cannot receive or transmit data until the computer and application are fully running. After the item is set as Enabled system must enter to operation System once before system is turned off.

☆ CPU Thermal-Throttling

Set the percent of power consumption when CPU over heat.

☆ Resume by Alarm

Set this option to enable or disable the RTC Alarm to Wake Up the system which is set at soft Off.

☆ Date (of Month) Alarm, Time (hh:mm:ss) Alarm

Set these options to specify the RTC Alarm time on Date / Hour / Minute / Second.

☆ Primary/Secondary IDE 0/1, FDD, COM, LPT Port & PCI PIRQ [A-D]#

These items enable or disable the detection of IDE, floppy, serial, parallel port and PCI PIRQ [A-D] activities for power down state transition. Actually it detects the read/write to/from I/O port.

MAINBOARD BIOS SETUP

3.9 PnP/PCI Configurations

The PCI Personal Component Interconnect Bus was developed to address two important issues: a) How to allow peripheral devices to take the fullest advantage of the power of Pentium and Pentium Pro chip technology, and b) Provide a simpler installation process for peripheral devices, such as Network cards, EIDE or SCSI controllers.

PCI accomplishes these goals with its 32-bit Data path Local Bus design, and support for Plug & Play. Unlike older expansion bus architectures, PCI provides peripherals with a direct connection to the CPU and memory. The PCI bus runs at 33Mhz and has a maximum transfer capability of 132MBps. With Plug & Play, the system BIOS automatically determines hardware resources for new peripherals, simplifying installation of multiple interface cards.

CMOS Setup Utility - Copyright (C) 1984 - 1999 Award Software

PnP / PCI Configurations

Reset Configuration Data	Disabled	Item Help
Resources Controlled By	Auto (ESCD)	Menu Level >
x IRQ Resources	Press Enter	
PCI/VGA Palette Snoop	Disabled	

↑ ↓ → ←: Move Enter: Select +/-/PU/PD: Value F10: Save ESC: Exit

F1: General Help F5: Previous Value F6: Fail-Safe Defaults F7: Optimized Defaults

☆ Reset Configuration Data

In case a conflict occurs after you assign the IRQs or after you configure your system, you can enable this function to allow your system to automatically reset your configuration and reassign the IRQs, DMAs, and I/O address.

MAINBOARD BIOS SETUP

☆ Resources Controlled By

Default setting is "Auto (ESCD)". This setting allows the BIOS to self detect setting and Plug-and-Play devices during start up. The user can select and configure IRQs under "Manual" mode.

When set to Manual, you are able to configure the IRQ and DMA Resources. Pressing <Enter> at the selection field brings up a submenu like the one shown below:

CMOS Setup Utility - Copyright (C) 1984 - 1999 Award Software

IRQ Resources

IRQ	assigned to	Item	Item Help
IRQ-3	assigned to	PCI Device	Menu Level > Legacy ISA for devices compliant with the original PC AT bus Specification, PCI/ISA PnP for devices Compliant with the Plug and Play standard Whether designed for PCI OR ISA bus architecture
IRQ-4	assigned to	PCI Device	
IRQ-5	assigned to	PCI Device	
IRQ-7	assigned to	PCI Device	
IRQ-9	assigned to	PCI Device	
IRQ-10	assigned to	PCI Device	
IRQ-11	assigned to	PCI Device	
IRQ-12	assigned to	PCI Device	
IRQ-14	assigned to	PCI Device	
IRQ-15	assigned to	PCI Device	

↑ ↓ → ←: Move Enter: Select +/-/PU/PD: Value F10: Save ESC: Exit

F1: General Help F5: Previous Value F6: Fail-Safe Defaults F7: Optimized Defaults

☆ IRQ3/4/5/7/9/10/11/12/14/15 assigned to

By default, all resources are assigned to the PCI Bus. If an ISA card requires a particular IRQ, those resources should be set to Legacy ISA so that the PCI Bus will not try to use them.

Choices are Legacy ISA and PCI/ISA PnP.

Pressing <Enter> at **DMA Resources** brings up a submenu that gives you the following options:

MAINBOARD BIOS SETUP

3.10 Frequency / Voltage Control

Use this menu to specify your settings for frequency/voltage control. Frequency Control

CMOS Setup Utility - Copyright (C) 1984 - 1999 Award Software

Frequency Control

CPU Clock Ratio	8 X	Item Help
Auto Detect DIMM/PCI Clk	Enabled	Menu Level >
Spread Spectrum	Enabled	

↑ ↓ → ←: Move Enter: Select +/-/PU/PD: Value F10: Save ESC: Exit

F1: General Help F5: Previous Value F6: Fail-Safe Defaults F7: Optimized Defaults

☆ Auto Detect DIMM/PCI Clk

When *enabled*, any DIMM/PCI clock not in use will be disabled to reduce EMI radiation.

☆ Spread Spectrum

The default is the optimal value determined by the system designer to reduce EMI radiation peak. Users should not attempt to change it.

☆ CPU Host Clock (CPU/PCI)

This option lets you select the CPU/PCI Bus clock. Over-clocking may cause serious system damage.

MAINBOARD BIOS SETUP

3.11 Load Fail-Safe Defaults

Loads Fail Safe settings into the BIOS Setup program. These options are designed to slow the system down for troubleshooting purposes. To load the default values, highlight this option and press [ENTER]. Enter Y in the confirmation screen and press [ENTER] again. User-defined options in the **Standard CMOS Setup** are not affected.

3.12 Load Optimized Defaults

Loads the default values for best system performance into the BIOS Setup program. To load the default values, highlight this option and press [ENTER]. Enter Y in the confirmation screen and press [ENTER] again. User-defined options in the **Standard CMOS Setup** are not affected.

3.13 Supervisor Password and User Password

Setting

Passwords can be set to provide protection for the BIOS configuration options, or to restrict access to the computer itself. When enabled, User Password will require all users to enter a password in order to use the system, and/or enter the BIOS setup (but can't change its contents). A Supervisor Password is used to protect the stored CMOS options from being changed by unauthorized users.

Keep in mind that when set, a password is required only when booting the system. It will not provide protection to a system that is already booted. The password check option is set in **Advanced BIOS Features** by choosing either System (the password prompt appears every time the system is powered on) or Setup (the password prompt appears only when the user enters the BIOS Setup). The password is stored in CMOS RAM, and can be cleared by the Clear CMOS jumper. (Refer to page 14.)

MAINBOARD BIOS SETUP

☆ To set a password:

1. You must first set the *Supervisor* password by choosing *Supervisor Password* and pressing [ENTER]. Setup prompts for a password.
2. Enter a 1-8 character password using letters, numbers, or a combination of both. The specific characters are not shown as you enter them. Press [ENTER].
3. A confirmation box appears asking you to re-enter the password. Enter the password again. Press [ENTER] Follow the same procedure to set the User Password.

☆ Changing a Password:

Select the appropriate password option (Supervisor or User) from the main menu and press [ENTER]. Enter the current password and press [Enter]. The screen does not display the characters entered. Enter in the new password, then the confirmation. You cannot change the current password unless you know it.

☆ Erasing a Password:

1. If you know the current password, but want to disable password checking, follow the procedure for changing the password. When Setup prompts for the new password, simply press [ENTER]. You will see a message indicating that the password is disabled.
2. If you do not know the current password, the CMOS must be cleared by cleared by the Clear CMOS jumper (Refer to page 14). *This will clear all user-defined BIOS Setup options.

3.14 Save & Exit Setup / Exit Without Saving

Select Save & Exit Setup to save into the CMOS memory all modifications specified during the current session. To save the configuration changes, highlight this option in the main menu and press [ENTER]. The system displays a confirmation message on the screen. Press the Y key and then [Enter]. Press the N key and then the [Enter] key to abort. The Exit Without Saving option allows the user to exit the BIOS Setup without updating any changes made during the current session.

MAINBOARD BIOS SETUP

3.15 PCI Device Listing

This list of installed PCI devices appears after the **System Configuration** screen:

PCI device listing			Vendor/Driver	Class	Device Class	IRQ
Bus No.	Device No.	Func No.	8086 224B	0101	IDE Controller	14
0	31	1	8086 2242	0C03	Serial Bus Controller	5
0	31	2	8086 2243	0C05	SMBus Controller	9
0	31	3	8086 2244	0C03	Serial Bus Controller	11
0	31	4	8086 2245	0401	Multimedia Device	9
0	31	5	10DE 8139	0300	Display controller	11
1	0	0	10EC	0200	Network controller	9
2	7	0			ACPI controller	

Bus No. Encoded value indicating 1 of 256 possible buses in a system.

Device No. Encoded value indicating 1 of 32 possible devices on a given bus.

Func No. Encoded value indicating 1 of 8 possible functions on a multifunction device.

Vendor ID. Identifies the manufacturer of the device. Valid vendor identifiers are allocated by the PCI SIG (Special Interest Group) to ensure uniqueness.

Device ID. Identifies the particular device. This identifier is allocated by the vendor.

Device CLASS. Specifies one of the following device classes: Mass storage controller, Network controller, Display controller, Multimedia device, Bridge device, Simple communication controller, Base system peripherals, Input device, Docking station, Processor and Serial bus controller.

The PCI device listing is useful for troubleshooting purposes. More detailed information for each field may be obtained through the PCI specification documentation.

FLASH BIOS PROGRAMMING UTILITY

4. FLASH BIOS PROGRAMMING UTILITY

Updating the Award BIOS Code is made easy with the AWDFLASH Utility found under the Utilities folder of the supplied CD-ROM. Since this mainboard features FLASH BIOS, it is not necessary to change the actual BIOS chip in order to upgrade the System BIOS. The user can simply re-program the old BIOS using the AWDFLASH Utility as follows:

1. First, boot the system with DOS or to Safe mode command prompt only under Windows 95/98. If you are booting DOS from a hard drive or floppy disk, press [F5] when the message Starting MS-DOS appears on the screen. If you are booting Windows 95/98, press the [F8] key, and select the Safe mode command prompt only option. This will assure that the system is running in **real mode** with **no device drivers loaded**. This is the only correct way to run the AWDFLASH Utility program.
2. There are (2) important files needed to re-program the BIOS. The first is AWDFLASH.EXE which is the FLASH BIOS Programming Utility. The second file needed is the updated BIN file which contains the actual BIOS code. This file will have the extension [.bin], such as P598GH.BIN . Make sure these files are on the diskette or hard drive in the same directory.
3. Start the AWDFLASH Utility by changing to the directory where the two required files exist, typing: AWDFLASH and pressing [ENTER].
4. The AWDFLASH Utility Screen appears. You will be asked for the file name to program. Type in the name of the new BIOS (.bin) file and hit [ENTER].

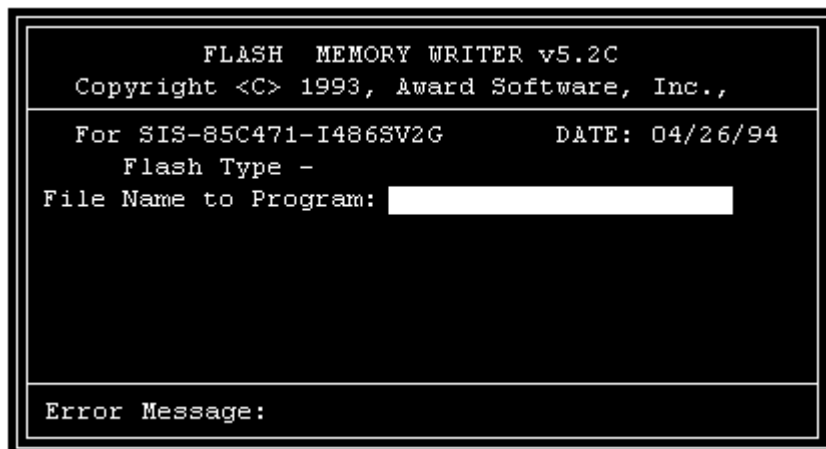

FLASH BIOS PROGRAMMING UTILITY

5. The program will then ask if you want to backup the old BIOS. This is recommended in case there are any problems with the new .bin file. Enter the name of the new backup file (such as backup.bin) and press [ENTER].

6. At this time the system will prompt you for final confirmation before beginning programming. The Utility can be aborted at this time by hitting n . To begin programming, hit y

7. When the Flash programming starts, a bar indicator will show the progress of the programming operation. After successful completion, hit the reset button or power off the computer.

Be sure to perform **Load Optimized Defaults** for your new BIOS to synchronize the previous BIOS with the updated BIOS.

DMI UTILITY

5. DMI UTILITY

This main board supports the **Desktop Management Interface (DMI)**, which is a new method of providing enterprise management for personal computers. The main component of DMI is the Management Information Format Database (MIF), which contains information about the computer system and its components, such as BIOS version/vendor, CPU speed/type, memory size/type, L1/L2 cache, port connectors (IDE, floppy, 2S/1P, USB, keyboard, mouse), slots etc. Using DMI,

remote PC management software is able to obtain various information about the system, including hardware profiles, capabilities, operational status, installation dates, and other information about the system and its components. This DMI utility, DMICFG.EXE found under the Utilities folder of the supplied CD-ROM, allows you to add additional information, such as serial numbers, vendor information, and enclosure/chassis configurations, into the MIF.

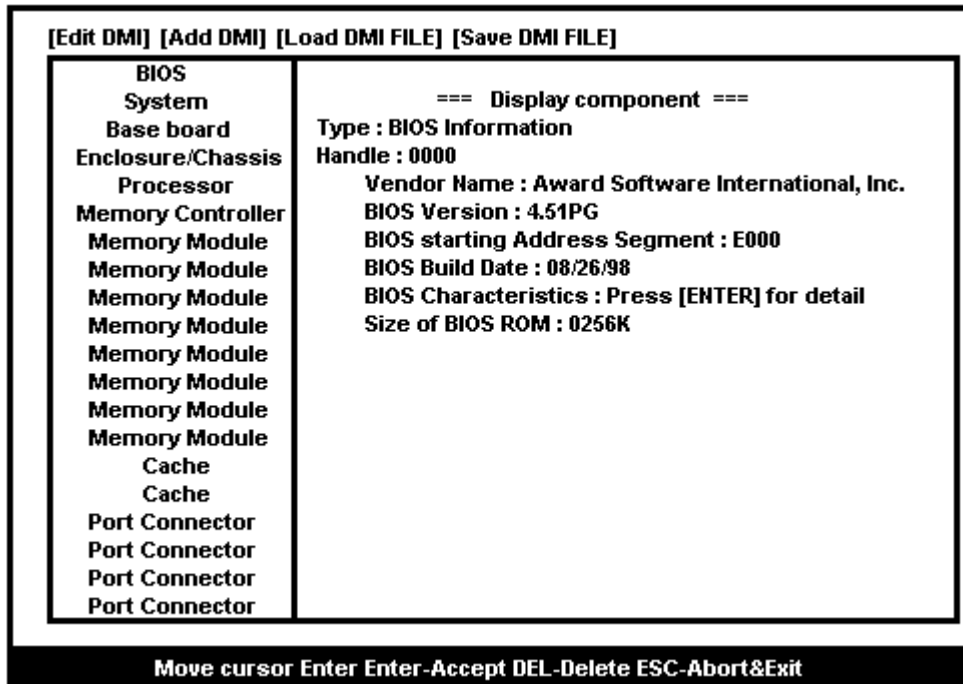

Note: The DMI utility must be run in real mode without the EMM386 memory manager loaded.

INSTANTLY AVAILABLE PC

6. INSTANTLY AVAILABLE PC (Option)

(for the Main board Chipset with FW82815EP only)

6.1 What is an Instantly Available PC?

Instantly Available Technology Boosts PC Energy Savings and Improves PC's Ease of Use at full system capability

Wouldn't it be nice if your personal computer is ready when you are, just like any home appliance, with just a touch of a button? How about keeping your personal computer available 24 hours a day to answer phones, receive faxes, and connect users to each other, with power consumption no more than a night light?

It's here the Instantly Available PC is here to bring these new capabilities to PC users!

With an Instantly Available PC, users can allow their PCs to power down to a very deep sleep state, consuming very little power, while retaining the capability to respond to various external or user programmed events such as a phone call, network alerts or a backup procedure. And the wakeup is quick, within a few seconds. So no more time-consuming shutdown/restart/reboot process to interrupt and resume operation!

6.2 Core Technology Suspend to RAM (S3)

The ideal sleep state with the lowest power consumption for an Instantly Available PC is **Suspend to RAM (STR)**. In this state over 95% of the PC's power is shut off while the system context is maintained in system memory, enabling a breakthrough in power savings while maintaining full system capability and connectivity.

Suspend To RAM (STR) is defined by the Advanced Configuration and Power Interface (ACPI) specification as the **S3** sleep state. ACPI is a power management specification proposed by Intel, Toshiba and Microsoft, which makes hardware status information available to the operating system and is an Operating System Directed Power Management.

INSTANTLY AVAILABLE PC

☆ APM vs. ACPI

The old generation APM (Advanced Power Management) is a BIOS directed power management can be activated to save energy, but at the expense of system performance and/or connectivity due to its unawareness of the system states.

With ACPI and Suspend to RAM technology, the user will not have to make any tradeoffs when it comes to power management. Network and modem connections will still be there and you will enjoy full system capabilities along with aggressive power management.

6.3 The Key Ingredients

- > An ACPI -enabled Operating System such as Microsoft Windows 98 or Windows 2000 family is required to direct the system-wide power management.
- > BIOS on Motherboard must support **ACPI** and **Suspend to RAM (STR)** sleep state.
- > Hardware circuits, especially **Auxiliary Power Source** and **Split Power Planes** must be implemented on motherboard.
- > Add-on adapters must support ACPI capabilities to make whole system **Instantly Available**. Refer to Add-on Device Compatibility List.
- > ATX power must comply with **ATX 2.01** specification (Provide more than **720MA** Stand-By current at 5V)

INSTANTLY AVAILABLE PC

6.4 Installation

☆ Mainboard BIOS

Enable the ACPI option provided in the BIOS by:

1. Enter **Power Management Setup** of the BIOS.
2. Set **ACPI function** to **Enabled**.
3. Set **ACPI Suspend Type** to **S3 (STR)**.

☆ Operating System

If your existing 98 system is in APM mode, update the system to ACPI mode as follows:

1. Boot-up with Windows 98.
2. Open the **"Control Panel"** and double-click the **"System"** icon.
3. Click the **"Device Manager"** Tab and then the **"System devices"**.
4. Double-click the **"Plug and Play BIOS"**.
5. Click the **"Driver"** Tab and choose **"Update Driver"**.
6. **"Update Device Driver Wizard"** starts. Click on the **"Next"** button.
7. The Wizard provides a choice between having the Wizard search for a better driver than the one in use or displaying a list of drivers from a specific location. Choose **"Display"** and click on the **"Next"** button.
8. Select **"Show all hardware"** and then **"Advanced Configuration and Power Interface (ACPI) BIOS"**.
9. Click on the **"Next"** button.
10. An **"Update Driver Warning"** dialog box appears. Click on the **"Yes"** button.
11. **"Update Device Driver Wizard"** will starts again. Click on the **"Next"** button.
12. When copying files to the system is completed, click on the **"Finish"** button.
13. Restart the computer. Your windows 98 system is in the ACPI mode.

INSTANTLY AVAILABLE PC

6.5 Using Suspend to RAM

☆ How to put your system into Suspend to RAM (STR) sleep state

There are several ways to initiate Suspend to RAM(STR):

Note: The Message LED should be blinking while system is in standby, Suspend to RAM mode. Depending on the mainboard and the chassis designs, the Message LED may be the Power LED or other LED on the front panel of the chassis.

☆ Using the mouse button:

1. From the "**Start**" menu in Windows 98, select "**Shut Down**".
2. Select "**Stand by**" in the Shut Down Windows dialog box.
3. Press "**OK**" to enter the "**Suspend to RAM (STR)**" sleep state.

☆ Setting the standby time

1. Enter "**Control Panel**".
2. Double-click the "**Power Management**" icon.
3. "Power Management Properties" dialog box appears. Select "**Power Schemes**" tab.
4. Use "**System standby**" option to set the time for the system to automatically enter standby mode when the system is not in use.

☆ Using the system power button:

1. Enter "**Control Panel**".
2. Double-click the "**Power Management**" icon.
3. In the Power Management Properties dialog box, select "**Advanced**" tab.
4. Define the System Power Button to be "**Standby**" or "**Shutdown**":

☆ Standby

When the power switch of the front bezel or "**Sleep**" key of the Windows 98 keyboard is pressed, Windows 98 will enter "**Suspend to RAM**" mode and later can be waken up by pressing the "**Wake up**" key or power switch.

Now you can press the Power on button to enter the "**Suspend to RAM (STR)**" sleep state.

☆ Shutdown

System is turned off almost immediately without corrupting the data.

INSTANTLY AVAILABLE PC

☆ Using the Windows 98 keyboard buttons:

Press the "**Sleep**" button to enter the Suspend to RAM mode.

Note: 1. The "Power Off" button on the Windows 98 keyboard can also be used to enter the standby mode as described above.

2. You need to set the mainboard BIOS to use the "Wakeup" button.

Please see the following section.

☆ How to recover your system from "Suspend to RAM (STR)" sleep state

You can set the way to wake up the system from the mainboard BIOS Setup:

☆ At the Integrated Peripherals Setup Screen, under "Wake Up Events":

☆ **Keyboard Resume** Enabling this option allows pressing any key on the keyboard to wake up a system which has been powered down.

☆ **Wake Up On LAN/Ring** An input signal on the serial Ring Indicator (RI)

line in other words, an incoming call on the modem (either external modem or internal modem card) power on the system.

With a LAN card installed, the Wake-up On LAN function allows the network to wake up a Soft Power Down (Soft-Off) PC.

☆ **RTC Alarm Resume** - When enabled, the system will automatically power on or returns to full power out of suspend/standby mode at the time and date of the month (0 for daily) specified.

6.6 Related Documents

■ ACPI, Advanced Configuration and Power Interface Revision 1.0b,

<http://www.teleport.com/~acpi/spec.htm>

■ ACPI Implementers' Guide,

<http://www.teleport.com/~acpi/impguid.htm>

■ Instantly Available PC Technology,

<http://developer.intel.com/technology/iapc/>

■ On Now White papers,

<http://www.microsoft.com/hwdev/onnow.htm/>

Software Installation

7. Software Installation

7.1 Please Select Model Name

Included in the Motherboard package you can find a CD-disk which contains the support drivers & utilities. Please insert this support CD-disk into your CD-ROM drive of PC, wait for the Autorun Screen then click "**PT-845DDR-A(AN)**" for into the drivers & utilities installation.

Step1

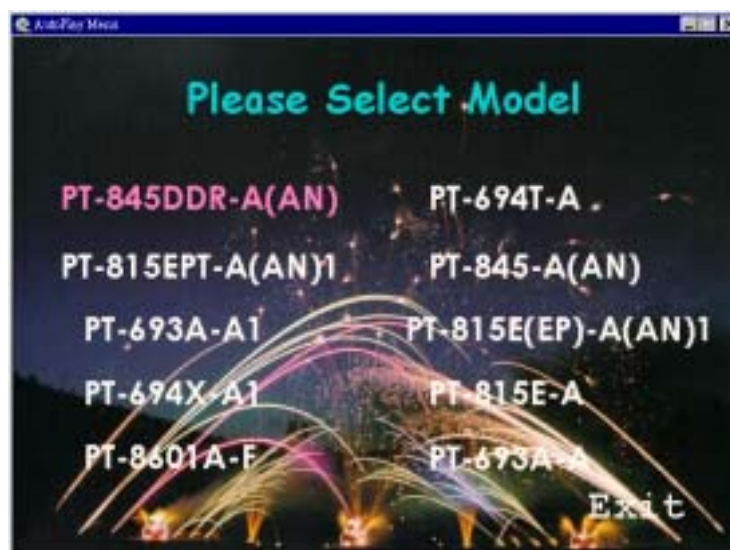

Step2



Software Installation

7.2 Install I845 Drivers

Click "Install 845 Drivers".

Please follow the step charts below for installation.

Step1

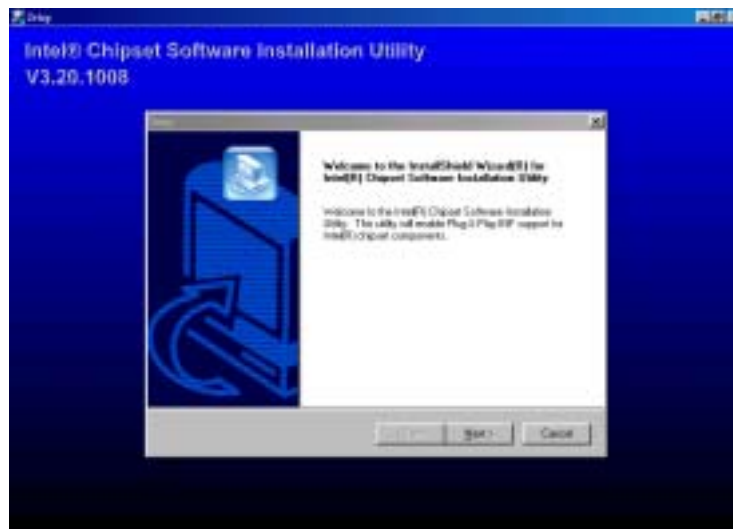

Step2

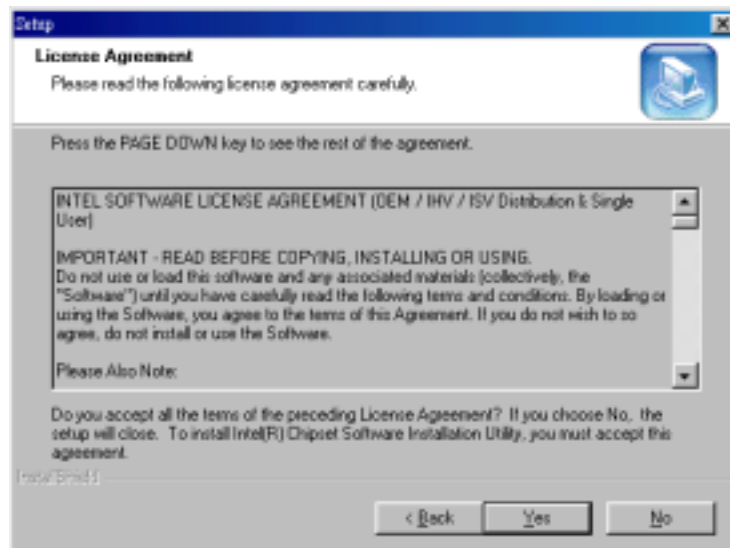

Software Installation

Step3

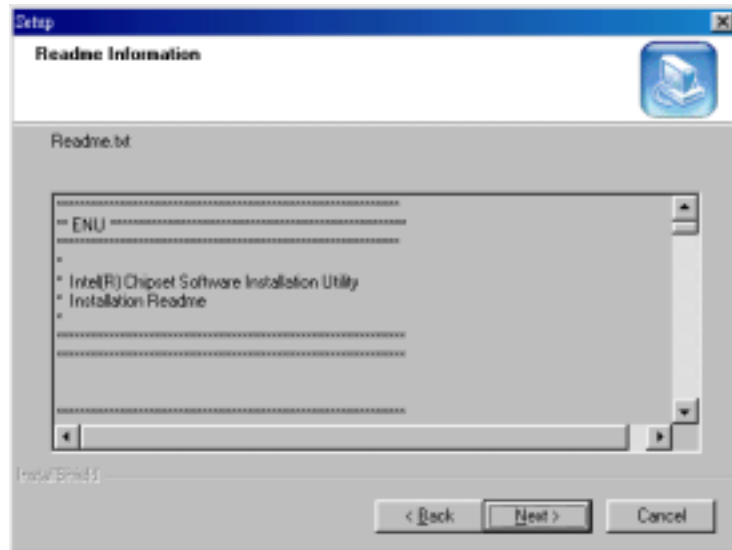

Step4

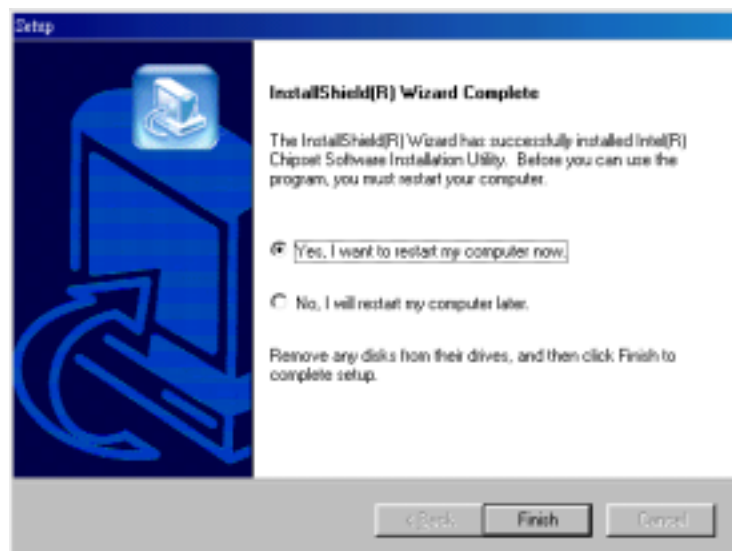

Software Installation

7.3 Install Sound Driver

Click "Install Sound Driver"

Please follow the step charts below for installation

Step1

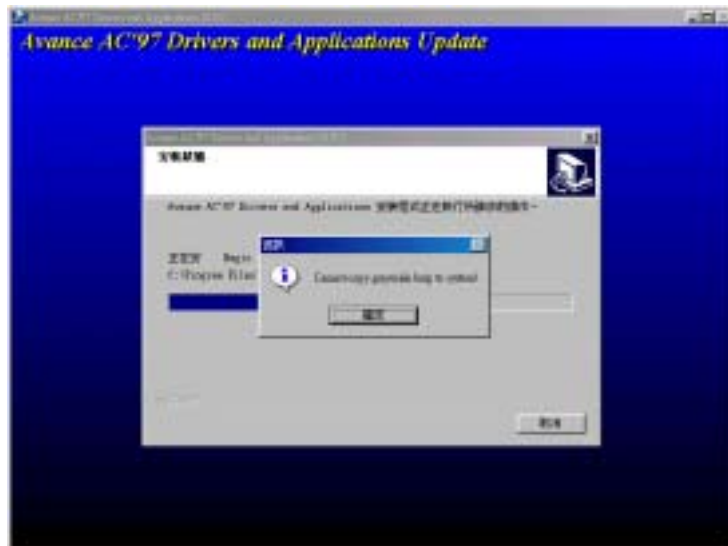

Step2



Software Installation

7.4 Install LAN Driver (for AN only)

Please refer to the Ms98nt5.txt file that in RTL 8100\TXTMS\ directory first before installing the LAN driver.

Step1



Step2

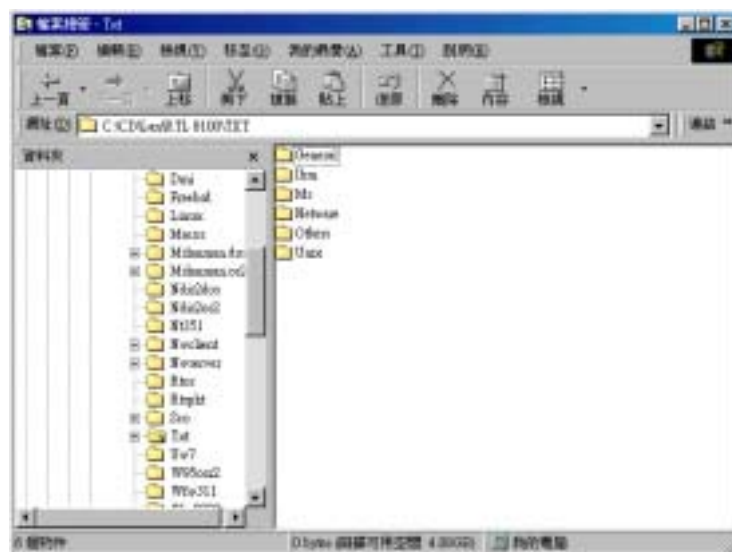

Software Installation

7.5 Install Adobe Acrobat Reader

Click "Install Adobe Acrobat Reader"

Please follow the step charts below for installation.

Step1



Step2



Software Installation

7.6 Install IDE Driver

Click "Install IDE Driver"

Please follow the step charts below for installation

Step1

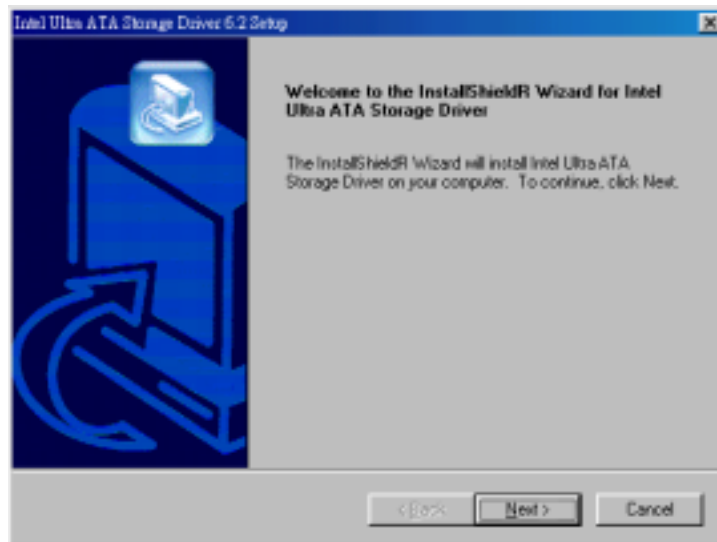

Step2

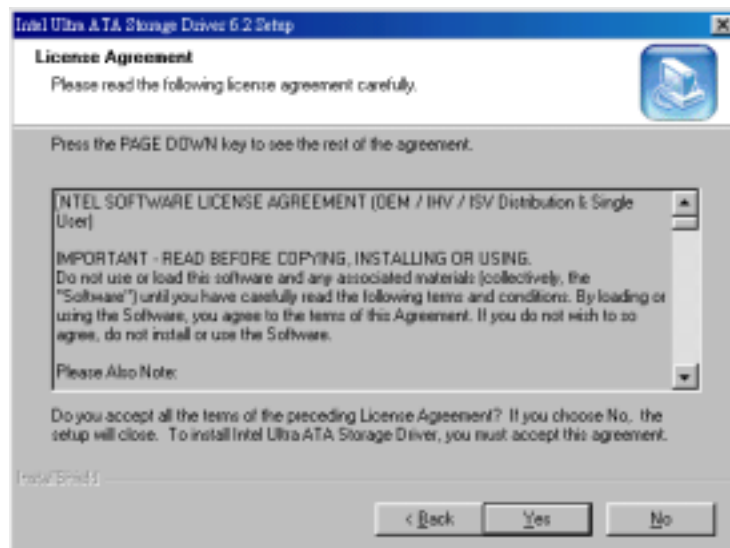

Software Installation

Step3

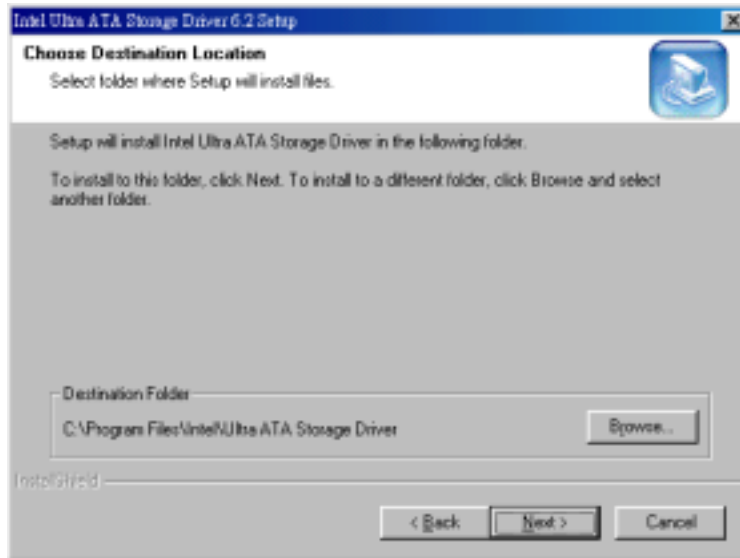

Step4

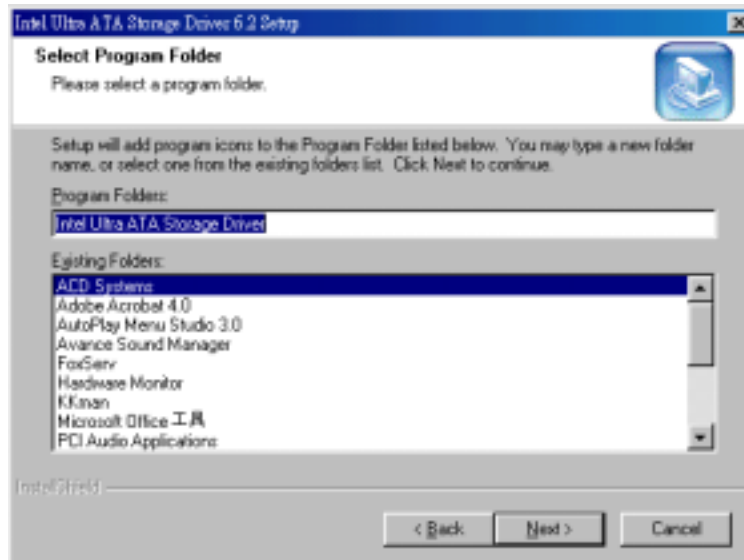

Software Installation

Step5

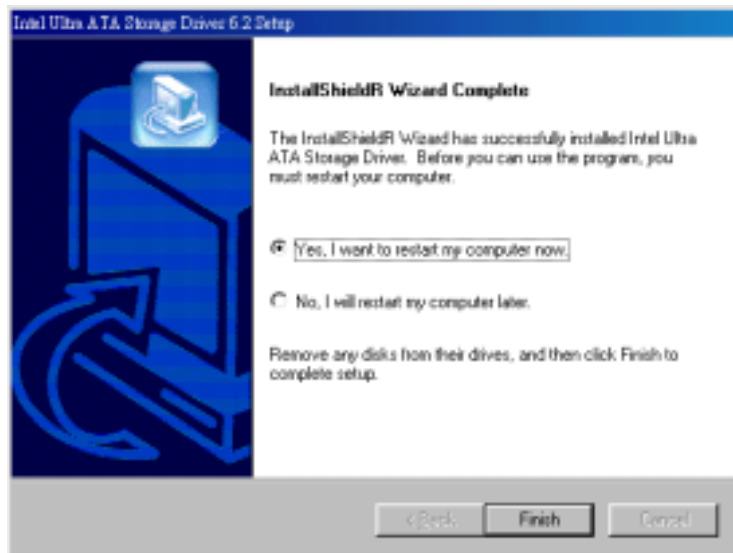

7.8 Other Driver Search

Click "Other Driver Search" for other drivers & utilities demand.

Step1

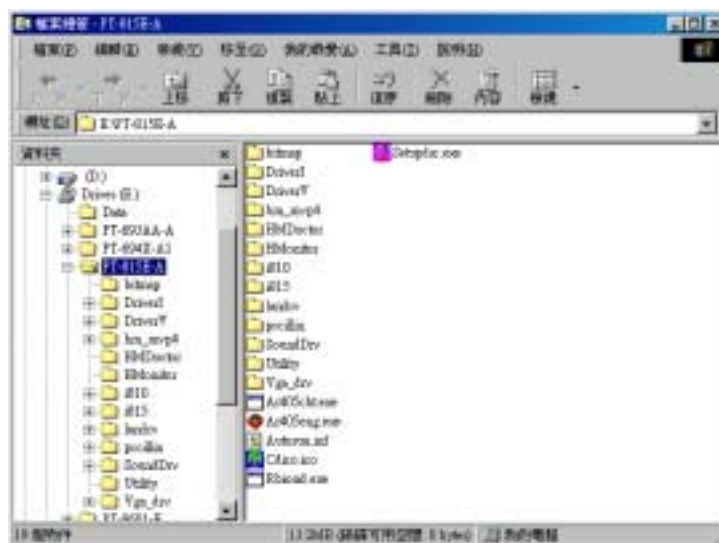

Appendix

8. Appendix

8.1 Update Your system BIOS

Download the XXXXX.EXE file corresponding to your model from our website to an empty directory on your hard disk or floppy. Run the downloaded XXXXX.EXE file and it will self extract. Copy these extracted files to a bootable DOS floppy disk.

Note: The DOS floppy disk should contain NO device drivers or other programs.

1. Type "A:\AWDFLASH and press <Enter> Key.
2. You will see the following setup on screen.
3. Please key in the XXXXX.bin BIOS file name.

```
FLASH MEMORY WRITER V7.88
(C) Award Software 2000 All Right Reserved

For XXXX-W83627-6A69LPA9C-0  DATE: 05/11/2000
Flash Type -
File Name to Program: _____

Error Message:
```

4. If you want to save the previous BIOS data to the diskette, please key in [Y], otherwise please key in [N].

```
FLASH MEMORY WRITER V7.88
(C) Award Software 2000 All Right Reserved

For XXXX-W83627-6A69LPA9C-0  DATE: 05/11/2000
Flash Type - XXXXX E82802AB /3.3V
File Name to Program: XXXXX.bin

Error Message: Do You Want To Save Bios (Y/N)
```

Appendix

5. Key in File Name to save previous BIOS to file.

```
FLASH MEMORY WRITER V7.88
(C)Award Software 2000 All Right Reserved

For XXXX-W83627-6A69LPA9C-0  DATE: 05/11/2000
Flash Type - XXXXX E82802AB /3.3V

File Name to Program: XXXXX.bin
File Name to Save   : XXXXX.bin

Error Message:
```

6. Are you sure to program (y/n), please key in [Y] to start the programming.

```
FLASH MEMORY WRITER V7.88
(C)Award Software 2000 All Right Reserved

For XXXX-W83627-6A69LPA9C-0  DATE: 05/11/2000
Flash Type - XXXXX E82802AB /3.3V

File Name to Program: XXXXX.bin
Checksum : 938EH
File Name to Save   : XXXXX.bin

Error Message:  Are you sure to program (y/n)
```

7. The programming is finished.

```
FLASH MEMORY WRITER V7.88
(C)Award Software 2000 All Right Reserved

For XXXX-W83627-6A69LPA9C-0  DATE: 05/11/2000
Flash Type - XXXXX E82802AB /3.3V

File Name to Program: XXXXX.bin
Checksum : 4B04H
Veriyng Flash Memory - 7FE00 OK

████████████████████████████████████████████████████████████████████████████████
█ Write OK      █ No Update      █ Write Fail

F1: Reset      F10: Exit
```