



ALiveXFire-eSATA2

User Manual

Version 1.0

Published September 2006

Copyright©2006 ASRock INC. All rights reserved.

Copyright Notice:

No part of this manual may be reproduced, transcribed, transmitted, or translated in any language, in any form or by any means, except duplication of documentation by the purchaser for backup purpose, without written consent of ASRock Inc.

Products and corporate names appearing in this manual may or may not be registered trademarks or copyrights of their respective companies, and are used only for identification or explanation and to the owners' benefit, without intent to infringe.

Disclaimer:

Specifications and information contained in this manual are furnished for informational use only and subject to change without notice, and should not be constructed as a commitment by ASRock. ASRock assumes no responsibility for any errors or omissions that may appear in this manual.

With respect to the contents of this manual, ASRock does not provide warranty of any kind, either expressed or implied, including but not limited to the implied warranties or conditions of merchantability or fitness for a particular purpose.

In no event shall ASRock, its directors, officers, employees, or agents be liable for any indirect, special, incidental, or consequential damages (including damages for loss of profits, loss of business, loss of data, interruption of business and the like), even if ASRock has been advised of the possibility of such damages arising from any defect or error in the manual or product.



This device complies with Part 15 of the FCC Rules. Operation is subject to the following two conditions:

- (1) this device may not cause harmful interference, and
- (2) this device must accept any interference received, including interference that may cause undesired operation.

ASRock Website: <http://www.asrock.com>

Contents

1. Introduction	5
1.1 Package Contents	5
1.2 Specifications	6
1.3 Minimum Hardware Requirement Table for Windows® Vista™ Premium and Basic Logo	9
1.4 Motherboard Layout	10
1.5 ASRock 8CH_eSATAII I/O	11
2. Installation	12
Pre-installation Precautions	12
2.1 CPU Installation	13
2.2 Installation of CPU Fan and Heatsink	13
2.3 Installation of Memory Modules (DIMM)	14
2.4 Expansion Slots (PCI and PCI Express Slots)	16
2.5 Installing a Single Graphics Card	18
2.6 Installing CrossFire™ Graphics Cards	19
2.7 Surround Display Feature	23
2.8 Jumpers Setup	23
2.9 Onboard Headers and Connectors	24
2.10 HDMI_SPDIF Header Connection Guide	29
2.11 eSATAII Interface Introduction	30
2.12 SATAII Hard Disk Setup Guide	33
2.13 Serial ATA (SATA) / Serial ATAII (SATAII) Hard Disks Installation	34
2.14 Hot Plug and Hot Swap Functions for SATA / SATAII HDDs and eSATAII Devices	34
2.15 Driver Installation Guide	35
2.16 Installing Windows® 2000 / XP / XP 64-bit / Vista™ With RAID Functions	36
2.17 Installing Windows® 2000 / XP / XP 64-bit / Vista™ Without RAID Functions	37
2.17.1 Installing Windows® 2000 / XP / XP 64-bit Without RAID Functions	37
2.17.2 Installing Windows® Vista™ Without RAID Functions	39
2.18 Untied Overclocking Technology	39
3. BIOS SETUP UTILITY	40
3.1 Introduction	40
3.1.1 BIOS Menu Bar	40
3.1.2 Navigation Keys	41

3.2	Main Screen	41
3.3	Advanced Screen	42
3.3.1	CPU Configuration	43
3.3.2	Chipset Configuration	45
3.3.3	ACPI Configuration	47
3.3.4	IDE Configuration	48
3.3.5	PCIPnP Configuration	50
3.3.6	Floppy Configuration	50
3.3.7	Super IO Configuration	51
3.3.8	USB Configuration	52
3.4	Hardware Health Event Monitoring Screen	53
3.5	Boot Screen	54
3.5.1	Boot Settings Configuration	54
3.6	Security Screen	55
3.7	Exit Screen	56
4.	Software Support	57
4.1	Install Operating System	57
4.2	Support CD Information	57
4.2.1	Running Support CD	57
4.2.2	Drivers Menu	57
4.2.3	Utilities Menu	57
4.2.4	Contact Information	57
	APPENDIX: AMD's Cool 'n' Quiet™ Technology.....	58

1. Introduction

Thank you for purchasing ASRock **ALiveXFire-eSATA2** motherboard, a reliable motherboard produced under ASRock's consistently stringent quality control. It delivers excellent performance with robust design conforming to ASRock's commitment to quality and endurance.

In this manual, chapter 1 and 2 contain introduction of the motherboard and step-by-step guide to the hardware installation. Chapter 3 and 4 contain the configuration guide to BIOS setup and information of the Support CD.



Because the motherboard specifications and the BIOS software might be updated, the content of this manual will be subject to change without notice. In case any modifications of this manual occur, the updated version will be available on ASRock website without further notice. You may find the latest VGA cards and CPU support lists on ASRock website as well. ASRock website <http://www.asrock.com>

1.1 Package Contents

- 1 x ASRock **ALiveXFire-eSATA2** Motherboard
(ATX Form Factor: 12.0-in x 8.2-in, 30.5 cm x 20.8 cm)
- 1 x ASRock **ALiveXFire-eSATA2** Quick Installation Guide
- 1 x ASRock **ALiveXFire-eSATA2** Support CD
- 1 x Ultra ATA 66/100/133 IDE Ribbon Cable (80-conductor)
- 1 x 3.5-in Floppy Drive Ribbon Cable
- 4 x Serial ATA (SATA) Data Cables (Optional)
- 2 x Serial ATA (SATA) HDD Power Cables (Optional)
- 1 x HDMI_SPDIF Cable (Optional)
- 1 x ASRock 8CH_eSATAII I/O Shield
- 1 x USB Bracket
- 1 x PCIE Switch Card



This motherboard is bundled with one PCIE Switch card installed on PCIE2/ PCIE SWITCH slot, which allows you better flexibility to choose PCIE functions between one PCIE x16 slot and two PCIE slots for ATI™ CrossFire™ without setting up jumpers.

1.2 Specifications

Platform	- ATX Form Factor: 12.0-in x 8.2-in, 30.5 cm x 20.8 cm
CPU	- Socket AM2 for AMD Athlon™ 64FX / 64X2 / 64 and Sempron Processors - AMD LIVE!™ Ready - Supports AMD's Cool 'n' Quiet™ Technology (see CAUTION 1) - FSB 1000 MHz (2.0 GT/s) - Supports Untied Overclocking Technology (see CAUTION 2) - Supports Hyper-Transport Technology
Chipset	- Northbridge: ATI™ CrossFire™ Xpress 1600 (RD480) - Southbridge:ATI™ SB600
Memory	- Dual Channel DDRII Memory Technology (see CAUTION 3) - 4 x DDRII DIMM slots - Support DDRII800/667/533 - Max. capacity: 8GB
Hybrid Booster	- CPU Frequency Stepless Control (see CAUTION 4) - ASRock U-COP (see CAUTION 5) - Boot Failure Guard (B.F.G.) - ASRock AM2 Boost: ASRock Patented Technology to boost memory performance up to 12.5% (see CAUTION 6)
Expansion Slot	- Supports ATI™ CrossFire™ graphics cards (see CAUTION 7) - 1 x PCI Express x16 slot with PCIE Switch card or 2 x PCI Express Graphics slots for ATI™ CrossFire™ (see CAUTION 8) - 1 x PCI Express x1 slot - 3 x PCI slots
Audio	- 7.1 CH Windows® Vista™ Premium Level HD Audio (ALC888 Audio Codec)
LAN	- Gigabit LAN 10/100/1000 Mb/s - PCIe x1 Realtek RTL8111B - Supports Wake-On-LAN
Rear Panel I/O	ASRock 8CH_eSATAII I/O - 1 x PS/2 Mouse Port - 1 x PS/2 Keyboard Port - 1 x Serial Port: COM1 - 1 x Parallel Port (ECP/EPP Support) - 2 x Ready-to-Use USB 2.0 Ports - 2 x eSATAII Ports

	<ul style="list-style-type: none"> - 1 x RJ-45 Port - HD Audio Jack: Side Speaker/Rear Speaker/Central/Bass/Line in/Front Speaker/Microphone (see CAUTION 9)
Connector	<ul style="list-style-type: none"> - 4 x SATAII 3.0Gb/s connectors, support RAID (RAID 0, RAID 1 and RAID 10), NCQ, AHCI and "Hot Plug" functions (see CAUTION 10) - 2 x eSATAII 3.0Gb/s connectors (shared with 2 SATAII ports), support RAID (RAID 0 and RAID 1), NCQ, AHCI and "Hot Plug" functions (see CAUTION 11) - 1 x ATA133 IDE connector (supports 2 x IDE devices) - 1 x Floppy connector - 1 x IR header - 1 x Game header - 1 x HDMI_SPDIF header - CPU/Chassis FAN connector - 20 pin ATX power connector - 4 pin 12V power connector - SLI/XFire power connector - CD in header - Front panel audio connector - 4 x USB 2.0 headers (support 8 USB 2.0 ports) (see CAUTION 12)
BIOS Feature	<ul style="list-style-type: none"> - 4Mb AMI BIOS - AMI Legal BIOS - Supports "Plug and Play" - ACPI 1.1 Compliance Wake Up Events - Supports jumperfree - SMBIOS 2.3.1 Support
Support CD	<ul style="list-style-type: none"> - Drivers, Utilities, AntiVirus Software (Trial Version)
Hardware Monitor	<ul style="list-style-type: none"> - CPU Internal Temperature Sensing - CPU Ambient Temperature Sensing - Chassis Temperature Sensing - CPU Fan Tachometer - Chassis Fan Tachometer - CPU Quiet Fan - Voltage Monitoring: +12V, +5V, +3.3V, Vcore
OS	<ul style="list-style-type: none"> - Microsoft® Windows® 2000/XP/XP Media Center/XP 64-bit/Vista™ compliant (see CAUTION 13)
Certifications	<ul style="list-style-type: none"> - FCC, CE, Microsoft® WHQL Certificated

CAUTION!

1. For power-saving's sake, it is strongly recommended to enable AMD's Cool 'n' Quiet™ technology under Windows system. See APPENDIX on page 58 to enable AMD's Cool 'n' Quiet™ technology.
2. This motherboard supports Untied Overclocking Technology. Please read "Untied Overclocking Technology" on page 39 for details.
3. This motherboard supports Dual Channel Memory Technology. Before you implement Dual Channel Memory Technology, make sure to read the installation guide of memory modules on page 14 for proper installation.
4. Although this motherboard offers stepless control, it is not recommended to perform over-clocking. Frequencies other than the recommended CPU bus frequencies may cause the instability of the system or damage the CPU.
5. While CPU overheat is detected, the system will automatically shutdown. Before you resume the system, please check if the CPU fan on the motherboard functions properly and unplug the power cord, then plug it back again. To improve heat dissipation, remember to spray thermal grease between the CPU and the heatsink when you install the PC system.
6. This motherboard supports ASRock AM2 Boost overclocking technology. If you enable this function in the BIOS setup, the memory performance will improve up to 12.5%, but the effect still depends on the AM2 CPU you adopt. Enabling this function will overclock the chipset/CPU reference clock. However, we can not guarantee the system stability for all CPU/DRAM configurations. If your system is unstable after AM2 Boost function is enabled, it may not be applicative to your system. You may choose to disable this function for keeping the stability of your system.
7. Please remove PCIE Switch card from PCIE2/PCIE SWITCH slot before you use ATI™ CrossFire™ function. In CrossFire™ mode, the two ATI™ graphics cards you install should be from the same GPU family.
8. This motherboard is bundled with one PCIE Switch card installed on PCIE2/PCIE SWITCH slot, which allows you better flexibility to choose PCIE functions between one PCIE x16 slot and two PCIE slots for ATI™ CrossFire™ without setting up jumpers. To avail of the PCI Express x16 graphics card installed on PCIE3 slot work at PCIE x16 bandwidth, please make sure that PCIE Switch card is installed on PCIE2/PCIE SWITCH slot. Please refer to page 18 for details of installing a single graphics card.
9. For microphone input, this motherboard supports both stereo and mono modes. For audio output, this motherboard supports 2-channel, 4-channel, 6-channel, and 8-channel modes. Please check the table on page 11 for proper connection.
10. Before installing SATAII hard disk to SATAII connector, please read the "SATAII Hard Disk Setup Guide" on page 33 to adjust your SATAII hard disk drive to SATAII mode. You can also connect SATA hard disk to SATAII connector directly.

-
11. This motherboard supports eSATAII interface, the external SATAII specification. Please read "eSATAII Interface Introduction" on page 30 for details about eSATAII and eSATAII installation procedures.
 12. Power Management for USB 2.0 works fine under Microsoft® Windows® Vista™ / XP 64-bit / XP SP1 or SP2 / 2000 SP4.
 13. Microsoft® Windows® Vista™ driver is not ready yet. We will update it to our website in the future. Please visit our website for Microsoft® Windows® Vista™ driver and related information.
ASRock website <http://www.asrock.com>

1.3 Minimum Hardware Requirement Table for Windows® Vista™ Premium and Basic Logo

For system integrators and users who purchase this motherboard and plan to submit Windows® Vista™ Premium and Basic logo, please follow the below table for minimum hardware requirement. Please adopt the CPU, memory, and VGA that we suggest.

CPU	Sempron 2800+
Memory	512MB Single Channel
VGA	DX9.0 with WDDM Driver
	with 128bit VGA memory (Premium)
	with 64bit VGA memory (Basic)

1.5 ASRock 8CH_eSATAII I/O

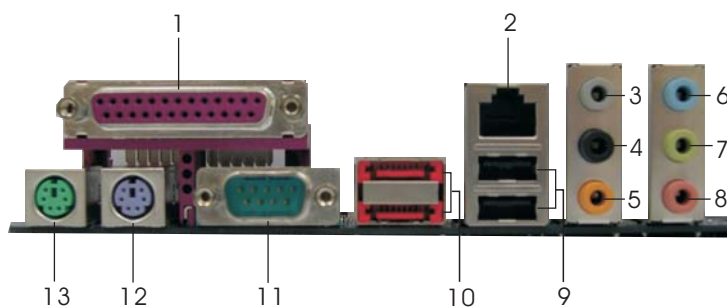

- | | |
|---------------------------|--------------------------------|
| 1 Parallel Port | 8 Microphone (Pink) |
| 2 RJ-45 Port | 9 USB 2.0 Ports (USB01) |
| 3 Side Speaker (Gray) | 10 eSATAII Ports |
| 4 Rear Speaker (Black) | 11 COM Port |
| 5 Central / Bass (Orange) | 12 PS/2 Keyboard Port (Purple) |
| 6 Line In (Light Blue) | 13 PS/2 Mouse Port (Green) |
| *7 Front Speaker (Lime) | |

* If you use 2-channel speaker, please connect the speaker's plug into "Front Speaker Jack". See the table below for connection details in accordance with the type of speaker you use.

TABLE for Audio Output Connection

Audio Output Channels	Front Speaker (No. 7)	Rear Speaker (No. 4)	Central / Bass (No. 5)	Side Speaker (No. 3)
2	V	--	--	--
4	V	V	--	--
6	V	V	V	--
8	V	V	V	V

* To enable Multi-Streaming function, you need to connect a front panel audio cable to the front panel audio header. After restarting your computer, you will find "Mixer" tool on your system. Please select "Mixer ToolBox" , click "Enable playback multi-streaming", and click "ok". Choose "2CH", "4CH", "6CH", or "8CH" and then you are allowed to select "Realtek HDA Primary output" to use Rear Speaker, Central/Bass, and Front Speaker, or select "Realtek HDA Audio 2nd output" to use front panel audio.

2. Installation

This is an ATX form factor (12.0-in x 8.2-in, 30.5 cm x 20.8 cm) motherboard. Before you install the motherboard, study the configuration of your chassis to ensure that the motherboard fits into it.

Pre-installation Precautions

Take note of the following precautions before you install motherboard components or change any motherboard settings.



Before you install or remove any component, ensure that the power is switched off or the power cord is detached from the power supply. Failure to do so may cause severe damage to the motherboard, peripherals, and/or components.

1. Unplug the power cord from the wall socket before touching any component.
2. To avoid damaging the motherboard components due to static electricity, NEVER place your motherboard directly on the carpet or the like. Also remember to use a grounded wrist strap or touch a safety grounded object before you handle components.
3. Hold components by the edges and do not touch the ICs.
4. Whenever you uninstall any component, place it on a grounded anti-static pad or in the bag that comes with the component.
5. When placing screws into the screw holes to secure the motherboard to the chassis, please do not over-tighten the screws! Doing so may damage the motherboard.

2.1 CPU Installation

- Step 1. Unlock the socket by lifting the lever up to a 90° angle.
- Step 2. Position the CPU directly above the socket such that the CPU corner with the golden triangle matches the socket corner with a small triangle.
- Step 3. Carefully insert the CPU into the socket until it fits in place.



The CPU fits only in one correct orientation. DO NOT force the CPU into the socket to avoid bending of the pins.

- Step 4. When the CPU is in place, press it firmly on the socket while you push down the socket lever to secure the CPU. The lever clicks on the side tab to indicate that it is locked.



STEP 1:
Lift Up The Socket Lever

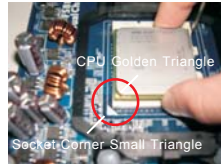

STEP 2 / STEP 3:
Match The CPU Golden Triangle
To The Socket Corner Small
Triangle



STEP 4:
Push Down And Lock
The Socket Lever

2.2 Installation of CPU Fan and Heatsink

After you install the CPU into this motherboard, it is necessary to install a larger heatsink and cooling fan to dissipate heat. You also need to spray thermal grease between the CPU and the heatsink to improve heat dissipation. Make sure that the CPU and the heatsink are securely fastened and in good contact with each other. Then connect the CPU fan to the CPU FAN connector (CPU_FAN1, see Page 10, No. 3). For proper installation, please kindly refer to the instruction manuals of the CPU fan and the heatsink.

2.3 Installation of Memory Modules (DIMM)

This motherboard provides four 240-pin DDRII (Double Data Rate II) DIMM slots, and supports Dual Channel Memory Technology. For dual channel configuration, you always need to install **identical** (the same brand, speed, size and chip-type) DDRII DIMM pair in the slots of the same color. In other words, you have to install **identical** DDRII DIMM pair in **Dual Channel A** (DDRII_1 and DDRII_2; Yellow slots; see p.10 No.7) or **identical** DDRII DIMM pair in **Dual Channel B** (DDRII_3 and DDRII_4; Orange slots; see p.10 No.8), so that Dual Channel Memory Technology can be activated. This motherboard also allows you to install four DDRII DIMMs for dual channel configuration, and please install **identical** DDRII DIMMs in all four slots. You may refer to the Dual Channel Memory Configuration Table below.

Dual Channel Memory Configurations

	DDRII_1 (Yellow Slot)	DDRII_2 (Yellow Slot)	DDRII_3 (Orange Slot)	DDRII_4 (Orange Slot)
(1)	Populated	Populated	-	-
(2)	-	-	Populated	Populated
(3)*	Populated	Populated	Populated	Populated

* For the configuration (3), please install **identical** DDRII DIMMs in all four slots.



1. If you want to install two memory modules, for optimal compatibility and reliability, it is recommended to install them in the slots of the same color. In other words, install them either in the set of yellow slots (DDRII_1 and DDRII_2), or in the set of orange slots (DDRII_3 and DDRII_4).
2. If only one memory module or three memory modules are installed in the DDRII DIMM slots on this motherboard, it is unable to activate the Dual Channel Memory Technology.
3. If a pair of memory modules is NOT installed in the same Dual Channel, for example, installing a pair of memory modules in DDRII_1 and DDRII_3, it is unable to activate the Dual Channel Memory Technology .
4. It is not allowed to install a DDR memory module into DDRII slot; otherwise, this motherboard and DIMM may be damaged.

Installing a DIMM



Please make sure to disconnect power supply before adding or removing DIMMs or the system components.

- Step 1. Unlock a DIMM slot by pressing the retaining clips outward.
Step 2. Align a DIMM on the slot such that the notch on the DIMM matches the break on the slot.

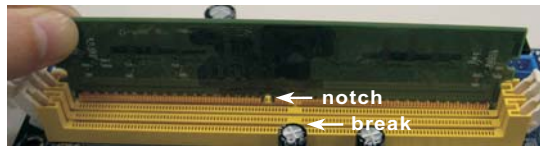
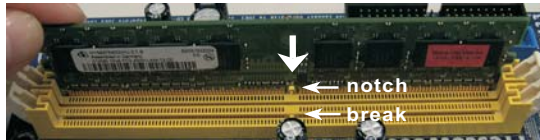

The DIMM only fits in one correct orientation. It will cause permanent damage to the motherboard and the DIMM if you force the DIMM into the slot at incorrect orientation.

- Step 3. Firmly insert the DIMM into the slot until the retaining clips at both ends fully snap back in place and the DIMM is properly seated.

2.4 Expansion Slots (PCI and PCI Express Slots)

There are 3 PCI slots and 3 PCI Express slots on this motherboard.

PCI slots: PCI slots are used to install expansion cards that have the 32-bit PCI interface.

PCIE Slots: PCIE1 slot (PCI Express x1 slot) is used for PCI Express cards with x1 lane width, such as Gigabit LAN card, SATA2 card, etc.

For PCIE2/PCIE SWITCH slot and PCIE3 slot, you may choose to use one PCI Express x16 slot with PCIE Switch card or two PCI Express Graphics slots for ATI™ CrossFire™.

NOTE:

If you want the PCI Express x16 graphics card on PCIE3 slot to work at PCIE x16 bandwidth, you need to install PCIE Switch card on PCIE2/PCIE SWITCH slot. Please refer to page 18 for details of installing a single graphics card.

If you want to enable ATI™ CrossFire™ feature, please refer to page 19 for details of installing CrossFire™ graphics cards.

Please refer to the table below for possible PCIE2/PCIE SWITCH slot and PCIE3 slot configurations.

PCIE2/PCIE Switch Slot and PCIE3 Slot Configurations

	PCIE2/PCIE SWITCH Slot	PCIE3 Slot
	Card Type	Card Type
Single Graphics Card *	PCIE Switch Card	PCIE x16 graphics card
Dual Graphics Cards in CrossFire™ Mode **	ATI™ Standard Radeon (CrossFire™ Ready) graphics card	ATI™ Radeon CrossFire™ Edition graphics card

* To avail of the PCI Express x16 graphics card installed on PCIE3 slot work at PCIE x16 bandwidth, please make sure that PCIE Switch card is installed on PCIE2/PCIE SWITCH slot. Please refer to page 18 for details of installing a single graphics card.

** Please remove PCIE Switch card from PCIE2/PCIE SWITCH slot before you use ATI™ CrossFire™ function. In CrossFire™ mode, the two ATI™ graphics cards you install should be from the same GPU family.

Installing an expansion card

- Step 1. Before installing the expansion card, please make sure that the power supply is switched off or the power cord is unplugged. Please read the documentation of the expansion card and make necessary hardware settings for the card before you start the installation.
- Step 2. Remove the system unit cover (if your motherboard is already installed in a chassis).
- Step 3. Remove the bracket facing the slot that you intend to use. Keep the screws for later use.
- Step 4. Align the card connector with the slot and press firmly until the card is completely seated on the slot.
- Step 5. Fasten the card to the chassis with screws.
- Step 6. Replace the system cover.

2.5 Installing a Single Graphics Card

- Step 1. Install a PCI Express x16 graphics card on PCIE3 slot. Please refer to page 17 for proper procedures of installing an expansion card.
- Step 2. Make sure that the PCIE Switch card is installed on PCIE2/PCIE SWITCH slot to avail of the PCI Express x16 graphics card full x16 bandwidth.



PCIE Switch card

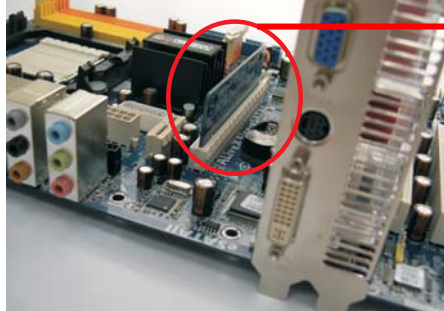

PCIE Switch card
on PCIE2/PCIE
SWITCH slot

- Step 3. Connect one end of the monitor cable to the PCI Express x16 graphics card on PCIE3 slot.
- Step 4. Connect another end of the monitor cable to the corresponding port on your monitor.
- Step 5. Connect an auxiliary power source from the power supply to the PCI Express x16 graphics card on PCIE3 slot. (Only when your graphics card provides such a power connector.)

2.6 Installing CrossFire™ Graphics Cards

This motherboard supports CrossFire™ feature. CrossFire™ technology offers the most advantageous means available of combining multiple high performance Graphics Processing Units (GPU) in a single PC. Combining a range of different operating modes with intelligent software design and an innovative interconnect mechanism, CrossFire™ enables the highest possible level of performance and image quality in any 3D application. Currently CrossFire™ feature is only supported with Windows® XP with Service Pack 2; it may be supported with other OS in the future, such as Windows® Vista™. Please check ATI™ website for driver updates.



What graphics cards work with CrossFire™?

A complete CrossFire™ system requires a CrossFire™ Ready motherboard, a CrossFire™ Edition graphics card and a compatible standard Radeon (CrossFire™ Ready) graphics card from the same series, or two CrossFire™ Ready cards if they are software enabled. This applies to cards from ATI™ or any of its partners.

Cards For PCIE2/PCIE SWITCH Slot	Cards For PCIE3 Slot
Radeon X1950 Series	Radeon X1950 CrossFire™ Edition
Radeon X1900 Series	Radeon X1900 CrossFire™ Edition
Radeon X1800 Series	Radeon X1800 CrossFire™ Edition
Radeon X1600 Series	Radeon X1600 Series
Radeon X1300 Series	Radeon X1300 Series
Radeon X850 Series	Radeon X850 CrossFire™ Edition



1. If a customer incorrectly configures their system they will not see the performance benefits of CrossFire™. All three CrossFire™ components, a CrossFire™ Ready graphics card, a CrossFire™ Ready motherboard and a CrossFire™ Edition co-processor graphics card, must be installed correctly to benefit from the CrossFire™ multi-GPU platform.
2. If you pair a 12-pipe CrossFire™ Edition card with a 16-pipe card, both cards will operate as 12-pipe cards while in CrossFire™ mode.

Enjoy the benefit of CrossFire™



Currently, ATI™ has released Radeon X850XT, X1800XT, X1900XT, X1950XT, X1300, and X1600 CrossFire™ cards, which require different methods to enable CrossFire™ feature. In the below procedures, we use Radeon X850XT as the example graphics card. For other CrossFire™ cards that ATI™ has released or will release in the future, please refer to ATI™ graphics card manuals for detailed installation guide.

- Step 1. Remove PCIE Switch card from PCIE2/PCIE SWITCH slot if one is installed.
- Step 2. Connect to the system power supply. Please connect a hard disk power connector to SLI/XFIRE Power connector on this motherboard.



It is recommended to use 500-Watt power supply or greater to perform the benefit of CrossFire™ feature for Radeon X850XT, X1900 and X1950 series.



Step 3. Install the standard Radeon (CrossFire™ Ready) graphics card to PCIE2/ PCIE SWITCH slot. For the proper installation procedures, please refer to section “Expansion Slots”.

Standard Radeon (CrossFire™ Ready) graphics card



Step 4. Install the Radeon CrossFire™ Edition graphics card to PCIE3 slot. For the proper installation procedures, please refer to section “Expansion Slots”.

Standard Radeon (CrossFire™ Ready) graphics card

Radeon CrossFire™ Edition graphics card

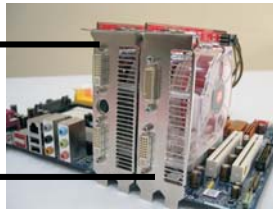

1. You are allowed to install two CrossFire™ Edition graphics cards to both slots, or you may use one CrossFire™ Edition graphics cards and a compatible standard Radeon (CrossFire™ Ready) graphics card from the same series.
2. For ATI™ Radeon X1300 and X1600 series, there are no CrossFire™ Edition graphics cards. You can still install two regular graphics cards from the same series (two Radeon X1300 series cards or two Radeon X1600 series cards) on PCIE2/PCIE SWITCH slot and PCIE3 slot to support CrossFire™. Besides, please connect the monitor cable to the graphics card on PCIE3 slot.

Step 5. Correctly connect the DVI-DMS cable to the monitor connector and two graphics cards that you install. (If you install two standard Radeon (CrossFire™ Ready) graphics cards to this motherboard, please skip this step.)



DVI-DMS cable



DMS connector



DVI connector

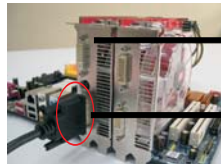

Standard Radeon (CrossFire™ Ready) graphics card

DVI connector

Connect the DVI-DMS cable to DVI connector of the compatible standard Radeon (CrossFire™ Ready) graphics card.



There are two DVI connectors on the standard Radeon (CrossFire™ Ready) graphics card. Please connect the DVI-DMS cable to the correct DVI connector; otherwise, the graphics card will not work.

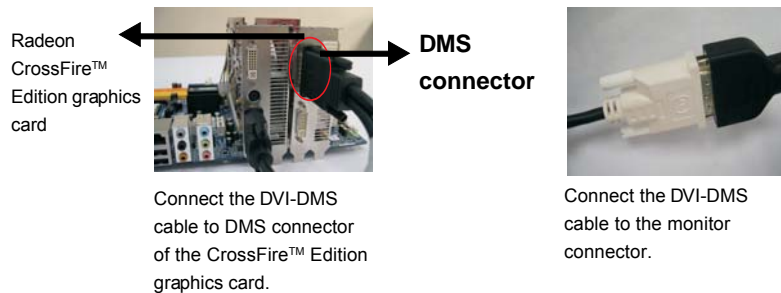

If you install two CrossFire™ Edition graphics cards to this motherboard, please connect one end of DVI-DMS cable to the monitor, another end to DMS of one of the CrossFire™ Edition graphics cards to PCIE3 slot, and the other end to DVI of another CrossFire™ Edition graphics card to PCIE2/PCIE SWITCH slot. If you install one CrossFire™ Edition graphics card and one compatible standard Radeon (CrossFire™ Ready) graphics card to this motherboard, please connect one end of DVI-DMS cable to the monitor, another end to DMS of the CrossFire™ Edition graphics card, and the other end to DVI of the compatible standard Radeon (CrossFire™ Ready) graphics card.

- Step 6. Power on your computer and boot into OS.
- Step 7. Remove the ATI™ driver if you have any VGA driver installed in your system.



The Catalyst Uninstaller is an optional download. We recommend using this utility to uninstall any previously installed Catalyst drivers prior to installation. Please visit this website for the driver:
<http://support.ati.com/ics/support/DLRedirect.asp?fileIDExt=050553d40196ef109fff37cbb40aaf28&accountID=737&deptID=894>

- Step 8. Install the required drivers to your system. Please visit the websites below for installing the drivers that ATI™ recommends:
- A. ATI™ recommends Windows® XP Service Pack 2 or higher to be installed (If you have Windows® XP Service Pack 2 or higher installed in your system, there is no need to download it again):
<http://www.microsoft.com/windowsxp/sp2/default.msp>
 - B. You must have Microsoft .NET Framework installed prior to downloading and installing the CATALYST Control Center:
<http://www.microsoft.com/downloads/details.aspx?FamilyId=262D25E3-F589-4842-8157-034D1E7CF3A3&displaylang=en>
- Step 9. Restart your computer.

Step 10. Install the VGA card drivers to your system, and restart your computer. Then you will find "ATI Catalyst Control Center" on your desktop.

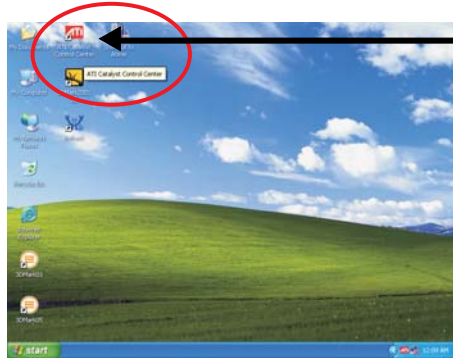

You will find "ATI Catalyst Control Center" on your desktop.

Step 11. Double-click "ATI Catalyst Control Center". Click "View", and select "Advanced View". Click "CrossFire™", and then set the option "Enable CrossFire™" to "Yes".

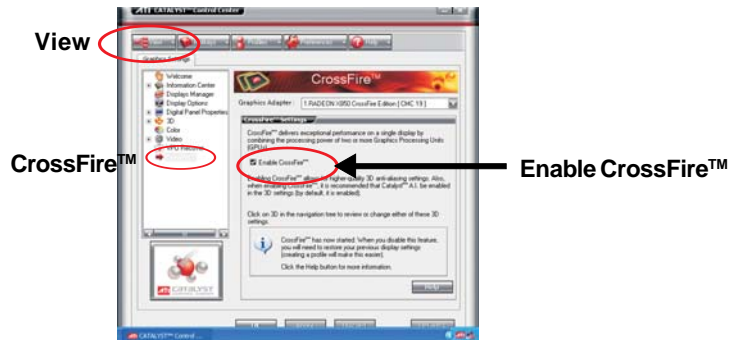

If you install one Radeon CrossFire™ Edition graphics card and one compatible standard Radeon (CrossFire™ Ready) graphics card to this motherboard but not two Radeon CrossFire™ Edition graphics cards, please as well follow the above steps. However, although you have selected the option "Enable CrossFire™", the CrossFire™ function can not work actually. Your computer will automatically reboot. After restarting your computer, please confirm whether the option "Enable CrossFire™" in "ATI Catalyst Control Center" is selected or not; if not, please select it again, and then you are able to enjoy the benefit of CrossFire™ feature.

Step 12. You can freely enjoy the benefit of CrossFire™ feature.

* **CrossFire™** appearing here is a registered trademark of ATI™ Technologies Inc., and is used only for identification or explanation and to the owners' benefit, without intent to infringe.

2.7 Surround Display Feature

This motherboard supports Surround Display upgrade. With the external add-on PCI Express VGA cards, you can easily enjoy the benefits of Surround Display feature. For the detailed instruction, please refer to the document at the following path in the Support CD:

..\ Surround Display Information

2.8 Jumpers Setup

The illustration shows how jumpers are setup. When the jumper cap is placed on pins, the jumper is "Short". If no jumper cap is placed on pins, the jumper is "Open". The illustration shows a 3-pin jumper whose pin1 and pin2 are "Short" when jumper cap is placed on these 2 pins.

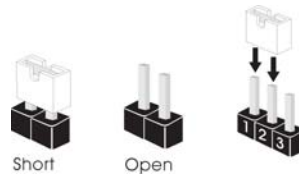

Jumper	Setting	
PS2_USB_PW1 (see p.10, No. 1)		Short pin2, pin3 to enable +5VSB (standby) for PS/2 or USB wake up events.

Note: To select +5VSB, it requires 2 Amp and higher standby current provided by power supply.

Clear CMOS Jumper (CLR CMOS1) (see p.10, No. 11)	
--------------------------------------------------------	--

Note: CLR CMOS1 allows you to clear the data in CMOS. The data in CMOS includes system setup information such as system password, date, time, and system setup parameters. To clear and reset the system parameters to default setup, please turn off the computer and unplug the power cord from the power supply. After waiting for 15 seconds, use a jumper cap to short pin2 and pin3 on CLR CMOS1 for 5 seconds. However, please do not clear the CMOS right after you update the BIOS. If you need to clear the CMOS when you just finish updating the BIOS, you must boot up the system first, and then shut it down before you do the clear-CMOS action.

2.9 Onboard Headers and Connectors



Onboard headers and connectors are NOT jumpers. Do NOT place jumper caps over these headers and connectors. Placing jumper caps over the headers and connectors will cause permanent damage of the motherboard!

Floppy Connector

(33-pin FLOPPY1)
(see p.10 No. 25)



Note: Make sure the red-striped side of the cable is plugged into Pin1 side of the connector.

Primary IDE connector (Blue)

(39-pin IDE1, see p.10 No. 9)



Note: Please refer to the instruction of your IDE device vendor for the details.

Serial ATAII Connectors

(SATAII_BLUE (PORT 4):
see p.10, No. 21)
(SATAII_BLACK (PORT 3):
see p.10, No. 16)
(SATAII_RED (PORT 1):
see p.10, No. 15)
(SATAII_ORANGE (PORT 2):
see p.10, No. 14)



These four Serial ATAII (SATAII) connectors support SATA data cables for internal storage devices. The current SATAII interface allows up to 3.0 Gb/s data transfer rate.



SATAII_RED (PORT 1) and SATAII_ORANGE (PORT 2) connectors can be used for internal storage devices or be connected to eSATAII_BOTTOM and eSATAII_TOP connectors with corresponding color to support eSATAII devices. Please read "eSATAII Interface Introduction" on page 30 for details about eSATAII and eSATAII installation procedures.

eSATAII Connectors

(eSATAII_TOP: see p.10, No. 36)
(eSATAII_BOTTOM: see p.10, No. 37)

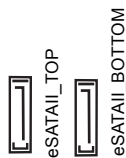

These two eSATAII connectors support SATA data cables for external SATAII function. The current eSATAII interface allows up to 3.0 Gb/s data transfer rate.

Serial ATA (SATA)
Data Cable
(Optional)



Either end of the SATA data cable can be connected to the SATA / SATAII hard disk or the SATAII connector on the motherboard. You can also use the SATA data cable to connect SATAII connectors and eSATAII connectors with corresponding color.

Serial ATA (SATA)
Power Cable
(Optional)

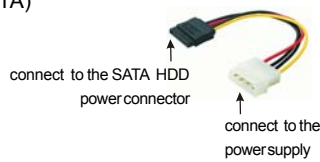

Please connect the black end of SATA power cable to the power connector on each drive. Then connect the white end of SATA power cable to the power connector of the power supply.

USB 2.0 Headers
(9-pin USB8_9)
(see p.10 No. 20)

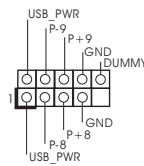

Besides two default USB 2.0 ports on the I/O panel, there are four USB 2.0 headers on this motherboard. Each USB 2.0 header can support two USB 2.0 ports.

(9-pin USB6_7)
(see p.10 No. 19)

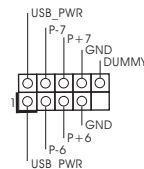

(9-pin USB4_5)
(see p.10 No. 18)

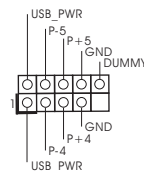

(9-pin USB2_3)
(see p.10 No. 17)

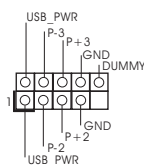

Infrared Module Header

(5-pin IR1)
(see p.10 No. 31)

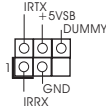

This header supports an optional wireless transmitting and receiving infrared module.

Internal Audio Connectors

(4-pin CD1)
(CD1: see p.10 No. 35)

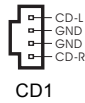

This connector allows you to receive stereo audio input from sound sources such as a CD-ROM, DVD-ROM, TV tuner card, or MPEG card.

Front Panel Audio Header

(9-pin HD_AUDIO1)
(see p.10 No. 27)

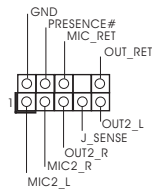

This is an interface for the front panel audio cable that allows convenient connection and control of audio devices.



1. High Definition Audio supports Jack Sensing, but the panel wire on the chassis must support HDA to function correctly. Please follow the instruction in our manual and chassis manual to install your system.
2. If you use AC'97 audio panel, please install it to the front panel audio header as below:
 - A. Connect Mic_IN (MIC) to MIC2_L.
 - B. Connect Audio_R (RIN) to OUT2_R and Audio_L (LIN) to OUT2_L.
 - C. Connect Ground (GND) to Ground (GND).
 - D. MIC_RET and OUT_RET are for HD audio panel only. You don't need to connect them for AC'97 audio panel.
 - E. Enter BIOS Setup Utility. Enter Advanced Settings, and then select Chipset Configuration. Set the Front Panel Control option from [Auto] to [Enabled].
 - F. Enter Windows system. Click the icon on the lower right hand taskbar to enter Realtek HD Audio Manager. Click "Audio I/O", select "Connector Settings" , choose "Disable front panel jack detection", and save the change by clicking "OK".

System Panel Header

(9-pin PANEL1)
(see p.10 No. 23)

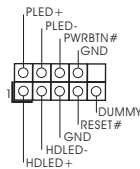

This header accommodates several system front panel functions.

Chassis Speaker Header

(4-pin SPEAKER 1)
(see p.10 No. 24)

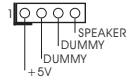

Please connect the chassis speaker to this header.

Chassis Fan Connector

(3-pin CHA_FAN1)
(see p.10 No. 22)

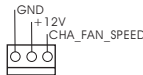

Please connect a chassis fan cable to this connector and match the black wire to the ground pin.

CPU Fan Connector

(4-pin CPU_FAN1)
(see p.10 No. 3)



Please connect the CPU fan cable to this connector and match the black wire to the ground pin.



Though this motherboard provides 4-Pin CPU fan (Quiet Fan) support, the 3-Pin CPU fan still can work successfully even without the fan speed control function. If you plan to connect the 3-Pin CPU fan to the CPU fan connector on this motherboard, please connect it to Pin 1-3.

Pin 1-3 Connected

3-Pin Fan Installation

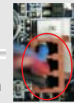

ATX Power Connector

(20-pin ATXPWR1)
(see p.10 No. 4)



Please connect an ATX power supply to this connector.

ATX 12V Power Connector

(4-pin ATX12V1)
(see p.10 No. 2)



Please note that it is necessary to connect a power supply with ATX 12V plug to this connector. Failing to do so will cause power up failure.

SLI/XFIRE Power Connector

(4-pin SLI/XFIRE_POWER1)
(see p.10 No. 34)



SLI/XFIRE_POWER1

It is not necessary to use this connector, but please connect it with a hard disk power connector when two graphics cards are plugged to this motherboard at the same time.

Game Port Header
 (15-pin GAME1)
 (see p.10 No. 26)

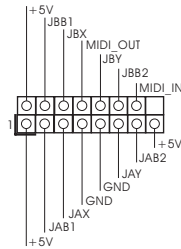

Connect a Game cable to this header if the Game port bracket is installed.

HDMI_SPDIF Header
 (3-pin HDMI_SPDIF1)
 (see p.10 No. 29)



HDMI_SPDIF header, providing SPDIF audio output to HDMI VGA card, allows the system to connect HDMI Digital TV/ projector/LCD devices. Please connect the HDMI_SPDIF connector of HDMI VGA card to this header.

HDMI_SPDIF Cable
 (Optional)

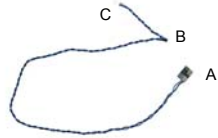

Please connect the black end (A) of HDMI_SPDIF cable to the HDMI_SPDIF header on the motherboard. Then connect the white end (B or C) of HDMI_SPDIF cable to the HDMI_SPDIF connector of HDMI VGA card.

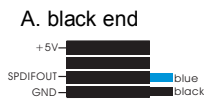

USB Bracket



This USB bracket can support 2 additional USB 2.0 ports besides the I/O panel. Please connect the blue connector on the cable of this USB bracket to the USB 2.0 header (USB2_3, USB4_5, USB6_7 or USB8_9) and fasten the USB bracket to the chassis with screws.

2.10 HDMI_SPDIF Header Connection Guide

HDMI (High-Definition Multi-media Interface) is an all-digital audio/video specification, which provides an interface between any compatible digital audio/video source, such as a set-top box, DVD player, A/V receiver and a compatible digital audio or video monitor, such as a digital television (DTV). A complete HDMI system requires a HDMI VGA card and a HDMI ready motherboard with a HDMI_SPDIF header. This motherboard is equipped with a HDMI_SPDIF header, which provides SPDIF audio output to HDMI VGA card, allows the system to connect HDMI Digital TV/projector/ LCD devices. To use HDMI function on this motherboard, please carefully follow the below steps.

Step 1. Install the HDMI VGA card to the PCI Express Graphics slot on this motherboard. For the proper installation of HDMI VGA card, please refer to the installation guide on page 17 and page 18.

Step 2. Connect the black end (A) of HDMI_SPDIF cable to the HDMI_SPDIF header (HDMI_SPDIF1, yellow, see page 10, No. 29) on the motherboard.



Make sure to correctly connect the HDMI_SPDIF cable to the motherboard and the HDMI VGA card according to the same pin definition. For the pin definition of HDMI_SPDIF header and HDMI_SPDIF cable connectors, please refer to page 28. For the pin definition of HDMI_SPDIF connectors on HDMI VGA card, please refer to the user manual of HDMI VGA card vendor. Incorrect connection may cause permanent damage to this motherboard and the HDMI VGA card.

Step 3. Connect the white end (B or C) of HDMI_SPDIF cable to the HDMI_SPDIF connector of HDMI VGA card. (There are two white ends (2-pin and 3-pin) on HDMI_SPDIF cable. Please choose the appropriate white end according to the HDMI_SPDIF connector of the HDMI VGA card you install.



white end
(2-pin) (B)



white end
(3-pin) (C)



Please do not connect the white end of HDMI_SPDIF cable to the wrong connector of HDMI VGA card or other VGA card. Otherwise, the motherboard and the VGA card may be damaged. For example, this picture shows the wrong example of connecting HDMI_SPDIF cable to the fan connector of PCI Express VGA card. Please refer to the VGA card user manual for connector usage in advance.



Step 4. Connect the HDMI output connector on HDMI VGA card to HDMI device, such as HDTV. Please refer to the user manual of HDTV and HDMI VGA card vendor for detailed connection procedures.



Step 5. Install HDMI VGA card driver to your system.

2.11 eSATAII Interface Introduction

What is eSATAII?

This motherboard supports eSATAII interface, the external SATAII specification. eSATAII allows you to enjoy the SATAII function provided by the I/O of your computer, offering the high speed data transfer rate up to 3.0Gb/s, and the convenient mobility like USB. eSATAII is equipped with Hot Plug capability that enables you to exchange drives easily. For example, with eSATAII interface, you may simply plug your eSATAII hard disk to the eSATAII ports instead of opening your chassis to exchange your SATAII hard disk. Currently, on the market, the data transfer rate of USB 2.0 is up to 480Mb/s, and for IEEE 1394 is up to 400Mb/s. However, eSATAII provides the data transfer rate up to 3000Mb/s, which is much higher than USB 2.0 and IEEE 1394, and still keeps the convenience of Hot Plug feature. Therefore, on the basis of the advantageous transfer speed and the facilitating mobile capability, in the near future, eSATAII will replace USB 2.0 and IEEE 1394 to be a trend for external interface.

NOTE:

1. If you set "SATA Operation Mode" option in BIOS setup to AHCI or RAID mode, Hot Plug function is supported with eSATAII devices. Therefore, you can insert or remove your eSATAII devices to the eSATAII ports while the system is power-on and in working condition.
2. If you set "SATA Operation Mode" option in BIOS setup to non-RAID mode, Hot Plug function is not supported with eSATAII devices. If you still want to use eSATAII function in non-RAID mode, please insert or remove your eSATAII devices to the eSATAII ports only when the system is power-off.
3. Please refer to page 36 to 39 for detailed information of RAID mode, non-RAID mode, and AHCI mode.

How to install eSATAII?



SATAII_RED (PORT 1)
and SATAII_ORANGE (PORT 2)



eSATAII_TOP and
eSATAII_BOTTOM

1. If you just plan to install one eSATAII device to this motherboard, it is recommended to enable the bottom eSATAII port of the I/O shield. In order to enable the bottom eSATAII port of the I/O shield, you need to connect the red SATAII connector (SATAII_RED (PORT 1); see p.10 No.15) and the red eSATAII connector (eSATAII_BOTTOM; see p.10 No.37) with a SATA data cable first. Then the bottom eSATAII port of the I/O shield is enabled.



Connect the SATA data cable to the red SATAII connector (SATAII_RED (PORT 1))



Connect the SATA data cable to the red eSATAII connector (eSATAII_BOTTOM)



2. If you plan to install two eSATAII devices to this motherboard, you need to enable both the top and the bottom eSATAII ports of the I/O shield. In order to enable the top and the bottom eSATAII ports of the I/O shield, you have to connect the red SATAII connector (SATAII_RED (PORT 1); see p.10 No.15) and the red eSATAII connector (eSATAII_BOTTOM; see p.10 No.37) with a SATA data cable first, and then connect the orange SATAII connector (SATAII_ORANGE (PORT 2); see p.10 No.14) and the orange eSATAII connector (eSATAII_TOP; see p.10 No.36) with another SATA data cable. After that, both the top and the bottom eSATAII ports of the I/O shield are enabled.



Connect the SATA data cables to both red SATAII connector (SATAII_RED (PORT 1)) and orange SATAII connector (SATAII_ORANGE (PORT 2))



Connect the SATA data cables to both red eSATAII connector (eSATAII_BOTTOM) and orange eSATAII connector (eSATAII_TOP)



Please make sure to correctly connect the SATAII and eSATAII connectors with corresponding color so that the eSATAII function will work successfully.

- Use the eSATAII device cable to connect eSATAII device and the eSATAII port of the I/O shield according to the eSATAII connector that you connect the SATA data cable.

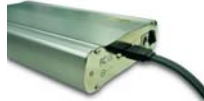

Connect one end of the eSATAII device cable to eSATAII device



Connect the other end of the eSATAII device cable to eSATAII port of the I/O shield

Comparison between eSATAII and other devices

IEEE 1394	400Mb/s
USB 2.0	480Mb/s
SATA	1.5Gb/s (1500Mb/s)
eSATAII/SATAII	3.0Gb/s (3000Mb/s)

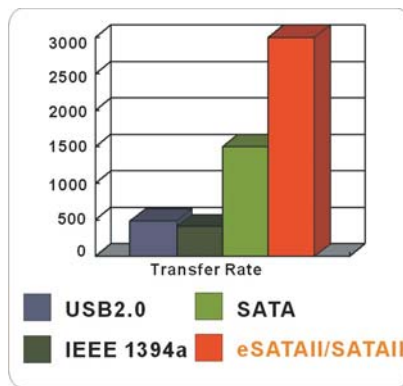

2.12 SATAII Hard Disk Setup Guide

Before installing SATAII hard disk to your computer, please carefully read below SATAII hard disk setup guide. Some default setting of SATAII hard disks may not be at SATAII mode, which operate with the best performance. In order to enable SATAII function, please follow the below instruction with different vendors to correctly adjust your SATAII hard disk to SATAII mode in advance; otherwise, your SATAII hard disk may fail to run at SATAII mode.

Western Digital

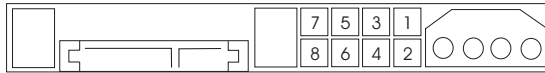

If pin 5 and pin 6 are shorted, SATA 1.5Gb/s will be enabled.

On the other hand, if you want to enable SATAII 3.0Gb/s, please remove the jumpers from pin 5 and pin 6.

SAMSUNG

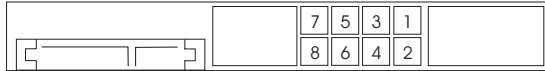

If pin 3 and pin 4 are shorted, SATA 1.5Gb/s will be enabled.

On the other hand, if you want to enable SATAII 3.0Gb/s, please remove the jumpers from pin 3 and pin 4.

HITACHI

Please use the Feature Tool, a DOS-bootable tool, for changing various ATA features. Please visit HITACHI's website for details:

<http://www.hitachigst.com/hdd/support/download.htm>



The above examples are just for your reference. For different SATAII hard disk products of different vendors, the jumper pin setting methods may not be the same. Please visit the vendors' website for the updates.

2.13 Serial ATA (SATA) / Serial ATAII (SATAII) Hard Disks Installation

This motherboard adopts ATI™ SB600 south bridge chipset that supports Serial ATA (SATA) / Serial ATAII (SATAII) hard disks and RAID (RAID 0, RAID 1, and RAID 10) functions. You may install SATA / SATAII hard disks on this motherboard for internal storage devices. This section will guide you to install the SATA / SATAII hard disks.

- STEP 1: Install the SATA / SATAII hard disks into the drive bays of your chassis.
- STEP 2: Connect the SATA power cable to the SATA / SATAII hard disk.
- STEP 3: Connect one end of the SATA data cable to the motherboard's SATAII connector.
- STEP 4: Connect the other end of the SATA data cable to the SATA / SATAII hard disk.



1. If you plan to use RAID 0 or RAID 1 function, you need to install at least 2 SATA / SATAII hard disks. If you plan to use RAID 10 function, you need to install 4 SATA / SATAII hard disks.
2. It is recommended to build RAID 0, RAID 1 or RAID 10 on internal SATA/ SATAII ports. In other words, if SATAII_RED (PORT 1) and SATAII_ORANGE (PORT 2) are used for eSATAII ports, please build RAID on SATAII_BLUE (PORT 4) and SATAII_BLACK (PORT 3).
3. For OS installation on SATA / SATAII HDDs, please refer to page 36 to 39 for details. If you install a new SATA / SATAII HDD just for data storage purpose, and your SATA / SATAII mode is in RAID or AHCI mode, this empty SATA / SATAII HDD information will not appear in "Disk Management". You need to enter WebPAM to create JBOD first, which means, after you enter WebPAM, please click "Logical Drive View" → "Create" → "JBOD". After that, you can find the empty SATA / SATAII HDDs information in "Disk Management" and start to use it. (WebPAM is an utility for ATI™ Windows RAID. Please refer to RAID Installation Guide in our support CD for detailed operation procedures.)

2.14 Hot Plug and Hot Swap Functions for SATA / SATAII HDDs and eSATAII Devices

This motherboard supports Hot Plug and Hot Swap functions for SATA / SATAII / eSATAII Devices in RAID / AHCI mode. ATI™ SB600 south bridge chipset provides hardware support for Advanced Host controller Interface (AHCI), a new programming interface for SATA host controllers developed thru a joint industry effort. AHCI also provides usability enhancements such as Hot Plug.



NOTE

What is Hot Plug Function?

If the SATA / SATAII HDDs are NOT set for RAID configuration, it is called "Hot Plug" for the action to insert and remove the SATA / SATAII HDDs while the system is still power-on and in working condition.

However, please note that it cannot perform Hot Plug if the OS has been installed into the SATA / SATAII HDD.

What is Hot Swap Function?

If SATA / SATAII HDDs are built as RAID1 then it is called "Hot Swap" for the action to insert and remove the SATA / SATAII HDDs while the system is still power-on and in working condition.

eSATAII is equipped with Hot Plug capability that enables you to exchange drives easily. For example, with eSATAII interface, you may simply plug your eSATAII devices to the eSATAII ports instead of opening your chassis to exchange your SATAII hard disk.

2.15 Driver Installation Guide

To install the drivers to your system, please insert the support CD to your optical drive first. Then, the drivers compatible to your system can be auto-detected and listed on the support CD driver page. Please follow the order from up to bottom side to install those required drivers. Therefore, the drivers you install can work properly.

2.16 Installing Windows® 2000 / Windows® XP / Windows® XP 64-bit / Windows® Vista™ With RAID Functions

If you want to install Windows® 2000, Windows® XP or Windows® XP 64-bit on a RAID disk composed of 2 or more SATA / SATAII HDDs with RAID functions, please follow the below steps.



1. RAID functions are still not available for Windows® Vista™ users now. If you install Windows® Vista™ and want to use RAID functions, please visit our website for the updates of Windows® Vista™ driver and related information in the future.
2. Before installing Windows® 2000 to your system, your CD is supposed to include SP4. If there is no SP4 included in your disk, please visit the below website for proper procedures of making a SP4 disk:
http://www.microsoft.com/Windows2000/downloads/servicepacks/sp4/spdeploy.htm#the_integrated_installation_fmayer

STEP 1: Set up BIOS.

- A. Enter BIOS SETUP UTILITY → Advanced screen → IDE Configuration.
- B. Set the "SATA Operation Mode" option to [RAID].

STEP 2: Make a SATA / SATAII Driver Diskette.

- A. Insert the ASRock Support CD into your optical drive to boot your system.
- B. During POST at the beginning of system boot-up, press <F11> key, and then a window for boot devices selection appears. Please select CD-ROM as the boot device.
- C. When you see the message on the screen, "Generate Serial ATA driver diskette [YN]?", press <Y>.
- D. Then you will see these messages,
**Please insert a blank
formatted diskette into floppy
drive A:
press any key to start**
Please insert a floppy diskette into the floppy drive, and press any key.
- E. The system will start to format the floppy diskette and copy SATA / SATAII drivers into the floppy diskette.

STEP 3: Use "RAID Installation Guide" to set RAID configuration.

Before you start to configure RAID function, you need to check the RAID installation guide in the Support CD for proper configuration. Please refer to the BIOS RAID installation guide part of the document in the following path in the Support CD:

.. \ RAID Installation Guide

STEP 4: Install Windows® 2000 / Windows® XP / Windows® XP 64-bit OS on your system.

After step 1, 2, 3, you can start to install Windows® 2000 / Windows® XP / Windows® XP 64-bit OS on your system. At the beginning of Windows® setup, press F6 to install a third-party RAID driver. When prompted, insert the SATA / SATAII driver diskette containing the ATI™ RAID driver. After reading the floppy disk, the driver will be presented. Select the driver to install according to the OS you install. (Select “ATI AHCI Compatible RAID Controller-x86 platform” for Windows® 2000 and Windows® XP, or “ATI AHCI Compatible RAID Controller-x64 platform” for Windows® XP 64-bit.)

NOTE1. If you install Windows® 2000 / Windows® XP / Windows® XP 64-bit on IDE HDDs and want to manage (create, convert, delete, or rebuild) RAID functions on SATA / SATAII HDDs, you still need to set up “SATA Operation Mode” to [RAID] first. Then, please set the RAID configuration by using the Windows RAID installation guide part of the document in the following path in the Support CD:

.. \ RAID Installation Guide

NOTE2. If your operating system is Windows® 2000, please install the graphics card driver before you install “SATA2 Utility” from our support CD to your system.

2.17 Installing Windows® 2000 / Windows® XP / Windows® XP 64-bit / Windows® Vista™ Without RAID Functions

If you want to install Windows® 2000, Windows® XP, Windows® XP 64-bit or Windows® Vista™ OS on your SATA / SATAII HDDs and eSATAII devices without RAID functions, Please follow the below procedures according to the OS you install.



Before installing Windows® 2000 to your system, your CD is supposed to include SP4. If there is no SP4 included in your disk, please visit the below website for proper procedures of making a SP4 disk:

http://www.microsoft.com/Windows2000/downloads/servicepacks/sp4/spdeploy.htm#the_integrated_installation_fmay

2.17.1 Installing Windows® 2000 / Windows® XP / Windows® XP 64-bit Without RAID Functions

NOTE1. If you install single or multiple SATA / SATAII HDDs on this motherboard and plan to install Windows® 2000 / XP / XP 64-bit on SATA / SATAII HDDs, it is still suggested to use RAID mode even you don't plan to use RAID functions. Please follow the steps of “Using SATA / SATAII HDDs and eSATAII devices with NCQ and Hot Plug functions” below.

NOTE2. AHCI mode is only recommended for Windows® Vista™ users. If you install Windows® 2000 / XP / XP 64-bit, it is not suggested to use AHCI mode.

Using SATA / SATAII HDDs and eSATAII devices with NCQ and Hot Plug functions

STEP 1: Set Up BIOS.

- A. Enter BIOS SETUP UTILITY → Advanced screen → IDE Configuration.
- B. Set the "SATA Operation Mode" option to [RAID].

STEP 2: Make a SATA / SATAII driver diskette.

Make a SATA / SATAII driver diskette by following section 2.16 step 2 on page 36.

STEP 3: Enter BIOS RAID utility (FastBuild Utility) to create JBOD on SATA / SATAII HDD.

Restart your system. Press <Ctrl+F> to enter BIOS RAID utility (FastBuild Utility) to create JBOD on SATA / SATAII HDD. For the proper operating procedures of creating JBOD, please refer to the BIOS RAID installation guide part of the document in the following path in the Support CD:

.. \ RAID Installation Guide



1. JBOD function on this motherboard is only supported with single SATA / SATAII HDD.
2. If you want to enable Hot Plug function on eSATAII ports but you install OS on IDE HDD, please skip step 2 and step 3.

STEP 4: Install Windows® 2000 / Windows® XP / Windows® XP 64-bit OS on your system.

After step 1, 2, 3, you can start to install Windows® 2000 / Windows® XP / Windows® XP 64-bit OS on your system. At the beginning of Windows® setup, press F6 to install a third-party RAID driver. When prompted, insert the SATA / SATAII driver diskette containing the ATI™ RAID driver. After reading the floppy disk, the driver will be presented. Select the driver to install according to the OS you install. (Select "ATI AHCI Compatible RAID Controller-x86 platform" for Windows® 2000 and Windows® XP, or "ATI AHCI Compatible RAID Controller-x64 platform" for Windows® XP 64-bit.)

Using SATA / SATAII HDDs and eSATAII devices without NCQ and Hot Plug functions

STEP 1: Set up BIOS.

- A. Enter BIOS SETUP UTILITY → Advanced screen → IDE Configuration.
- B. Set the "SATA Operation Mode" option to [non-RAID].

STEP 2: Install Windows® 2000 / Windows® XP / Windows® XP 64-bit OS on your system.

2.17.2 Installing Windows® Vista™ Without RAID Functions

Using SATA / SATAII HDDs and eSATAII devices with NCQ and Hot Plug functions

STEP 1: Set Up BIOS.

- A. Enter BIOS SETUP UTILITY → Advanced screen → IDE Configuration.
- B. Set the “SATA Operation Mode” option to [AHCI].

STEP 2: Install Windows® Vista™ OS on your system.

Using SATA / SATAII HDDs and eSATAII devices without NCQ and Hot Plug functions

STEP 1: Set up BIOS.

- A. Enter BIOS SETUP UTILITY → Advanced screen → IDE Configuration.
- B. Set the “SATA Operation Mode” option to [non-RAID].

STEP 2: Install Windows® Vista™ OS on your system.

2.18 Untied Overclocking Technology

This motherboard supports Untied Overclocking Technology, which means during overclocking, FSB enjoys better margin due to fixed PCI / PCIE buses. Before you enable Untied Overclocking function, please enter “Overclock Mode” option of BIOS setup to set the selection from [Auto] to [Manual]. Then set the “PCIE Frequency (MHz)” option from [100MHz] to [101MHz], [102MHz] or [104MHz]. Therefore, CPU FSB is untied during overclocking, but PCI / PCIE buses are in the fixed mode so that FSB can operate under a more stable overclocking environment.

3. BIOS SETUP UTILITY

3.1 Introduction

This section explains how to use the BIOS SETUP UTILITY to configure your system. The Flash Memory on the motherboard stores the BIOS SETUP UTILITY. You may run the BIOS SETUP UTILITY when you start up the computer. Please press <F2> during the Power-On-Self-Test (POST) to enter the BIOS SETUP UTILITY, otherwise, POST will continue with its test routines.

If you wish to enter the BIOS SETUP UTILITY after POST, restart the system by pressing <Ctl> + <Alt> + <Delete>, or by pressing the reset button on the system chassis. You may also restart by turning the system off and then back on.



Because the BIOS software is constantly being updated, the following BIOS setup screens and descriptions are for reference purpose only, and they may not exactly match what you see on your screen.

3.1.1 BIOS Menu Bar

The top of the screen has a menu bar with the following selections:

- Main** To set up the system time/date information
- Advanced** To set up the advanced BIOS features
- H/W Monitor** To display current hardware status
- Boot** To set up the default system device to locate and load the Operating System
- Security** To set up the security features
- Exit** To exit the current screen or the BIOS SETUP UTILITY

Use <←> key or <→> key to choose among the selections on the menu bar, and then press <Enter> to get into the sub screen.

3.1.2 Navigation Keys

Please check the following table for the function description of each navigation key.

Navigation Key(s)	Function Description
← / →	Moves cursor left or right to select Screens
↑ / ↓	Moves cursor up or down to select items
+ / -	To change option for the selected items
<Enter>	To bring up the selected screen
<F1>	To display the General Help Screen
<F9>	To load optimal default values for all the settings
<F10>	To save changes and exit the BIOS SETUP UTILITY
<ESC>	To jump to the Exit Screen or exit the current screen

3.2 Main Screen

When you enter the BIOS SETUP UTILITY, the Main screen will appear and display the system overview.

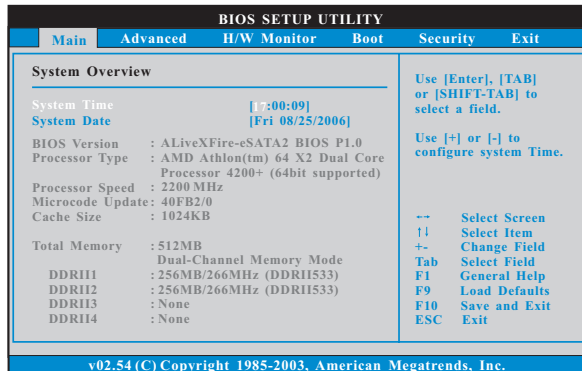

System Time [Hour:Minute:Second]

Use this item to specify the system time.

System Date [Day Month/Date/Year]

Use this item to specify the system date.

3.3 Advanced Screen

In this section, you may set the configurations for the following items: CPU Configuration, Chipset Configuration, ACPI Configuration, IDE Configuration, PCIPnP Configuration, Floppy Configuration, SuperIO Configuration, and USB Configuration.

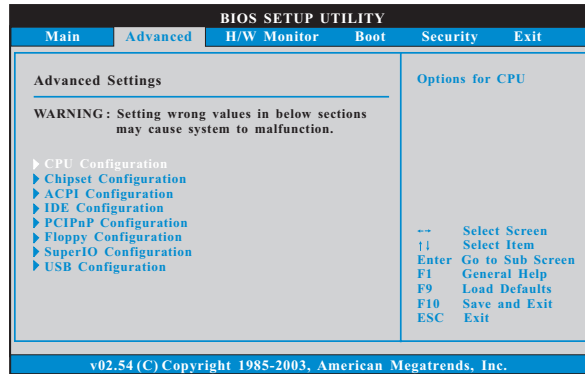

Setting wrong values in this section may cause the system to malfunction.

3.3.1 CPU Configuration

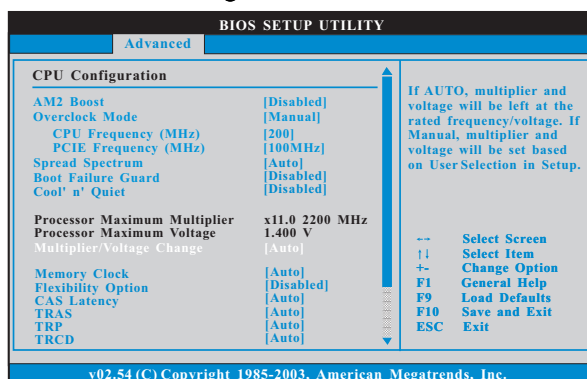

AM2 Boost

If you set this option to [Enabled], you will enable ASRock AM2 Boost function, which will improve the memory performance. The default value is [Disabled]. Please refer to caution 6 on page 8 for details.

Overclock Mode

Use this to select Overclock Mode. The default value is [Auto]. Configuration options: [Manual] and [Auto].

CPU Frequency (MHz)

Use this option to adjust CPU frequency. The default value is [200].

PCIE Frequency (MHz)

Use this option to adjust PCIE frequency. The default value is [100MHz].

Spread Spectrum

This feature will be set to [Auto] as default.

Boot Failure Guard

Enable or disable the feature of Boot Failure Guard.

Cool 'n' Quiet

Use this item to enable or disable AMD's Cool 'n' Quiet™ technology.

Dual Core Support

This item will show if you use Dual Core CPU. Configuration options: [Enabled], [Disabled]. The default value is [Enabled].

Processor Maximum Multiplier

It will display Processor Maximum Multiplier for reference.

Processor Maximum Voltage

It will display Processor Maximum Voltage for reference.

Multiplier/Voltage Change

This item is set to [Auto] by default. If it is set to [Manual], you may adjust the value of Processor Multiplier and Processor Voltage. However, it is recommended to keep the default value for system stability.

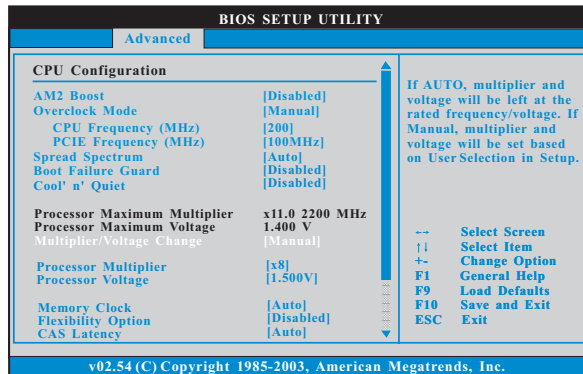

Processor Multiplier

This item will show when "Multiplier/Voltage Change" is set to [Manual]; otherwise, it will be hidden. You may set the value from [x8] up to [x25] but no higher than the value of "Processor Maximum Multiplier". For example, if the value of "Processor Maximum Multiplier" is [x11], the actual value of multiplier will be [x11] even if you set this item to a value higher than [x11]. However, for system stability, it is not recommended to adjust the value of this item.

Processor Voltage

This item will show when "Multiplier/Voltage Change" is set to [Manual]; otherwise, it will be hidden. You may set the value from [1.550V] down to [0.800V]. However, for safety and system stability, it is not recommended to adjust the value of this item.

Memory Clock

This item can be set by the code using [Auto]. You can set one of the standard values as listed: [200 MHz (DDRII 400)], [266 MHz (DDRII 533)], [333 MHz (DDRII 667)], and [400MHz (DDRII 800)].

Flexibility Option

The default value of this option is [Disabled]. It will allow better tolerance for memory compatibility when it is set to [Enabled].

CAS Latency

Use this item to adjust the means of memory accessing. Configuration options: [Auto], [3T], [4T], [5T], and [6T]. The default value is [Auto].

TRAS

Use this to adjust TRAS values. Configuration options: [Auto], [5CLK], [6CLK], [7CLK], [8CLK], [9CLK], [10CLK], [11CLK], [12CLK], [13CLK], [14CLK], [15CLK], [16CLK], [17CLK], and [18CLK]. The default value is [Auto].

TRP

Use this to adjust TRP values. Configuration options: [Auto], [3CLK], [4CLK], [5CLK], and [6CLK]. The default value is [Auto].

TRCD

Use this to adjust TRCD values. Configuration options: [Auto], [3CLK], [4CLK], [5CLK], and [6CLK]. The default value is [Auto].

TRRD

Use this to adjust TRRD values. Configuration options: [Auto], [2T], [3T], [4T], and [5T]. The default value is [Auto].

TRC

Use this to adjust TRC values. Configuration options: [11T] to [26T]. The default value is [Auto].

MA Timing

Use this to adjust values for MA timing. Configuration options: [Auto], [2T], [1T]. The default value is [Auto].

Bank Interleaving

Interleaving allows memory accesses to be spread out over banks on the same node, or across nodes, decreasing access contention.

3.3.2 Chipset Configuration

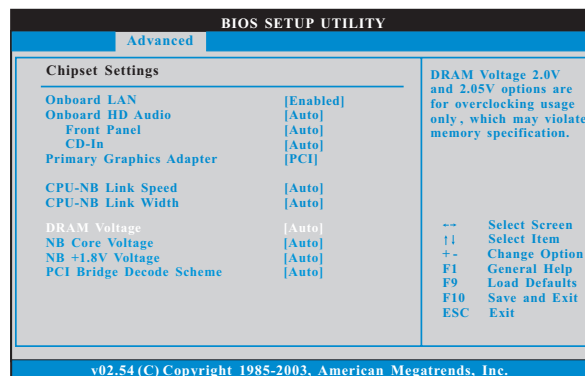

OnBoard LAN

This allows you to enable or disable the onboard LAN feature.

OnBoard HD Audio

Select [Auto], [Enabled] or [Disabled] for the onboard HD Audio feature. If you select [Auto], the onboard HD Audio will be disabled when PCI Sound Card is plugged.

Front Panel

Select [Auto], [Enabled] or [Disabled] for the onboard HD Audio Front Panel.

CD In

Select [Auto], [Enabled] or [Disabled] for the onboard HD Audio CD In.

Primary Graphics Adapter

This item will switch the PCI Bus scanning order while searching for video card. It allows you to select the type of Primary VGA in case of multiple video controllers. The default value of this feature is [PCI]. Configuration options: [PCI] and [PCIE].

CPU - NB Link Speed

This feature allows you selecting CPU to NB link frequency. Configuration options: [Auto], [200 MHz], [400 MHz], [600 MHz], [800 MHz], and [1000 MHz].

CPU - NB Link Width

This feature allows you selecting CPU to NB link width. Configuration options: [Auto], [8 bit], and [16 bit].

DRAM Voltage

Use this to select DRAM voltage. Configuration options: [Auto], [1.85V], [1.9V], [1.95V], [2.0V], and [2.05V]. The default value is [Auto]. DRAM Voltage 2.0V and 2.05V options are for overclocking usage only, which may violate memory specification.

NB Core Voltage

Use this to select NB core voltage. Configuration options: [Auto], [Ultra High], [High], [Normal], and [Low]. The default value is [Auto].

NB +1.8V Voltage

Use this to select NB +1.8V voltage. Configuration options: [Auto], [High], and [Low]. The default value is [Auto].

PCI Bridge Decode Scheme

Use this to select PCI bridge decode scheme. Configuration options: [Auto], [Positive], and [Subtractive].

3.3.3 ACPI Configuration

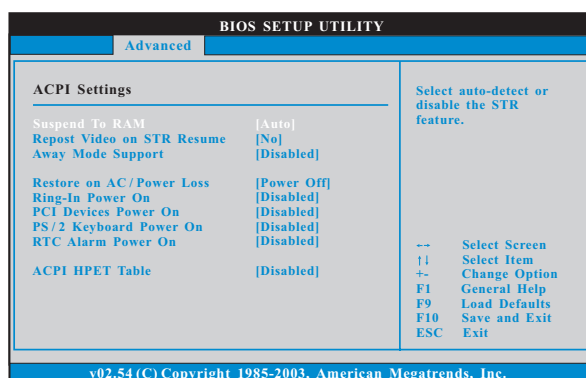

Suspend to RAM

Use this item to select whether to auto-detect or disable the Suspend-to-RAM feature. Select [Auto] will enable this feature if the OS supports it. If you set this item to [Disabled], the function “Repost Video on STR Resume” will be hidden.

Repost Video on STR Resume

This feature allows you to repost video on STR resume. (STR refers to suspend to RAM.)

Away Mode Support

Use this item to enable or disable Away Mode support under Windows® XP Media Center OS. The default value is [Disabled].

Restore on AC/Power Loss

This allows you to set the power state after an unexpected AC/power loss. If [Power Off] is selected, the AC/power remains off when the power recovers. If [Power On] is selected, the AC/power resumes and the system starts to boot up when the power recovers.

Ring-In Power On

Use this item to enable or disable Ring-In signals to turn on the system from the power-soft-off mode.

PCI Devices Power On

Use this item to enable or disable PCI devices to turn on the system from the power-soft-off mode.

PS/2 Keyboard Power On

Use this item to enable or disable PS/2 keyboard to turn on the system from the power-soft-off mode.

RTC Alarm Power On

Use this item to enable or disable RTC (Real Time Clock) to power on the system.

ACPI HPET Table

Use this item to enable or disable ACPI HPET Table. The default value is [Disabled]. Please set this option to [Enabled] if you plan to use this motherboard to submit Windows® Vista™ certification.

3.3.4 IDE Configuration

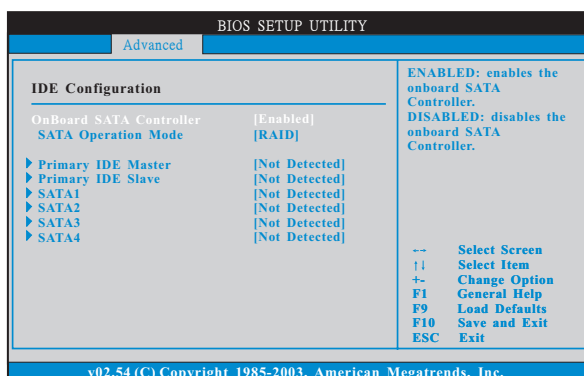

OnBoard SATA Controller

Use this item to enable or disable the "OnBoard SATA Controller" feature.

SATA Operation Mode

Use this item to adjust SATA Operation Mode. The default value of this option is [RAID]. If you want to operate RAID function on SATA / SATAII HDDs, please select [RAID]. Configuration options: [AHCI], [non-RAID], and [RAID].

IDE Device Configuration

You may set the IDE configuration for the device that you specify. We will use the "Primary IDE Master" as the example in the following instruction, which can be applied to the configurations of "Primary IDE Slave" as well.

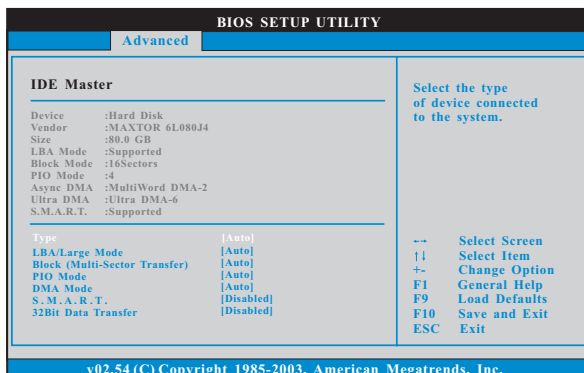

TYPE

Use this item to configure the type of the IDE device that you specify.
Configuration options: [Not Installed], [Auto], [CD/DVD], and [ARMD].

[Not Installed]: Select [Not Installed] to disable the use of IDE device.

[Auto]: Select [Auto] to automatically detect the hard disk drive.



After selecting the hard disk information into BIOS, use a disk utility, such as FDISK, to partition and format the new IDE hard disk drives. This is necessary so that you can write or read data from the hard disk. Make sure to set the partition of the Primary IDE hard disk drives to active.

[CD/DVD]: This is used for IDE CD/DVD drives.

[ARMD]: This is used for IDE ARMD (ATAPI Removable Media Device), such as MO.

LBA/Large Mode

Use this item to select the LBA/Large mode for a hard disk > 512 MB under DOS and Windows; for Netware and UNIX user, select [Disabled] to disable the LBA/Large mode.

Block (Multi-Sector Transfer)

The default value of this item is [Auto]. If this feature is enabled, it will enhance hard disk performance by reading or writing more data during each transfer.

PIO Mode

Use this item to set the PIO mode to enhance hard disk performance by optimizing the hard disk timing.

DMA Mode

DMA capability allows the improved transfer-speed and data-integrity for compatible IDE devices.

S.M.A.R.T.

Use this item to enable or disable the S.M.A.R.T. (Self-Monitoring, Analysis, and Reporting Technology) feature. Configuration options: [Disabled], [Auto], [Enabled].

32Bit Data Transfer

Use this item to enable 32-bit access to maximize the IDE hard disk data transfer rate.

3.3.5 PCIPnP Configuration

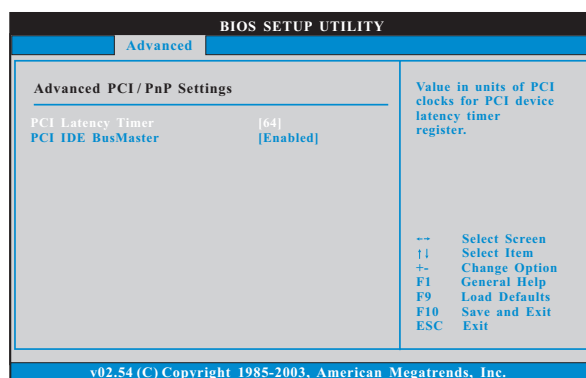

Setting wrong values in this section may cause the system to malfunction.

PCI Latency Timer

The default value is 32. It is recommended to keep the default value unless the installed PCI expansion cards' specifications require other settings.

PCI IDE BusMaster

Use this item to enable or disable the PCI IDE BusMaster feature.

3.3.6 Floppy Configuration

In this section, you may configure the type of your floppy drive.

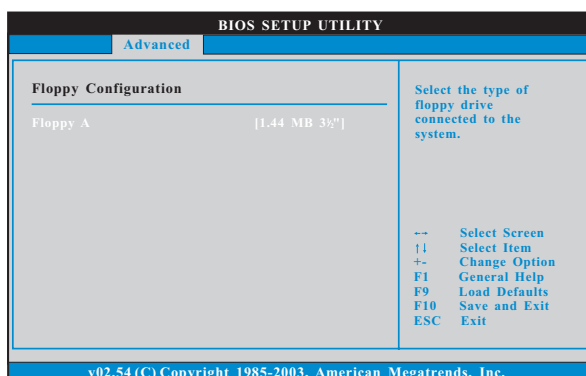

3.3.7 Super IO Configuration

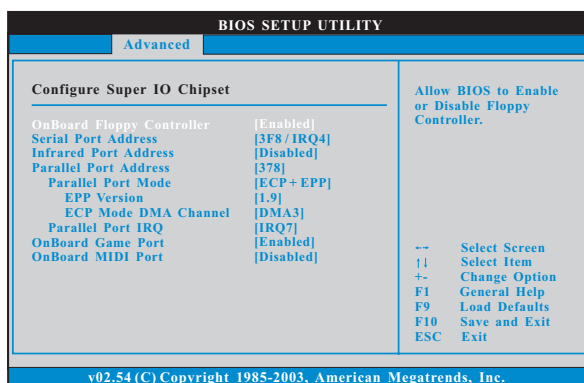

OnBoard Floppy Controller

Use this item to enable or disable floppy drive controller.

Serial Port Address

Use this item to set the address for the onboard serial port or disable it.

Configuration options: [Disabled], [3F8 / IRQ4], [2F8 / IRQ3], [3E8 / IRQ4], [2E8 / IRQ3].

Infrared Port Address

Use this item to set the address for the onboard infrared port or disable it.

Configuration options: [Disabled], [2F8 / IRQ3], and [2E8 / IRQ3].

Parallel Port Address

Use this item to set the address for the onboard parallel port or disable it.

Configuration options: [Disabled], [378], and [278].

Parallel Port Mode

Use this item to set the operation mode of the parallel port. The default value is [ECP+EPP]. If this option is set to [ECP+EPP], it will show the EPP version in the following item, "EPP Version". Configuration options: [Normal], [Bi-Directional], and [ECP+EPP].

EPP Version

Use this item to set the EPP version. Configuration options: [1.9] and [1.7].

ECP Mode DMA Channel

Use this item to set the ECP mode DMA channel. Configuration options: [DMA0], [DMA1], and [DMA3].

Parallel Port IRQ

Use this item to set the IRQ for the parallel port. Configuration options: [IRQ5] and [IRQ7].

OnBoard Game Port

Use this item to enable the Game Port or disable it.

OnBoard MIDI Port

Use this item to select the address for the MIDI Port or disable it. Configuration options: [Disabled], [300], and [330].

3.3.8 USB Configuration

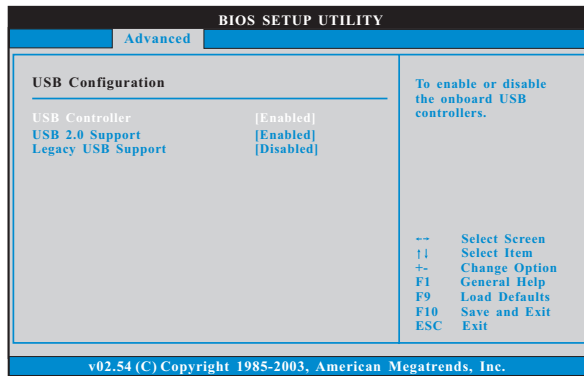

USB Controller

Use this item to enable or disable the use of USB controller.

USB 2.0 Support

Use this item to enable or disable the USB 2.0 support.

Legacy USB Support

Use this item to enable or disable the support to emulate the I/O devices of legacy OS (DOS) such as mouse, keyboard, USB flash... etc. Or you may select [Auto] so that the system will start to auto-detect; if there is no USB device connected, "Auto" option will disable the legacy USB support.

3.4 Hardware Health Event Monitoring Screen

In this section, it allows you to monitor the status of the hardware on your system, including the parameters of the CPU temperature, motherboard temperature, CPU fan speed, chassis fan speed, and the critical voltage.

BIOS SETUP UTILITY					
Main	Advanced	H/W Monitor	Boot	Security	Exit
Hardware Health Event Monitoring			You are allowed to enable this function only when you install 4-pin CPU fan.		
CPU Ambient Temperature	:	42°C / 107°F			
CPU Internal Temperature	:	52°C / 125°F			
M/B Temperature	:	31°C / 87°F			
CPU Fan Speed	:	2833 RPM			
Chassis Fan Speed	:	N/A			
Vcore	:	1.532 V	-->	Select Screen	
+ 3.30V	:	3.129 V	↑↓	Select Item	
+ 5.00V	:	4.877 V	F1	General Help	
+ 12.00V	:	11.741 V	F9	Load Defaults	
CPU Quiet Fan	:	[Disabled]	F10	Save and Exit	
			ESC	Exit	

v02.54 (C) Copyright 1985-2003, American Megatrends, Inc.

CPU Ambient Temperature

This item shows the temperature sensed by thermistor near CPU.

CPU Internal Temperature

This item shows the temperature sensed by dual current source CPU.

CPU Quiet Fan

This item allows you to identify the temperature of CPU fan. Configuration options: [Disabled] and [Enabled]. The default value is [Disabled]. You are allowed to enable this function only when you install 4-pin CPU fan.

3.5 Boot Screen

In this section, it will display the available devices on your system for you to configure the boot settings and the boot priority.

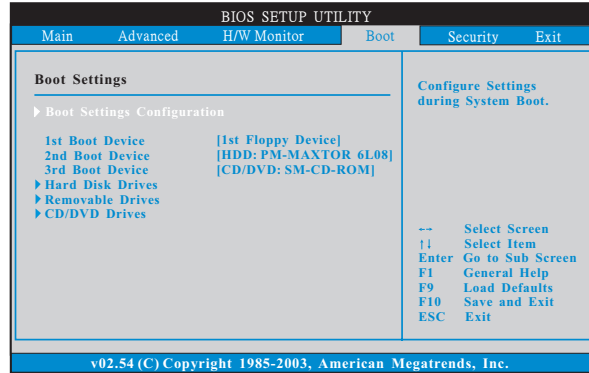

3.5.1 Boot Settings Configuration

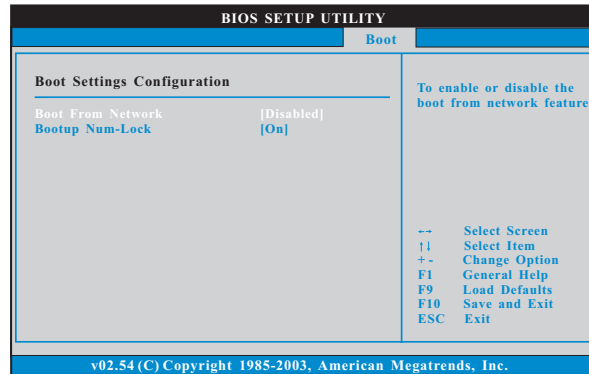

Boot From Network

Use this item to enable or disable the Boot From Network feature.

Boot Up Num-Lock

If this item is set to [On], it will automatically activate the Numeric Lock function after boot-up.

3.6 Security Screen

In this section, you may set or change the supervisor/user password for the system. For the user password, you may also clear it.

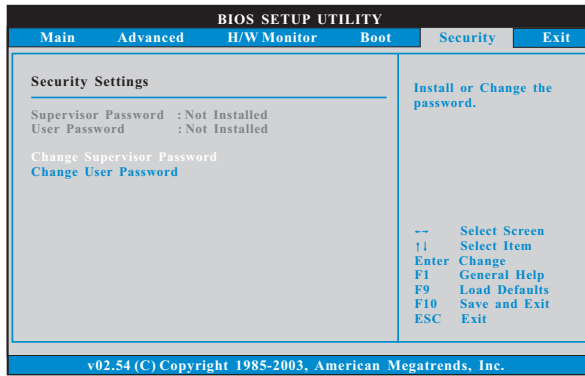

3.7 Exit Screen

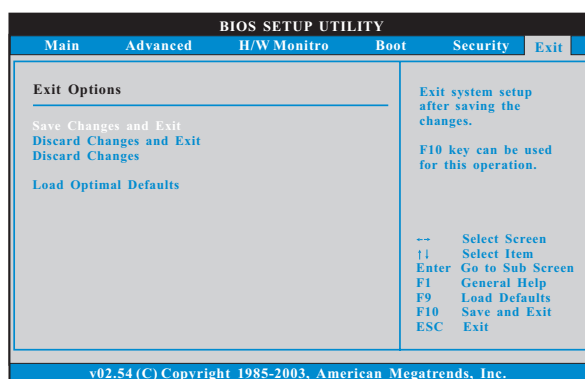

Save Changes and Exit

When you select this option, it will pop-out the following message, “Save configuration changes and exit setup?” Select [OK] to save the changes and exit the BIOS SETUP UTILITY.

Discard Changes and Exit

When you select this option, it will pop-out the following message, “Discard changes and exit setup?” Select [OK] to exit the BIOS SETUP UTILITY without saving any changes.

Discard Changes

When you select this option, it will pop-out the following message, “Discard changes?” Select [OK] to discard all changes.

Load Optimal Defaults

When you select this option, it will pop-out the following message, “Load optimal defaults?” Select [OK] to load the default values for all the setup configurations.

4. Software Support

4.1 Install Operating System

This motherboard supports various Microsoft® Windows® operating systems: 2000 / XP / XP Media Center / XP 64-bit / Vista™. Because motherboard settings and hardware options vary, use the setup procedures in this chapter for general reference only. Refer to your OS documentation for more information.

4.2 Support CD Information

The Support CD that came with the motherboard contains necessary drivers and useful utilities that enhance the motherboard features.

4.2.1 Running The Support CD

To begin using the support CD, insert the CD into your CD-ROM drive. The CD automatically displays the Main Menu if "AUTORUN" is enabled in your computer. If the Main Menu did not appear automatically, locate and double click on the file "ASSETUP.EXE" from the BIN folder in the Support CD to display the menus.

4.2.2 Drivers Menu

The Drivers Menu shows the available devices drivers including ASRock Express GbL PCI Express LAN card driver if the system detects the installed devices. Please install the necessary drivers to activate the devices.

4.2.3 Utilities Menu

The Utilities Menu shows the applications software that the motherboard supports. Click on a specific item then follow the installation wizard to install it.

4.2.4 Contact Information

If you need to contact ASRock or want to know more about ASRock, welcome to visit ASRock's website at <http://www.asrock.com>; or you may contact your dealer for further information.

APPENDIX:

AMD's Cool 'n' Quiet™ Technology

For power-saving sake, it is strongly recommended to enable AMD's Cool 'n' Quiet™ technology under Windows® system. When using this feature, please make sure to install "AMD Processor Driver" from the "Support CD" first.

If you are using Windows® 2000/XP operating system, please follow the instruction below to enable AMD's Cool 'n' Quiet™ technology:

1. From the Windows® 2000/XP operating system, click the Start button. Select Settings, then Control Panel.
2. Switch to Classic View. (for Windows® XP only)
3. Double-click the Display icon in the Control Panel then select the Screen Saver tab.
4. Click the "Power..." button. The following dialog box appears.
5. From the Power schemes combo list box, select **Minimal Power Management**.
6. Click OK to implement settings.