





AK77-333F AK77-333FN Online Manual





DOC. NO.: AK77333FN-OL-E0211A



What's in this manual

AK77-333F / AK77-333FN	1
<i>What's in this manual</i>	2
<i>You Must Notice</i>	9
<i>Before You Start</i>	10
<i>Overview</i>	11
<i>Feature Highlight</i>	12
<i>Quick Installation Procedure</i>	16
<i>Motherboard Map</i>	17
<i>Block Diagram</i>	18
Hardware Installation	19
<i>About "Manufacturer Upgrade Optional" and "User Upgrade Optional"</i>	20
<i>JP14 Clear CMOS Data</i>	21
<i>CPU Installation</i>	22
 <i>AOpen Overheat Protection (O.H.P.) Technology</i>	24
<i>JP28 KB/Mouse Wake-up Enable/Disable Jumper</i>	25
<i>CPU Jumper-less Design</i>	26
<i>CPU and Housing Fan Connector (with H/W Monitoring)</i>	31
<i>JP20 K7 Host Clock Selection</i>	32

	DIMM Sockets	33
	Front Panel Connector	35
	ATX Power Connector	36
	AC Power Auto Recovery	36
	STBY LED	37
	IDE and Floppy Connector	38
	S/PDIF (Sony/Philips Digital Interface) Connector	40
	Super 5.1 Channel Audio Effect	41
	IrDA Connector	42
	WOM (Zero Voltage Wake on Modem) Connector	43
	WOL (Wake on LAN)	46
	AGP (Accelerated Graphic Port) 4X Expansion Slot	48
	AGP Protection Technology and AGP LED	49
	CNR (Communication and Network Riser) Expansion Slot	50
	PC99 Color Coded Back Panel	51
	Support Six USB 2.0 Port	52
	Support 10/100 Mbps LAN onboard (AK77-333FN only)	53
	Chassis Intrusion Sensor	54
	CD Audio Connector	55

AUX-IN Connector	56
Front Audio Connector	57
Battery-less and Long Life Design	58
CPU Over-current Protection	59
 AConfig Utility.....	60
Resetable Fuse	62
2200 μ F Low ESR Capacitor.....	63
Layout (Frequency Isolation Wall).....	65
 Enlarged Aluminum Heatsink	66
Open JukeBox Player.....	67
 Vivid BIOS technology.....	71
Driver and Utility	72
Auto-run Menu from Bonus CD Disc	73
Installing Windows 95	74
Installing Windows 98	75
Installing Windows® 98 SE, Windows® ME & Windows® 2000/XP.....	76
Installing VIA 4 in 1 Driver.....	77
Installing Onboard Sound Driver	78
 The noise is gone!! --- SilentTek	79

Installing USB2.0 Driver 82

Installing LAN Driver (AK77-333FN only) 83

PHOENIX-AWARD BIOS 87

How To Use Phoenix Award™ BIOS Setup Program 88

How To Enter BIOS Setup 90



BIOS Upgrade under Windows environment 91

Overclocking 93

VGA Card & Hard Disk 94

Glossary 95

AC97 95

ACPI (Advanced Configuration & Power Interface) 95

AGP (Accelerated Graphic Port) 95

AMR (Audio/Modem Riser) 96

AOpen Bonus Pack CD 96

APM (Advanced Power Management) 96

ATA (AT Attachment) 96

ATA/66 96

ATA/100 97

ATA/133 97

<i>BIOS (Basic Input/Output System)</i>	97
<i>Bus Master IDE (DMA mode)</i>	97
<i>CNR (Communication and Networking Riser)</i>	98
<i>CODEC (Coding and Decoding)</i>	98
<i>DDR (Double Data Rate) SDRAM</i>	98
<i>DIMM (Dual In Line Memory Module)</i>	98
<i>DMA (Direct Memory Access)</i>	99
<i>ECC (Error Checking and Correction)</i>	99
<i>EDO (Extended Data Output) Memory</i>	99
<i>EEPROM (Electronic Erasable Programmable ROM)</i>	99
<i>EPROM (Erasable Programmable ROM)</i>	99
<i>EV6 Bus</i>	100
<i>FCC DoC (Declaration of Conformity)</i>	100
<i>FC-PGA (Flip Chip-Pin Grid Array)</i>	100
<i>Flash ROM</i>	100
<i>FSB (Front Side Bus) Clock</i>	101
<i>I²C Bus</i>	101
<i>IEEE 1394</i>	101
<i>Parity Bit</i>	102

<i>PBSRAM (Pipelined Burst SRAM)</i>	102
<i>PC-100 DIMM</i>	102
<i>PC-133 DIMM</i>	102
<i>PC-1600 / PC-2100/ PC-2700 / PC-3200 DDR DRAM</i>	103
<i>PCI (Peripheral Component Interface) Bus</i>	103
<i>PDF Format</i>	103
<i>PnP (Plug and Play)</i>	103
<i>POST (Power-On Self Test)</i>	104
<i>RDRAM (Rambus DRAM)</i>	104
<i>RIMM (Rambus Inline Memory Module)</i>	104
<i>SDRAM (Synchronous DRAM)</i>	104
<i>Shadow E²PROM</i>	105
<i>SIMM (Single In Line Memory Module)</i>	105
<i>SMBus (System Management Bus)</i>	105
<i>SPD (Serial Presence Detect)</i>	105
<i>Ultra DMA</i>	106
<i>USB (Universal Serial Bus)</i>	106
<i>VCM (Virtual Channel Memory)</i>	107
<i>ZIP file</i>	107

Troubleshooting..... 108

Technical Support 112

Product Registration 115

How to Contact Us 116

You Must Notice



Adobe, the Adobe logo, and Acrobat are trademarks of Adobe Systems Incorporated.

AMD, the AMD logo, Athlon and Duron are trademarks of Advanced Micro Devices, Inc.

Intel, the Intel logo, Intel Celeron, Pentium II, Pentium III, Pentium 4 are trademarks of Intel Corporation.

Microsoft, Windows, and Windows logo are either registered trademarks or trademarks of Microsoft Corporation in the United States and/or other countries.

All product and brand names used on this manual are used for identification purposes only and may be the registered trademarks of their respective owners.

All of the specifications and information contained in this manual are subject to change without notice. AOpen reserves the right to revise this publication and to make reasonable changes. AOpen assumes no responsibility for any errors or inaccuracies that may appear in this manual, including the products and software described in it.

This documentation is protected by copyright law. All rights are reserved.

No part of this document may be used or reproduced in any form or by any means, or stored in a database or retrieval system without prior written permission from AOpen Corporation.

Copyright© 1996-2002, AOpen Inc. All Rights Reserved.

Before You Start



This Online Manual will introduce how this product is installed to the user. All useful information will be described in later chapters. Please keep this manual carefully for future upgrades or system configuration changes. This Online Manual is saved in [PDF format](#), we recommend using Adobe Acrobat Reader 4.0 for online viewing, it is included in [Bonus CD disc](#) or you can get free download from [Adobe web site](#).

Although this Online Manual is optimized for screen viewing, it is still capable for hardcopy printing, you can print it by A4 paper size and set 2 pages per A4 sheet on your printer. To do so, choose **File > Page Setup** and follow the instruction of your printer driver.

Thanks for the helping in saving our earth.

Overview

Thanks for choosing AOpen AK77-333F / AK77-333FN. The AK77-333F / AK77-333FN is AMD® Socket 462 motherboard (M/B) based on the ATX form factor featuring the [VIA Apollo KT333 chipset](#). As high performance chipset built in the M/B, the AK77-333F / AK77-333FN AMD® Socket 462 series Athlon™ & Duron™ and AthlonXP™ processor (with CPU Overheat Protection circuit to Athlon™XP CPU only) and 200/266/333MHz [EV6](#) system bus. In the AGP performance, it has one AGP slot and supports AGP /4X mode and pipelined spilt-transaction long burst transfer up to 1056MB/sec. With high bandwidth 200/266/333MB/s 8-bit V-Link Host Controller, [DDR333\(PC2700\)](#) and [DDR266\(PC2100\)DDR SDRAM](#) can be applied to the AK77-333F / AK77-333FN and the maximum memory size can be up to 3GB. The on-board IDE controller supports [Ultra DMA 66/100/133](#) mode and the transfer rate up to 133MB/s. Further flexibility can be achieved by taking advantage of the [Communication and Network Riser \(CNR\)](#) card option that allows audio and modem configuration on a single baseboard design. More than that, on the strength of RealTek RTL8100BL controller on board, which is an highly-integrated Platform LAN Connect device, it provides 10/100M bps Ethernet for office and home use (AK77-333FN only). Besides, the AK77-333F / AK77-333FN has an [AC97 CODEC Realtek ALC650](#) chipset onboard for providing high performance and magic surround stereo sound to let people enjoy working with it. More than that, this motherboard supports [USB 2.0](#) function with a fancy speed of up to 480Mbps. Now, let's enjoy all features from AOpen AK77-333F / AK77-333FN.

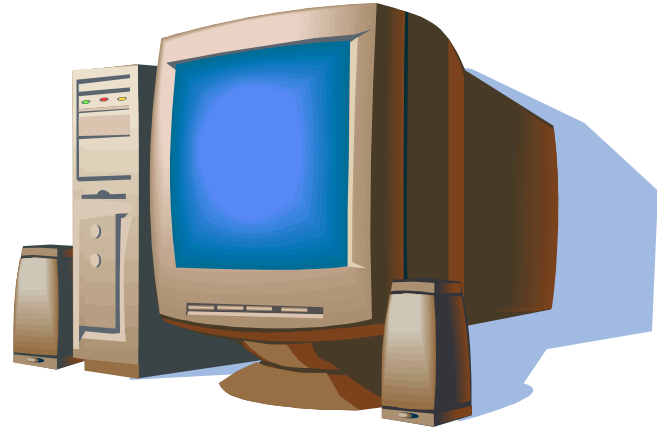

Feature Highlight

CPU

Supports AMD® Socket 462 series CPU with 200/266/333 MHz [EV6 Bus](#) designed for Socket 462 technology.

Athlon: 600MHz~1.4GHz

Duron: 600MHz~1.3GHz

AthlonXP: 1500+(1.33GHz)~2800+(2.25GHz)

Chipset

The VIA Apollo KT333 consists of the KT333 V-Link [DDR](#) Host system controller and the VT8235 highly integrated V-Link Client PCI/LPC controller. The Host system controller provides superior performance between the CPU, SDRAM, AGP bus, and V-Link interface with pipelined, burst, and concurrent operation. The VT8235 V-Link Client controller is a highly integrated PCI/LPC controller. Its internal bus structure is based on 66MHz PCI bus that provides 4x bandwidth compare to previous generation PCI/ISA bridge chips. The VT8235 integrated Client V-Link controller with 200/266MB/s bandwidth between Host/Client V-Link interface, providing a V-Link-PCI and V-Link-LPC controller.

Ultra DMA 66/100/133 Bus Master IDE

Comes with an on-board PCI Bus Master IDE controller with two connectors that supports four IDE devices in two channels, supports [Ultra DMA](#) 66/100/133, PIO Modes 3 and 4 and Bus Master IDE DMA Mode 4, and supports Enhanced IDE devices.

Expansion Slots

Including six 32-bit/33MHz PCI, one CNR and one AGP 4X slots. The [PCI](#) local bus throughput can be up to 132MB/s. The [Communication & Networking Riser \(CNR\)](#) slot provided from AK77-333F / AK77-333FN can support CNR interface for a Modem/Audio card. The [Accelerated Graphics Port \(AGP\)](#) specification provides a new level of video display sophistication and speed. The AGP video cards support data transfer rate up to 1056MB/s. As AK77-333F / AK77-333FN includes one AGP expansion slot for a bus mastering AGP graphic card, For AD and SBA signaling, AK77-333F / AK77-333FN can support 133MHz 2X/4X mode. Of six PCI slots provided, all of them support master PCI slots for arbitration and decoding functions.

Memory

With VIA Apollo KT333 chipset, the AK77-333F / AK77-333FN can support [Double-Data-Rate \(DDR\) RAM](#). The DDR RAM interface allows zero wait state bursting between the RAM and the data buffers at 333/266/200 MHz. The six banks of DDR RAM can be composed of an arbitrary mixture of 64, 128, 256, 512MB x N DDR RAM and maximum up to 3GB. The AK77-333F / AK77-333FN allows DDR RAM to run at either synchronous or pseudo-synchronous mode with the host CPU bus frequency (333/266/200MHz).

LAN Port (AK77-333FN only)

On the strength of RealTek RTL8100BL controller on board, which is an highly-integrated Platform LAN Connect device, it provides 10/100 Mbps Ethernet for office and home use.

On-board AC97 Sound

AK77-333F / AK77-333FN uses the [AC97](#) CODEC RealTek ALC650 chip, which supports high quality of 5.1 Channel audio effects. This on-board audio includes a complete audio recording and playback system.



Six USB 2.0 Connectors

Provides three ports, six [USB](#) connectors for USB interface devices, such as mouse, keyboard, modem, scanner, etc. Please be noted that USB 2.0, with fancy speed up to 480Mbps, is 40 times faster than the traditional ones. Except for the speed increase, USB 2.0 supports old USB 1.0/1.1 software and peripherals, offering impressive and even better compatibility to customers.

1MHz Stepping Frequency Adjustment

Provides “1MHz Stepping Frequency Adjustment” function in the BIOS. This magic function allows you to adjust CPU [FSB](#) frequency from 100~191 by 1MHz stepping, and lets your system get maximum performance.

Watch Dog Timer

Includes AOpen “Watch Dog Timer” function that can auto-reset system in 4.8 seconds when you fail to system overclocking.

Power Management/Plug and Play

The AK77-333F / AK77-333FN supports the power management function that confirms to the power-saving standards of the U.S. Environmental Protection Agency (EPA) Energy Star program. It also offers [Plug-and-Play](#), which helps saving users from configuration problems, thus making the system much more user-friendly.

Hardware Monitoring Management

Supports CPU or system fans status, temperature and voltage monitoring and alert, through the on-board hardware monitor module and [AOpen Hardware Monitoring Utility](#).

Enhanced ACPI

Fully implement the [ACPI](#) standard for Windows® 95/98/ME/NT/2000/XP series compatibility, and supports Soft-Off, STR (Suspend to RAM, S3), STD (Suspend to Disk, S4), WOM (Wake On Modem), WOL (Wake On LAN) features.

Super Multi-I/O

The AK77-333F / AK77-333FN provides two high-speed UART compatible serial ports and one parallel port with EPP and ECP capabilities. UART2 can also be directed from COM2 to the Infrared Module for the wireless connections.

Quick Installation Procedure

This page gives you a quick procedure on how to install your system. Follow each step accordingly.

1. [Installing CPU and Fan](#)
2. [Installing System Memory \(DIMM\)](#)
3. [Connecting Front Panel Cable](#)
4. [Connecting IDE and Floppy Cable](#)
5. [Connecting ATX Power Cable](#)
6. [Connecting Back Panel Cable](#)
7. [Power-on and Load BIOS Setup Default](#)
8. [Setting CPU Frequency](#)
9. Reboot
10. [Installing Driver and Utility](#)

Motherboard Map

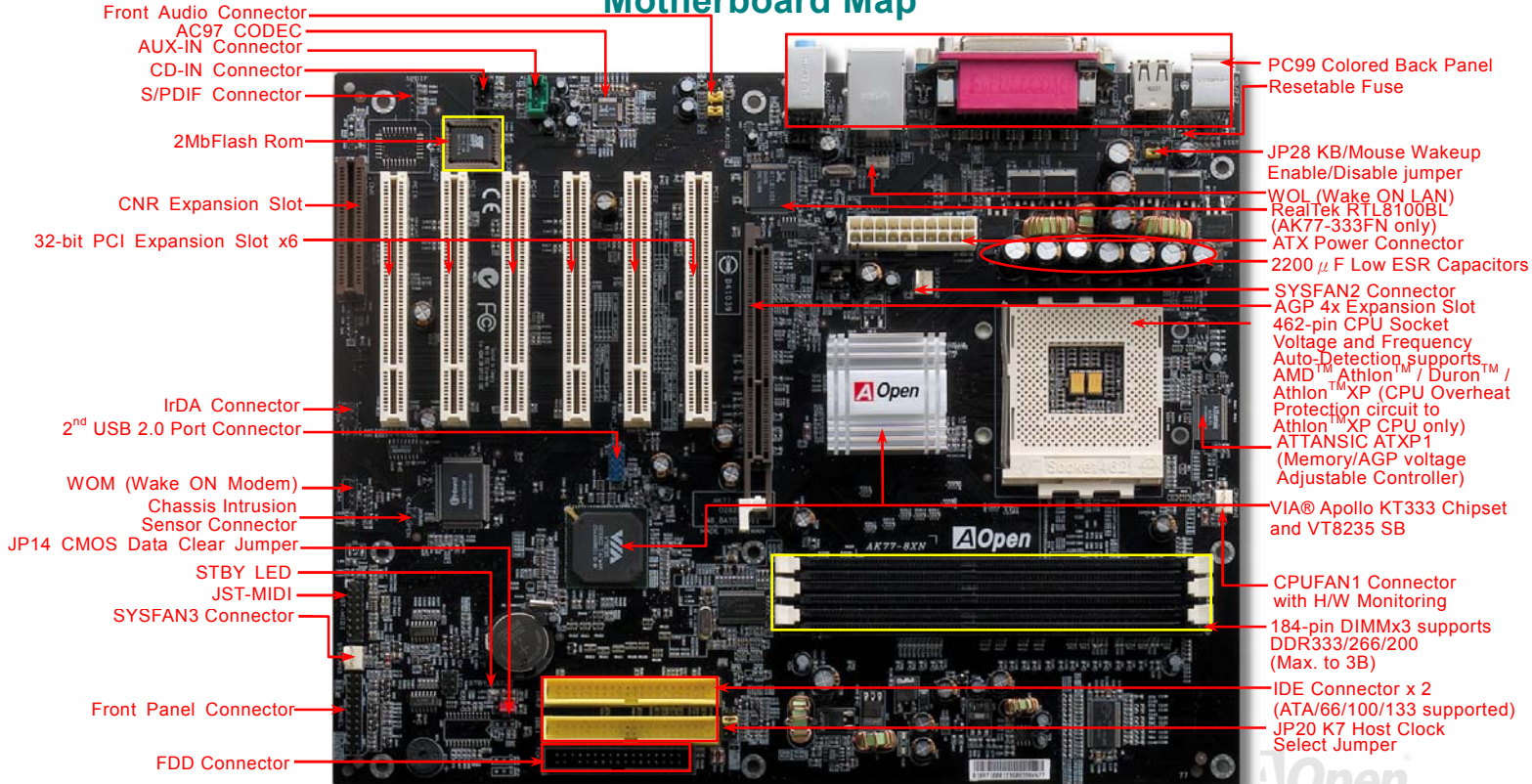

Block Diagram

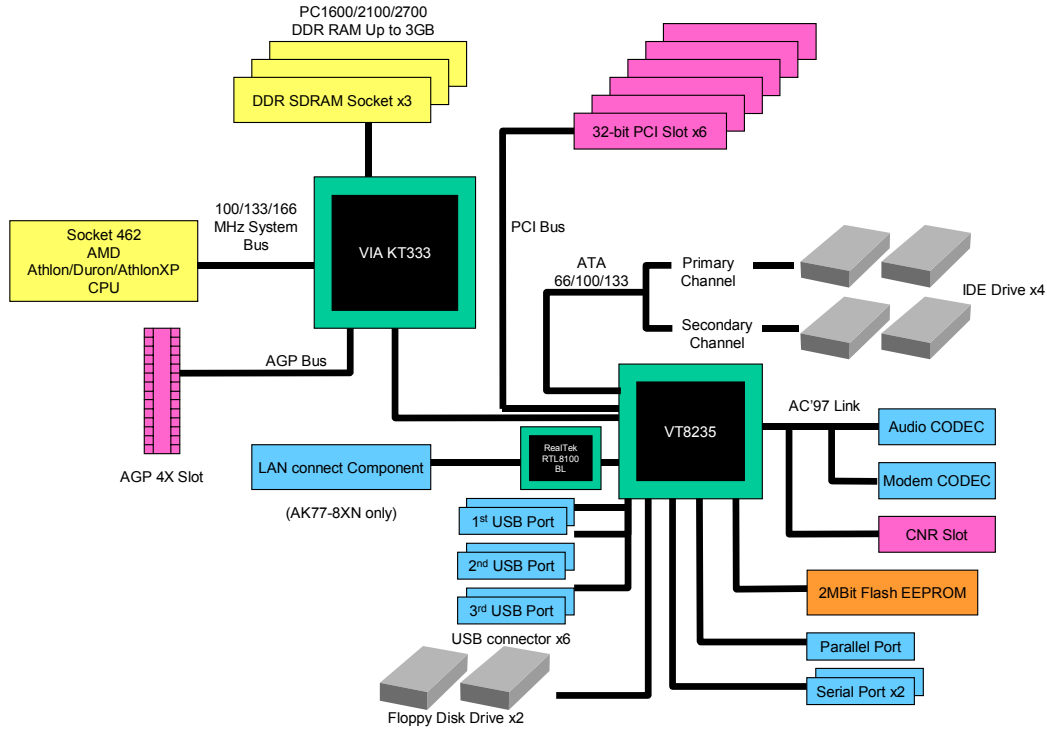

Hardware Installation

This chapter describes jumpers, connectors and hardware devices of this motherboard.



Note: *Electrostatic discharge (ESD) can damage your processor, disk drives, expansion boards, and other components. Always observe the following precautions before you install a system component.*

1. *Do not remove a component from its protective packaging until you are ready to install it.*
2. *Wear a wrist ground strap and attach it to a metal part of the system unit before handling a component. If a wrist strap is not available, maintain contact with the system unit throughout any procedures requiring ESD protection.*

About “Manufacturer Upgrade Optional” and “User Upgrade Optional”...

When you read this online manual and start to assemble your computer system, you may find some of functions are called “Manufacturer Upgrade Optional”, and some are called “User Upgrade Optional”. Though all AOpen motherboards include many amazing and powerful features, in some situations, these powerful features are not used to every user. Hence, we changed some key features as “Manufacturer Upgrade Optional” for you to choose. Some optional functions that can be upgraded by users, we call them “User Upgrade Optional”. As for those optional functions that can't be upgraded by ourselves, we call them “Manufacturer Upgrade Optional”. If needed, you can contact our local distributors or resellers for purchasing “User Upgrade Optional” components, and again you can visit AOpen official web site: <http://english.aopen.com.tw/> for more detail information.



JP14 Clear CMOS Data

You can clear CMOS to restore system default setting. To clear the CMOS, follow the procedures below.

1. Turn off the system and unplug the AC power.
2. Remove ATX power cable from connector PWR2.
3. Locate JP14 and short pins 2-3 for a few seconds.
4. Return JP14 to its normal setting by shorting pin 1 & pin 2.
5. Connect ATX power cable back to connector PWR2.

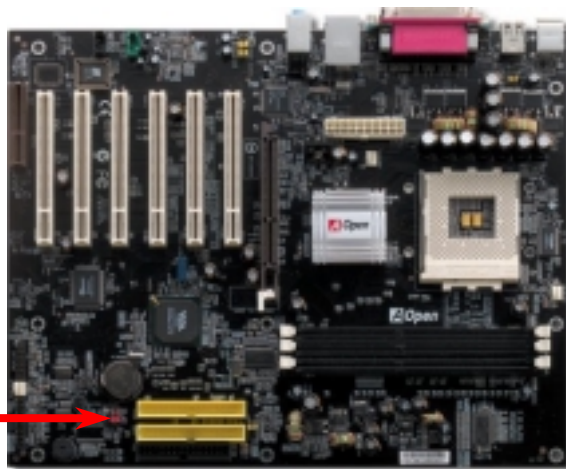
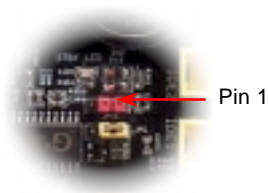

Tip: When should I Clear CMOS?

1. Boot fail because of overclocking...
2. Forget password...
3. Troubleshooting...

CPU Installation

This motherboard supports AMD® Athlon and Duron Socket 462 series CPU. Be careful of CPU orientation when you plug it into CPU socket (with **CPU Overheat Protection** function implemented, the system will be automatically power off when the temperature of CPU reached 97 degree, but only works on AthlonXP CPU only).

1. Pull up the CPU socket lever and up to 90-degree angle.

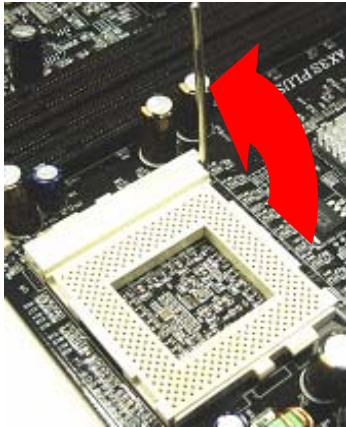

2. Locate Pin 1 in the socket and look for a black dot or cut edge on the CPU upper interface. Match Pin 1 and cut edge, then insert the CPU into the socket.

CPU socket
Lever

CPU pin 1
and cut edge

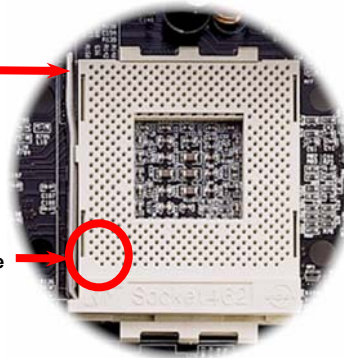

Black dot and
cut edge

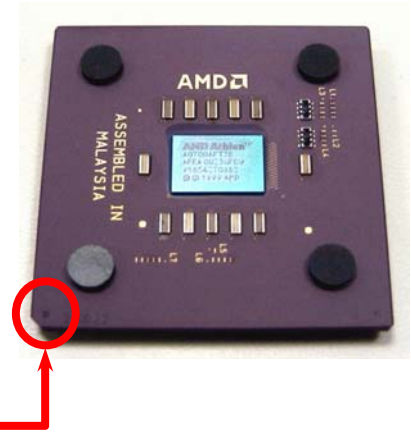

Note: This picture is for example only, it may not exactly be the same motherboard.

3. Press down the CPU socket lever and finish CPU installation.

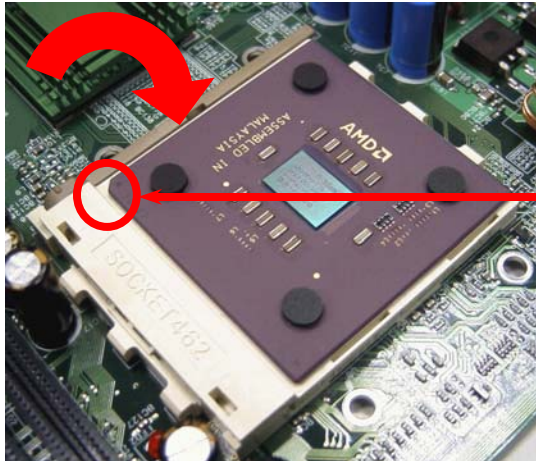

CPU cut edge

Note: If you do not match the CPU socket Pin 1 and CPU cut edge well, it may damage the CPU.

Note: This picture is for example only, it may not exactly be the same motherboard.

AOpen Overheat Protection (O.H.P.) Technology

With AMD platform substantially keeps increasing the speed of its CPU, it inevitably led to the annoying problem of high CPU operation temperature at the same time. In order to prevent accidental failure of CPU fan, which could cause the burning down of the AthlonXP CPU, we, AOpen, have meticulously developed a new technology, named, O.H.P. (Overheat Protection) Technology to protect them. Thanks to the intelligent monitoring design of AOpen O.H.P. technology, user can now finally set their mind at ease even when fan failed to work without fearing the possible damage of CPU.

Under the circumstances that CPU fan is running properly, AthlonXP temperature should be way below the highest temperature

limit of 97°C. However, if CPU fan accidentally becomes malfunction or improperly installed, the CPU temperature would rocket abruptly, and you may find your system hang up or crying over the smoking CPU if you haven't installed AOpen O.H.P. previously. With AOpen O.H.P. technology applied, the specific thermal detection pins on AthlonXP CPU would sense voltage difference when processor is overheated with fan failed, and the overheat protection system would immediately send out a signal to abort your system by cutting CPU electricity before any damage is done. Unlike other manufacturers who use BIOS or software to control the power supply of CPU, AOpen O.H.P. Technology is purely hardware-controlled the minute after system boot-up, and occupies no system resource. We are pleasant to phase in this practical function on all AOpen AMD series motherboards to protect customer's valuable hardware and personal data.

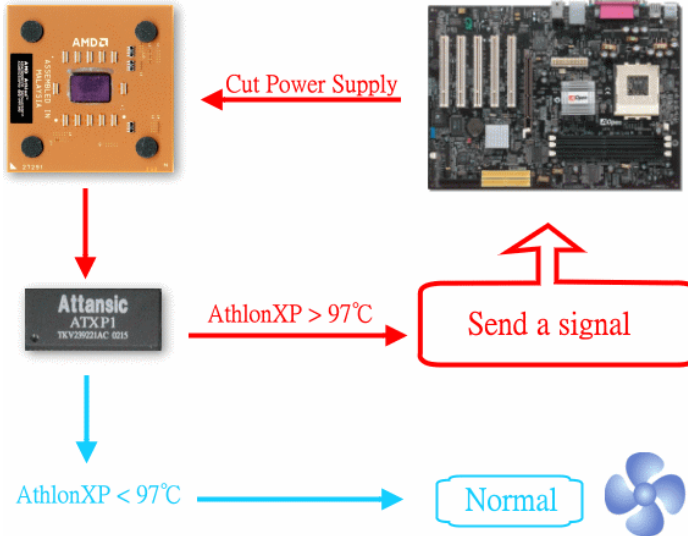

JP28 KB/Mouse Wake-up Enable/Disable Jumper

This motherboard provides keyboard / mouse wake-up function. You can use JP28 to enable or disable this function, which could resume your system from suspend mode with keyboard or mouse installed. The factory default setting is set to "Disable"(1-2), and you may enable this function by setting the jumper to 2-3.



JP28 KB/Mouse
Wake-up Jumper



Disable
(Default)



Enable

CPU Jumper-less Design

CPU VID signal and [SMBus](#) clock generator provide CPU voltage auto-detection and allows the user to set the CPU frequency through the [BIOS setup](#), therefore no jumpers or switches are used. The disadvantages of the Pentium based jumper-less designs are eliminated. There will be no worry of wrong CPU voltage detection.

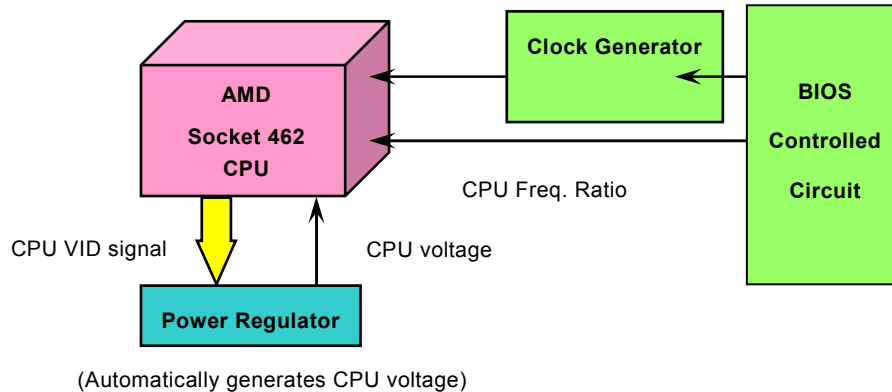

Full-range Adjustable CPU Core Voltage

This function is dedicated to overclockers. The CPU core voltage of this motherboard is adjustable 1.1V to 1.85V by 0.05V stepping. But this motherboard can also automatically detect CPU VID signal and generates proper CPU core voltage.

BIOS Setup > Frequency/Voltage Control > CPU Voltage Setting

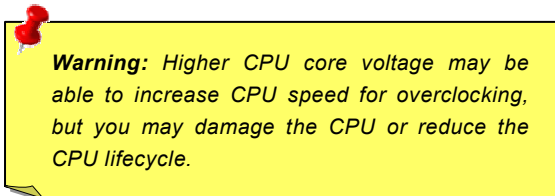

Setting CPU Frequency

This motherboard is CPU jumper-less design, you can set CPU frequency through the BIOS setup, and no jumpers or switches are needed.

BIOS Setup > Frequency/Voltage Control > CPU Speed Setting

CPU Ratio	From 5.5x to 16.5x step 0.5x; 17x to 18x step 1x
CPU FSB (By manual Adjustment)	FSB=100, 100~129 by 1MHz stepping adjustment technology FSB=133, 130~160 by 1MHz stepping adjustment technology FSB=166, 161~191 by 1MHz stepping adjustment technology

Warning: VIA® Apollo KT333 chipset supports 166MHz FSB (with performance reaches maximum 266MHz EV6 system bus) and 66MHz AGP clock, higher clock setting may cause serious system damage.

Warning: Supposed you have had adjusted CPU ratio on your current CPU, and you plan to replace a new CPU. Please use <Home> key or Clear CMOS to restore the default setting when changing a new CPU, because the system will still implement the previous CPU setting on the new one.



Tip: If your system hangs or fails to boot because of overclocking, simply use <Home> key to restore the default setting or you can wait the AOpen "Watch Dog Timer" reset the system after five seconds and system will auto-detect hardware again.

Supported CPU Frequency

Core Frequency = CPU Bus Clock * CPU Ratio
AGP Clock = PCI Clock x 2

PCI Clock = CPU Bus Clock / Clock Ratio
EV6 Bus Speed = CPU external bus clock x 2

CPU	CPU Core Frequency	EV6 Bus Clock	Ratio
Athlon 1G	1GHz	200MHz	10.0x
Athlon 1.1G	1.1GHz	200MHz	11.0x
Athlon 1.2G	1.2GHz	200MHz	12.0x
Athlon 1.3G	1.3GHz	200MHz	13.0x
Athlon 1G	1GHz	266MHz	7.5x
Athlon 1.13G	1.13GHz	266MHz	8.5x
Athlon 1.2G	1.2GHz	266MHz	9.0x
Athlon 1.33G	1.33GHz	266MHz	10.0x
Athlon 1.4G	1.4GHz	266MHz	10.5x
AthlonXP 1500+	1.3GHz	266MHz	10.0x
AthlonXP 1600+	1.4GHz	266MHz	10.5x
AthlonXP 1700+	1.46GHz	266MHz	11.0x
AthlonXP 1800+	1.53GHz	266MHz	11.5x
AthlonXP 1900+	1.6GHz	266MHz	12.0x
AthlonXP 2000+	1.667GHz	266MHz	12.5x
AthlonXP 2100+	1.73GHz	266MHz	13x
AthlonXP 2200+	1.80GHz	266MHz	13.5x
AthlonXP 2400+	2.0GHz	266MHz	15x
AthlonXP 2600+	2.13GHz	266MHz	16x
AthlonXP 2700+	2.16GHz	333MHz	13x
AthlonXP 2800+	2.25GHz	333MHz	13.5x
Duron 800	800MHz	200MHz	8.0x
Duron 850	850MHz	200MHz	8.5x
Duron 900	900MHz	200MHz	9.0x
Duron 950	950MHz	200MHz	9.5x
Duron 1G	1GHz	200MHz	10.0x
Duron 1.1G	1.1GHz	200MHz	11.0x

Note: With CPU speed changing rapidly, there might be fastest CPU on the market by the time you received this installation guide. This table is kindly for your references only.

Note: This motherboard support CPU auto-detection function. Hence, you don't need to setup the CPU frequency manually.

Warning: To avoid possible CPU damage caused by overheating, CPU Overheat Protection circuit had been especially designed on this motherboard. System would be automatically power off when this motherboard detected a CPU temperature above 97 degree.

AOpen “Watch Dog Timer”



With this motherboard, AOpen provides a very special, useful feature for overclockers. When you power-on the system, the BIOS will check last system [POST](#) status. If POST succeeded, the BIOS will enable “Watch Dog Timer” function immediately, and set the CPU [FSB](#) frequency by user’s setting that stored in the BIOS. If system failed in BIOS POST, the “Watch Dog Timer” will reset the system to reboot in five seconds. Then, BIOS will detect the CPU’s default frequency and POST again. With this special feature, you can easily overclock your system to get higher system performance without removing the cover of system housing, and be able to set the jumper to clear CMOS data when your system hanged.

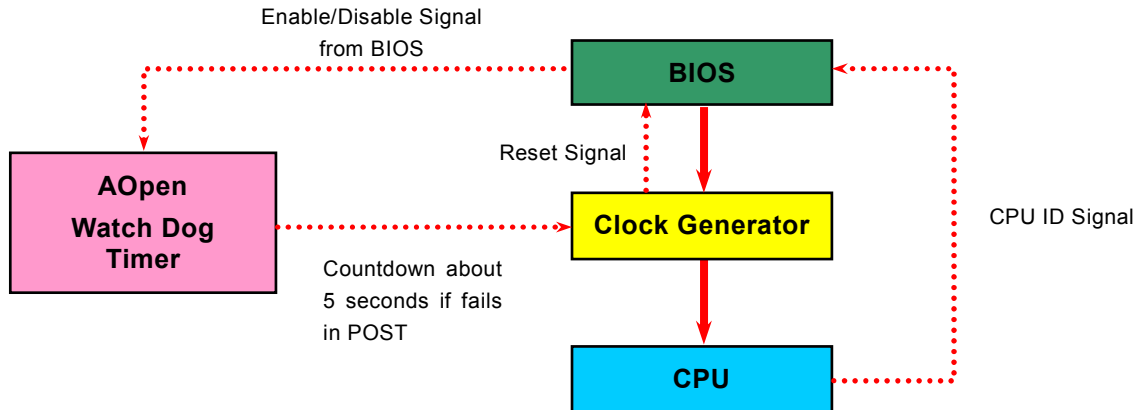

CPU and Housing Fan Connector (with H/W Monitoring)

Plug in the CPU fan cable to the 3-pin **CPUFAN1** connector. If you have chassis fan, you can also plug it on **SYSFAN2** (FAN2) or **SYSFAN3** (FAN3) connector.

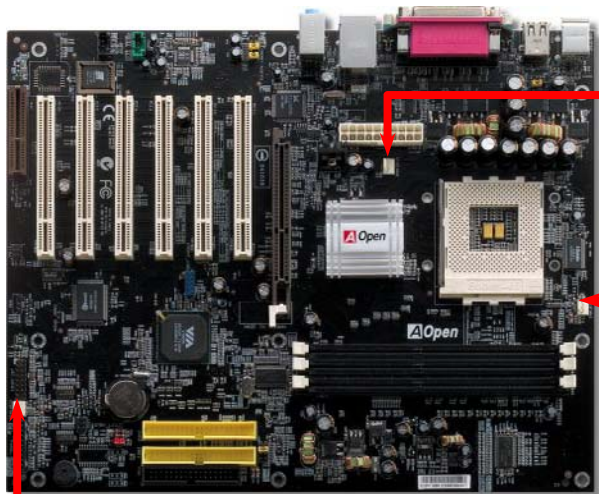

SYSFAN2 Connector

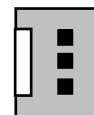

GND
+12V
SENSOR

CPUFAN1 Connector

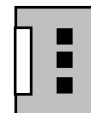

GND
+12V
SENSOR

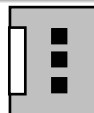

GND
+12V
SENSOR

SYSFAN3 Connector

Note: Some CPU fans do not have sensor pin, so that cannot support fan monitoring.

JP20 K7 Host Clock Selection



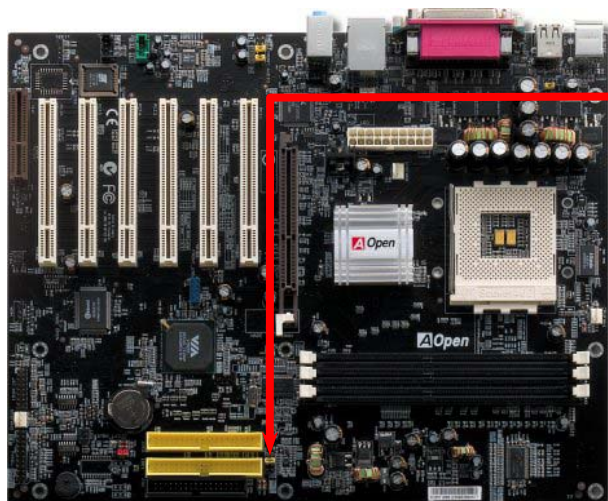



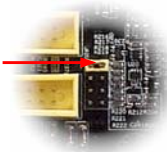

This jumper is used to specify the relationship of PCI and FSB clock. Generally speaking, if you are not overclockers, we recommend you to set it to the default setting. Additionally, this motherboard also provides “**1MHz Stepping Adjustment**” feature for overclockers to adjust CPU FSB frequency via BIOS setup program. Based on the CPU type, the adjustment range has three levels: 100~129, 130~160 and 161~191MHz for your choosing. If you fix the CPU FSB frequency by JP20, the “1MHz Stepping Adjustment” range will be changed and following the JP20 setting.



Pin 1



JP20 CPU Type
Select Jumper

1	2	
		FSB100
		FSB133
		FSB166
		FSB200

DIMM Sockets

This motherboard has three 184-pin DDR DIMM sockets that allow you to install [DDR200/266/333](#) memory up to 3 GB. Non-ECC DDR RAM is supported. Otherwise, it will cause serious damage on memory sockets or RAM module. Newly implemented function, the Voltage of memory on this motherboard is adjustable from 2.5V to 2.65V for over clocking purpose.

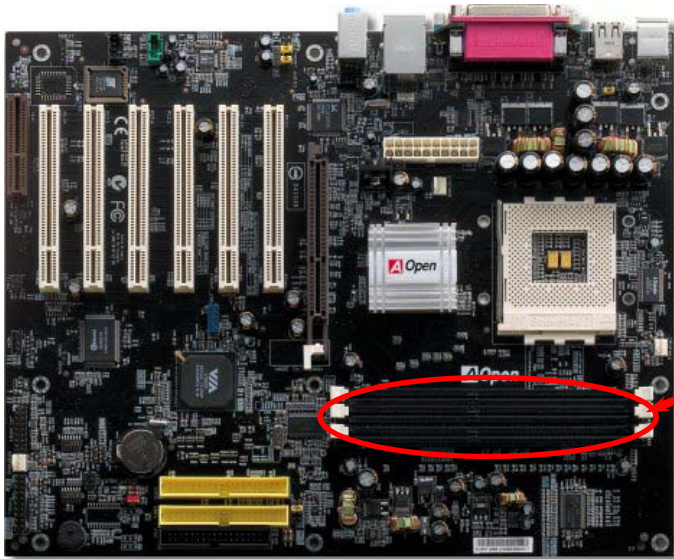

Warning: This motherboard supports DDR RAM, please do not install the SDRAM on the DDR RAM sockets. Otherwise, it will cause serious damage on memory sockets or RAM module.



How to Install Memory Modules

Please follow the procedure as shown below to finish memory installation.

1. Make sure the DIMM module's pin face down and match the socket's size as depicted below.



2. Insert the module straight down to the DIMM slot with both hands and press down firmly until the DIMM module is securely in place.

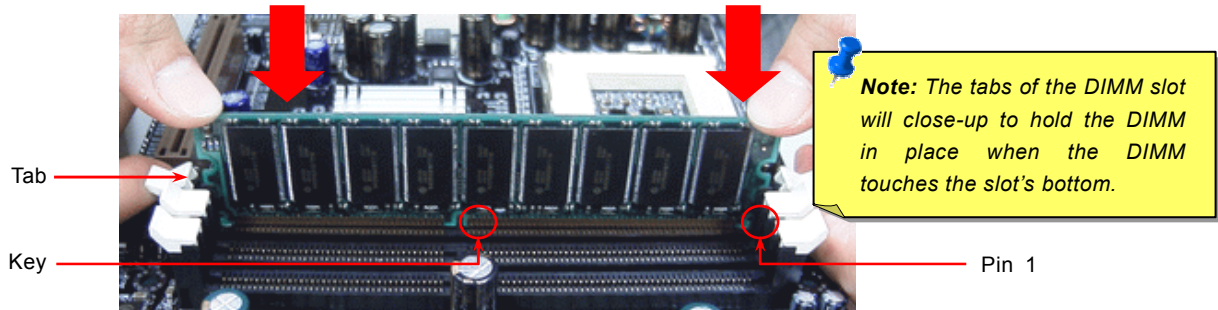

3. Repeat step 2 to finish additional DIMM modules installation.

Front Panel Connector



Attach the power LED, speaker, power and reset switch connectors to the corresponding pins. If you enable “Suspend Mode” item in BIOS Setup, the ACPI & Power LED will keep flashing while the system is in suspend mode.

Locate the power switch cable from your ATX housing. It is 2-pin female connector from the housing front panel. Plug this connector to the soft-power switch connector marked **SPWR**.

Suspend Type	ACPI LED
Power on Suspend (S1)	Blinking between green and red
Suspend to RAM (S3) or Suspend to Disk (S4)	Blinking between green and red

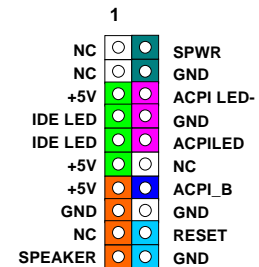
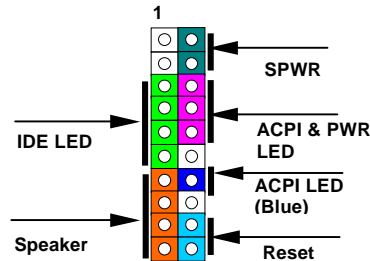

ATX Power Connector

The ATX power supply uses 20-pin connector shown below. Make sure you plug in the right direction.

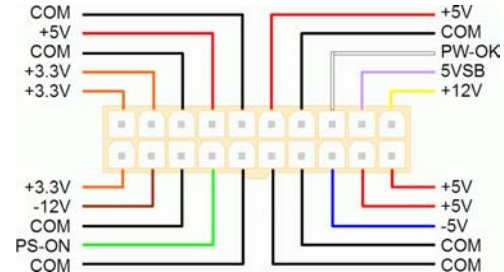
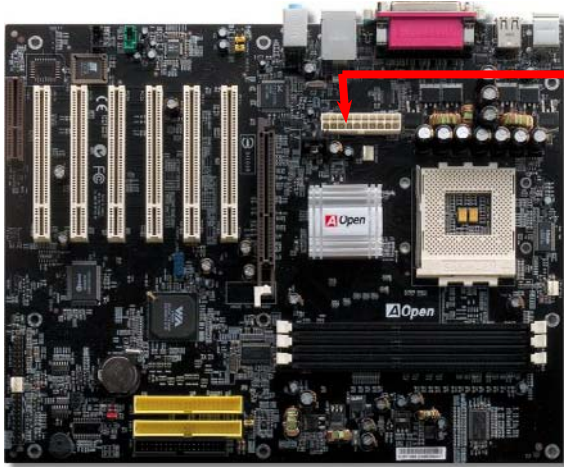

AC Power Auto Recovery

A traditional ATX system should remain at power off stage when AC power resumes from power failure. This design is inconvenient for a network server or workstation, without an UPS, that needs to keep power-on. This motherboard implements an AC Power Auto Recovery function to solve this problem.

STBY LED

Both STBY LED and BOOT LED are AOpen's considerate designs that we aim at providing you friendly system information. The STBY LED will light up when power is provided to the motherboard. This is a convenient indication for you to check the system power status in many circumstances such as power on/off, stand-by mode and RAM power status during Suspend to RAM mode.

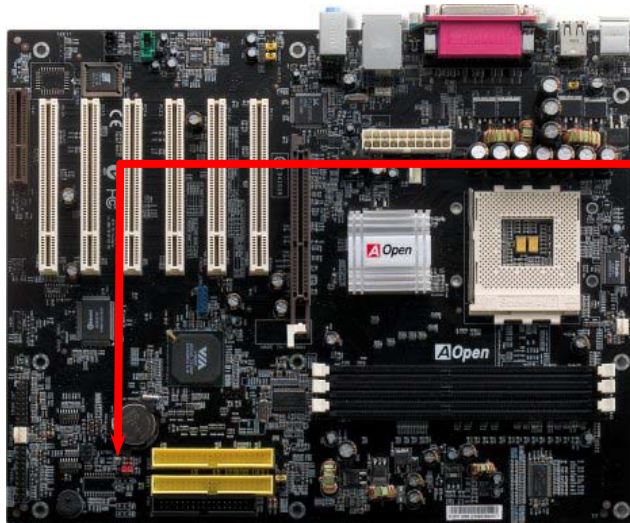

System
Power LED



Warning: Do not install or remove the DIMM module or others devices when the STBY LED lights on.

IDE and Floppy Connector

Connect 34-pin floppy cable and 40-pin IDE cable to floppy connector FDC connector. Be careful of the pin1 orientation. Wrong orientation may cause system damage.

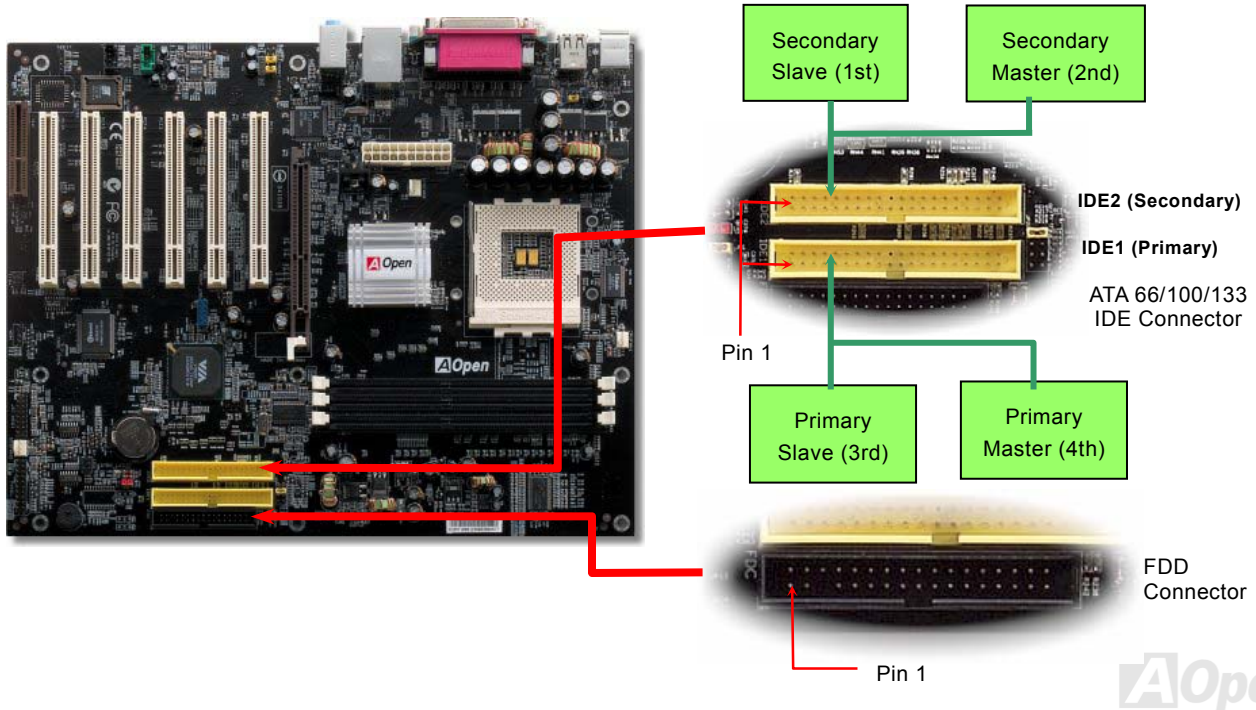

IDE1 is also known as the primary channel and IDE2 as the secondary channel. Each channel supports two IDE devices that make a total of four devices. In order to work together, the two devices on each channel must be set differently to **Master** and **Slave** mode. Either one can be the hard disk or the CDROM. The setting as master or slave mode depends on the jumper on your IDE device, so please refer to your hard disk and CDROM manual accordingly.

This motherboard supports [ATA66](#), [ATA100](#) or [ATA133](#) DE devices. Following table lists the transfer rate of IDE PIO and DMA modes. The IDE bus is 16-bit, which means every transfer is two bytes.

Mode	Clock Period	Clock Count	Cycle Time	Data Transfer Rate
PIO mode 0	30ns	20	600ns	$(1/600\text{ns}) \times 2\text{byte} = 3.3\text{MB/s}$
PIO mode 1	30ns	13	383ns	$(1/383\text{ns}) \times 2\text{byte} = 5.2\text{MB/s}$
PIO mode 2	30ns	8	240ns	$(1/240\text{ns}) \times 2\text{byte} = 8.3\text{MB/s}$
PIO mode 3	30ns	6	180ns	$(1/180\text{ns}) \times 2\text{byte} = 11.1\text{MB/s}$
PIO mode 4	30ns	4	120ns	$(1/120\text{ns}) \times 2\text{byte} = 16.6\text{MB/s}$
DMA mode 0	30ns	16	480ns	$(1/480\text{ns}) \times 2\text{byte} = 4.16\text{MB/s}$
DMA mode 1	30ns	5	150ns	$(1/150\text{ns}) \times 2\text{byte} = 13.3\text{MB/s}$
DMA mode 2	30ns	4	120ns	$(1/120\text{ns}) \times 2\text{byte} = 16.6\text{MB/s}$
ATA33	30ns	4	120ns	$(1/120\text{ns}) \times 2\text{byte} \times 2 = 33\text{MB/s}$
ATA66	30ns	2	60ns	$(1/60\text{ns}) \times 2\text{byte} \times 2 = 66\text{MB/s}$
ATA100	20ns	2	40ns	$(1/40\text{ns}) \times 2\text{byte} \times 2 = 100\text{MB/s}$
ATA133	15ns	2	30ns	$(1/30\text{ns}) \times 2\text{byte} \times 2 = 133\text{MB/s}$

Warning: The specification of the IDE cable is a maximum of 46cm (18 inches); make sure your cable does not exceed this length.

Tip:

- For better signal quality, it is recommended to set the far end side device to master mode and follow the suggested sequence to install your new device. Please refer to above diagram
- To achieve the best performance of Ultra DMA 66/100/133 hard disks, a special **80-wires IDE cable** for Ultra DMA 66/100/133 is required.

S/PDIF (Sony/Philips Digital Interface) Connector

S/PDIF (Sony/Philips Digital Interface) is a newest audio transfer format, which provides impressive quality through optical fiber and allows you to enjoy digital audio instead of analog audio. Normally there are two S/PDIF outputs as shown, one for RCA connector, the most common one used for consumer audio products, and the other for optical connector with better audio quality. Through a specific audio cable, you can connect the S/PDIF connector to other end of the S/PDIF audio module, which bears S/PDIF digital output. However, you must have a S/PDIF supported speaker/amplifier/decoder with S/PDIF digital input to connect to the S/PDIF digital output to make the most out of this function.

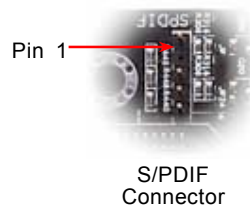
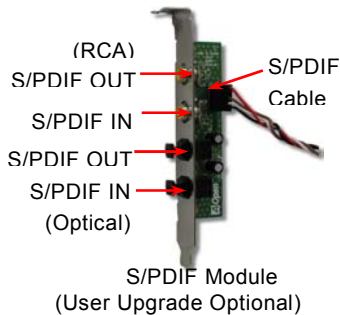

- | | | |
|---|---|-----------|
| 1 | ● | +5V |
| | ● | NC |
| | ● | S/PDIFOUT |
| | ● | GND |
| | ● | S/PDIFIN |





Super 5.1 Channel Audio Effect

This motherboard comes with an ALC650 CODEC, which supports high quality of 5.1 Channel audio effects, bringing you a brand new audio experience. On the strength of the innovative design of ALC650, you're able to use standard line-jacks for surround audio output without connecting any external module. To apply this function, you have to install the audio driver in the Bonus Pack CD as well as an audio application supporting 5.1 Channel. Picture bellow represents the standard location of all speakers in 5.1 Channel sound tracks. Please connect the plug of your front speakers to the green "Speaker out" port, rear speakers' plug to the blue "Line in" port and both of the center and subwoofer speakers to the red "MIC in" port.

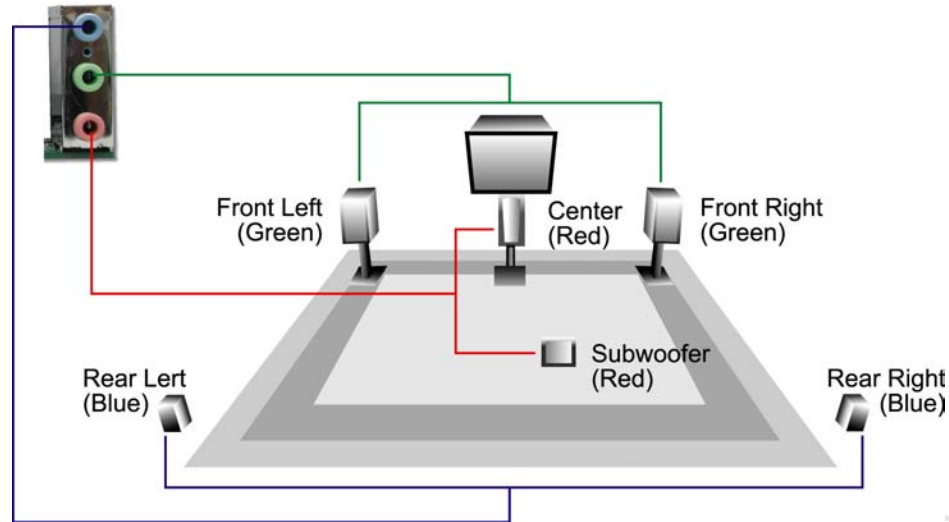

IrDA Connector

The IrDA connector can be configured to support wireless infrared module, with this module and application software such as Laplink or Windows 95 Direct Cable Connection, the user can transfer files to or from laptops, notebooks, PDA devices and printers. This connector supports HPSIR (115.2Kbps, 2 meters) and ASK-IR (56Kbps).

Install the infrared module onto the **IrDA** connector and enable the infrared function from BIOS Setup, UART2 Mode, make sure to have the correct orientation when you plug in the IrDA connector.

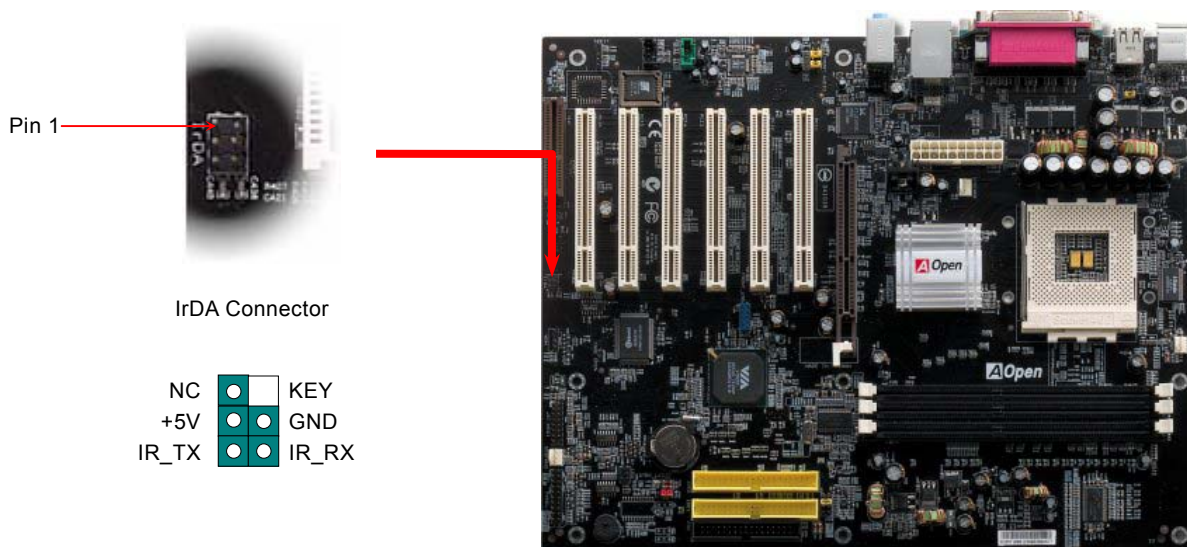

WOM (Zero Voltage Wake on Modem) Connector

This motherboard implements special circuit to support Wake On Modem, both Internal modem card and external box modem are supported. Since Internal modem card consumes no power when system power is off, it is recommended to use an internal modem. To use internal modem, connect 4-pin cable from **RING** connector of modem card to the **WOM** connector on the motherboard.

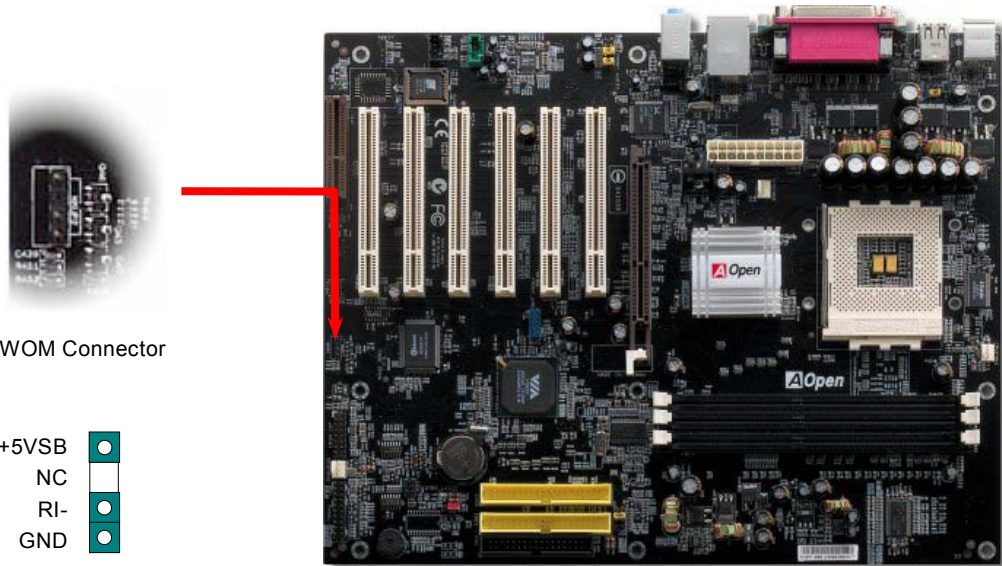

WOM by External BOX Modem

Traditional Green PC suspend mode does not really turn off the system power supply, it uses external box modem to trigger MB COM port and resume back to active.

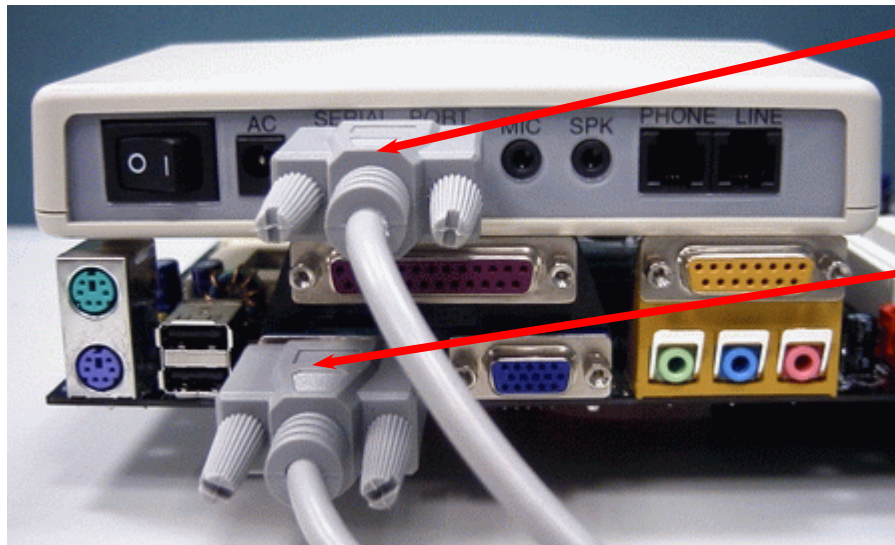

Serial Port
(Modem Side)

Serial Port
(Motherboard Side)

Note: This picture is for example only, it may not exactly be the same motherboard.

WOM by Internal Modem Card

With the help of the ATX soft power On/Off, it is possible to have a system totally power off, and wakeup to automatically answer a phone call as an answering machine or to send/receive a fax. You may identify whether or not your system is in true power off mode by checking to see if the fan of your power supply is off. Both an external box modem and an internal modem card can be used to support Modem Wake Up, but if you use an external modem, you have to leave your box modem on.

WOM Connector
(Motherboard Side)

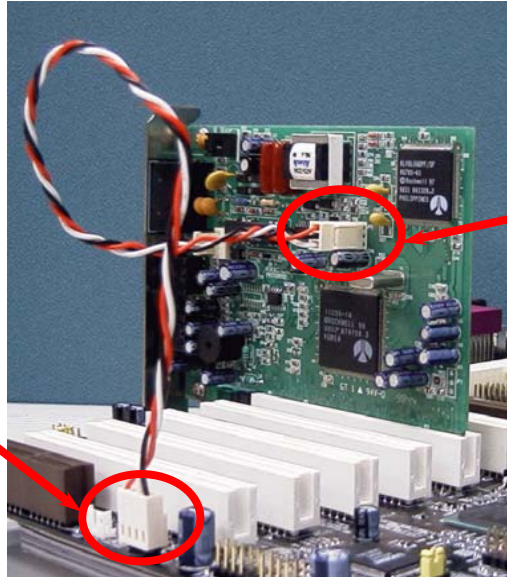

WOM Connector
(Modem Card Side)

Note: This picture is for example only, it may not exactly be the same motherboard.

WOL (Wake on LAN)

This feature is very similar as Wake On Modem, but it goes through local area network. To use Wake On LAN function, you must have a network card with chipset that supports this feature, and connect a cable from LAN card to motherboard WOL connector. The system identification information (probably IP address) is stored on network card and because there is a lot of traffic on the Ethernet, you need to install network management software, such as ADM, for the checking of how to wake up the system. Note that, at least 600mA ATX standby current is required to support the LAN card for this function.

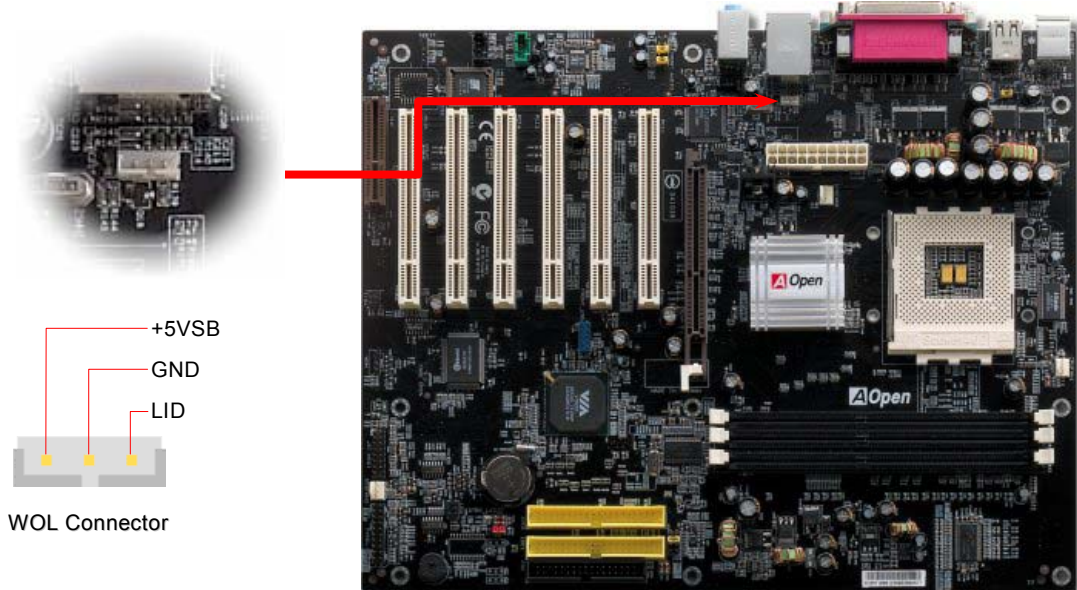

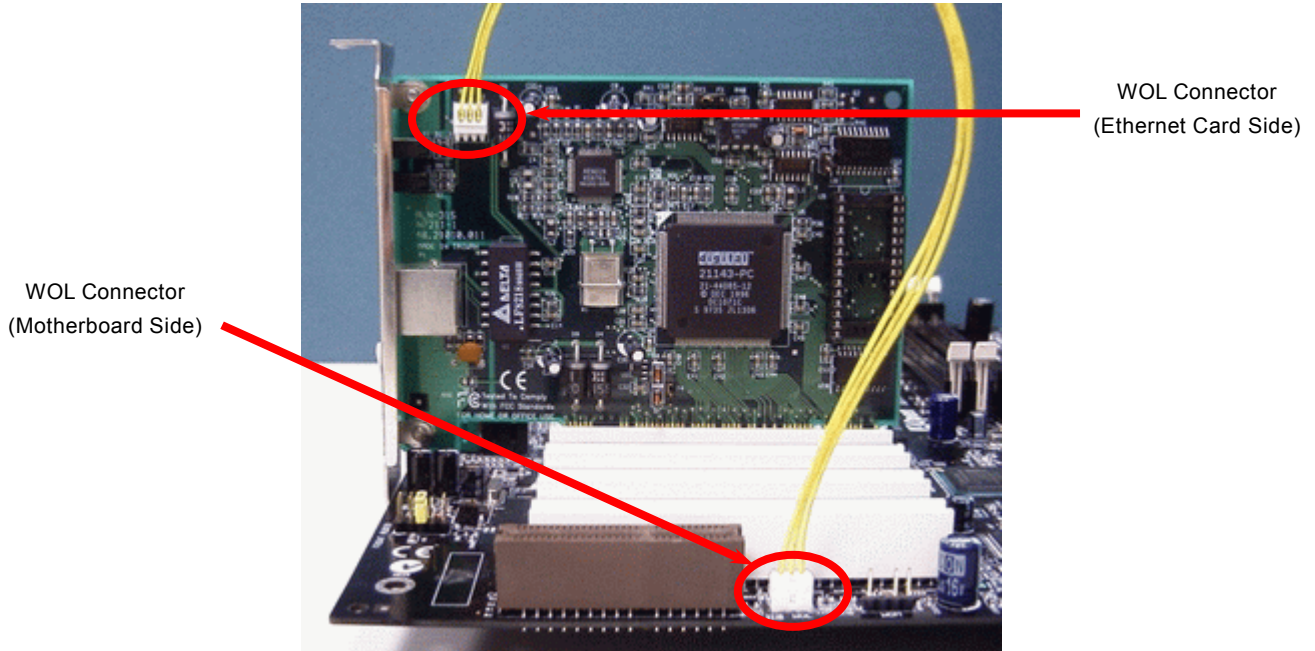

Note: This picture is for example only, it may not exactly be the same motherboard.

AGP (Accelerated Graphic Port) 4X Expansion Slot

The AK77-333F / AK77-333FN provides an [AGP](#) 4x slot. The AGP 8x is a bus interface targeted for high-performance 3D graphic. AGP supports only memory read/write operation and single-master single-slave one-to-one only. AGP uses both rising and falling edge of the 66MHz clock, for 4X AGP, the data transfer rate is $66\text{MHz} \times 4\text{bytes} \times 4 = 1056\text{MB/s}$. This AGP expansion slot is for 1.5V - 1.6V AGP card only.

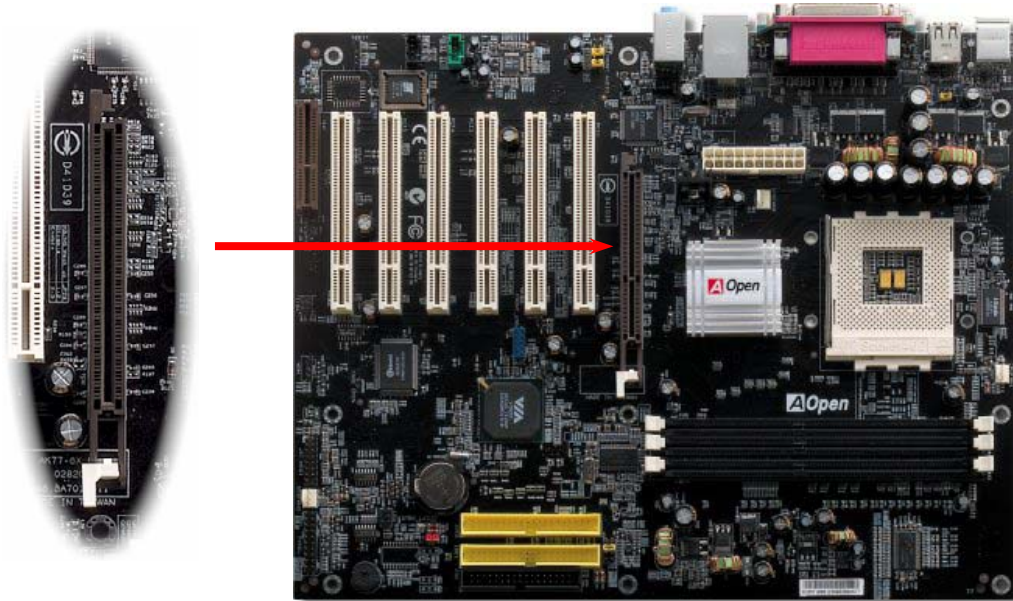

AGP Protection Technology and AGP LED

With the outstanding R&D ability of AOpen and its specially developed circuit, this model implements a blend new technology to protect your motherboard from being damaged by over-voltaging of AGP card. When AGP Protection Technology is implemented, this motherboard will automatically detect the voltage of AGP card and prevent your chipsets from being burnt out. Please note that if you install a AGP card with 3.3V, which is not supported, the AGP LED on the motherboard will light up to warn you the possible damage of the exceeding voltage. You may contact your AGP card vendor for further support.

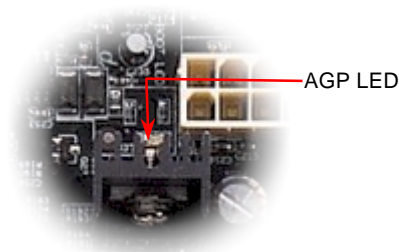

Warning: It is strongly recommended not to install a 3.3V AGP card, which is not supported. When you do so, the AGP LED on the motherboard will light up to warn you the possible damage.

CNR (Communication and Network Riser) Expansion Slot

[CNR](#) is a riser card specification to replace the [AMR \(Audio/Modem Riser\)](#) that supports V.90 analog modem, multi-channel audio, and phone-line based networking. Owing to CPU computing power getting stronger, the digital processing job can be implemented in main chipset and share CPU power. The analogy conversion ([CODEC](#)) circuit requires a different and separate circuit design, which is put on CNR card. This motherboard implements sound CODEC on board, but reserve CNR slot for the option of modem function. Note that you can still use PCI modem card.

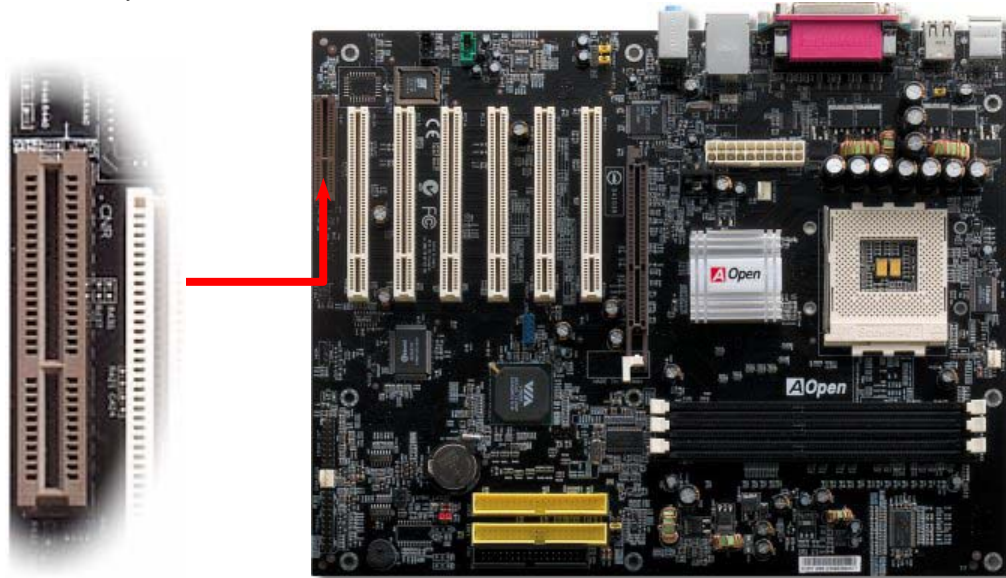

PC99 Color Coded Back Panel

The onboard I/O devices are PS/2 Keyboard, PS/2 Mouse, serial ports COM1 and COM2, RJ45 LAN Jack (AK77-333FN only), Printer, [USB](#), AC97 sound and game port. The view angle of drawing shown here is the back panel of the housing.

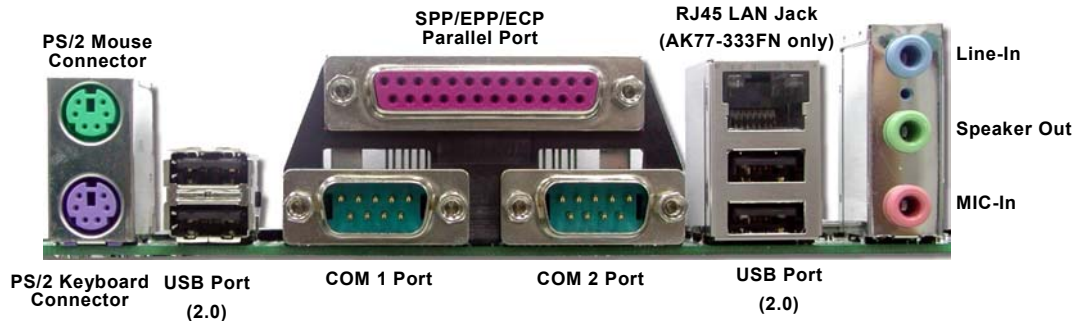

- PS/2 Keyboard:** For standard keyboard, which is using a PS/2 plug.
- PS/2 Mouse:** For PC-Mouse, which is using a PS/2 plug.
- USB Port:** Available for connecting USB devices.
- Parallel Port:** To connect with SPP/ECP/EPP printer.
- COM1 Port:** To connect with pointing devices, modem or others serial devices.
- Speaker Out:** To External Speaker, Earphone or Amplifier.
- Line-In:** Comes from the signal sources, such as CD/Tape player.
- MIC-In:** From Microphone.
- MIDI/Game Port:** For 15-pin PC joystick, game pad or MIDI devices.

Support Six USB 2.0 Port

This motherboard provides six [USB](#) ports to connect USB devices, such as mouse, keyboard, modem, printer, etc. There are four connectors on the PC99 back panel. You can use proper cables to connect the other USB connectors to the USB modules or front panel of chassis. Please note that USB 2.0, with fancy speed up to 480Mbps, is 40 times faster than the traditional ones. Except for the speed increase, USB 2.0 supports old USB 1.0/1.1 software and peripherals, offering impressive and even better compatibility to customers.

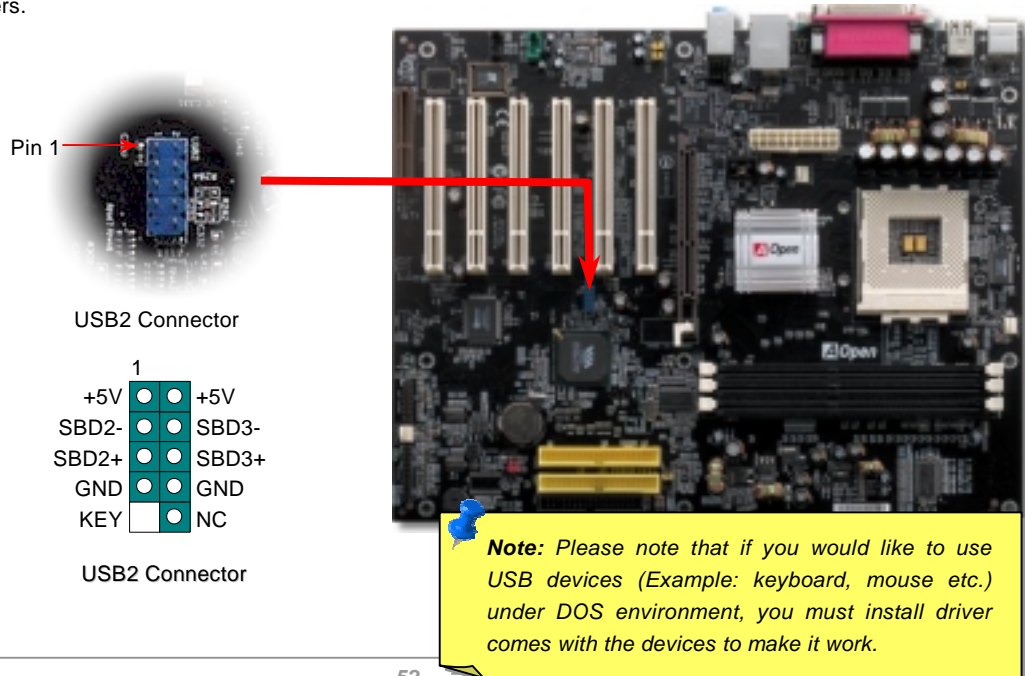

Support 10/100 Mbps LAN onboard (AK77-333FN only)

The South Bridge VT8235 includes a fast Ethernet controller on chip. On the strength of RealTek RTL8100BL LAN controller on board, which is a highly-integrated Platform LAN Connect device, it provides 10/100M bps Ethernet for office and home use, the Ethernet RJ45 connector is located on top of USB connectors. The green LED indicates the link mode, it lights when linking to network and blinking when transferring data. The orange LED indicates the transfer mode, and it lights when data is transferring in 100Mbps mode. To enable or disable this function, you may simply adjust it through BIOS.

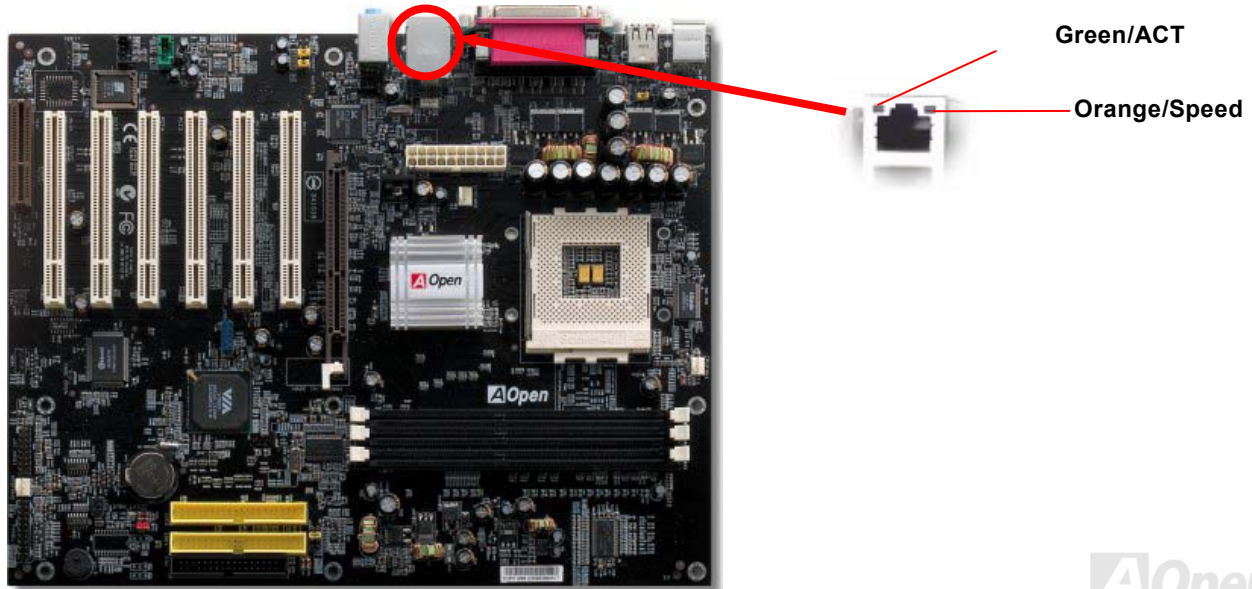

Chassis Intrusion Sensor

The “CASE OPEN” header provides chassis intrusion-monitoring function. To make this function works, you have to enable it in the system BIOS, connect this header to a sensor somewhere on the chassis. So, whenever the sensor is being triggered by light or opening of the chassis, the system will send out beep sound to inform you. Please be informed that this useful function only applies to advanced chassis, you may purchase an extra sensor, attach it on your chassis, and make a good use of this function.

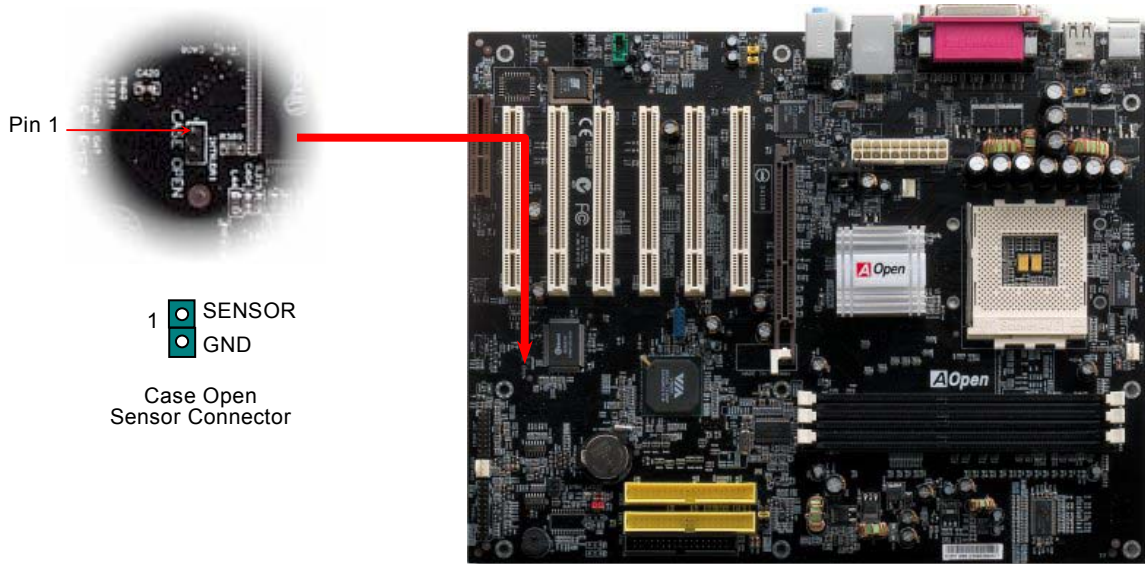

CD Audio Connector

This connector is used to connect CD Audio cable from CD-ROM or DVD drive to onboard sound.

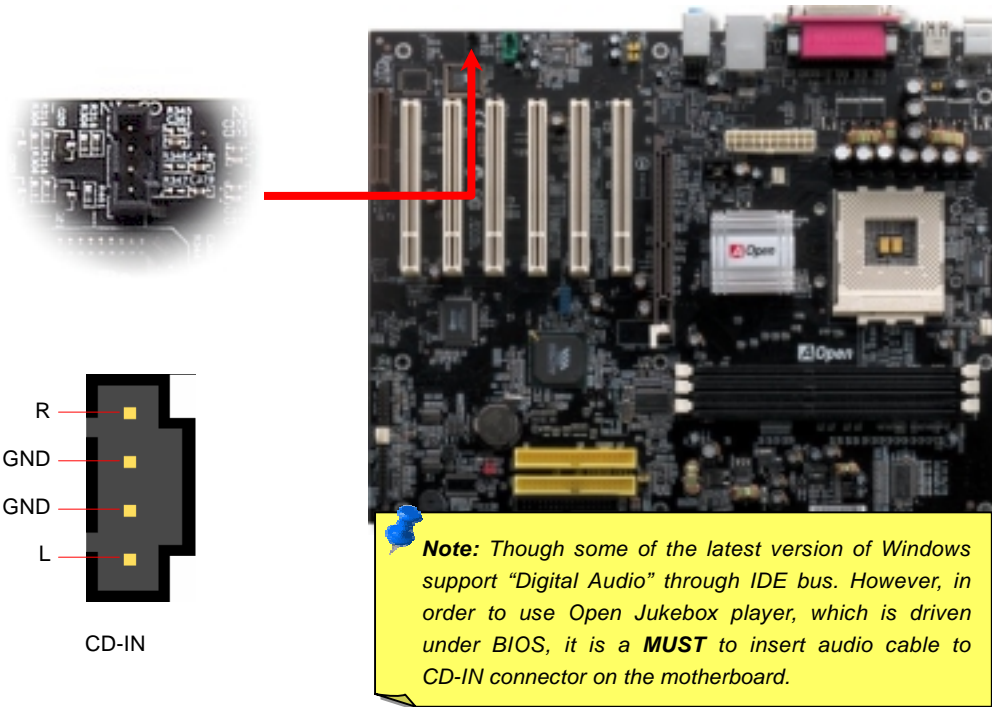

AUX-IN Connector

This connector is used to connect MPEG Audio cable from MPEG card to onboard sound.

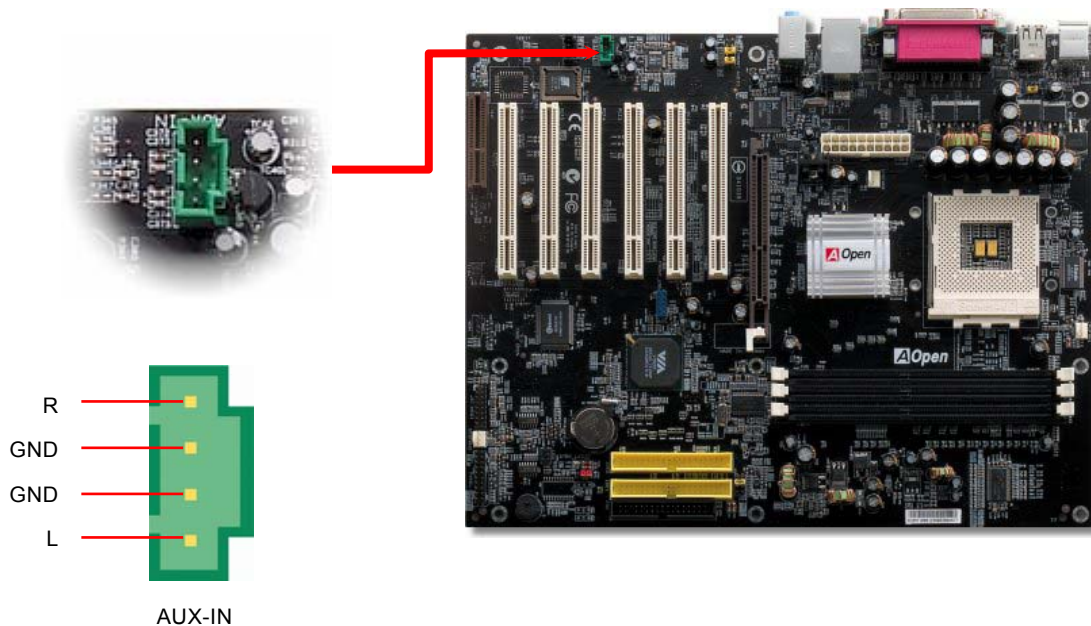

Front Audio Connector

If the housing has been designed with an audio port on the front panel, you'll be able to connect onboard audio to front panel through this connector. By the way, please remove 5-6 and 9-10 jumper caps from the Front Audio Connector before connecting the cable. Please do not remove these 5-6 and 9-10 yellow jumper caps if there's no audio port on the front panel.

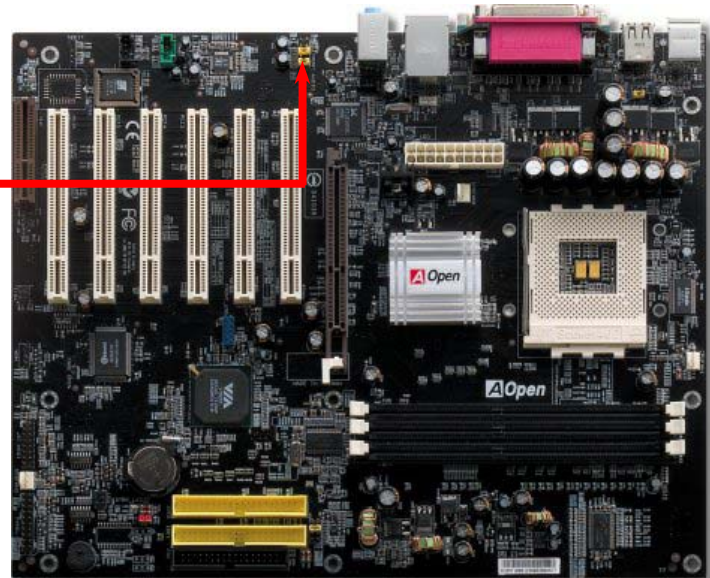
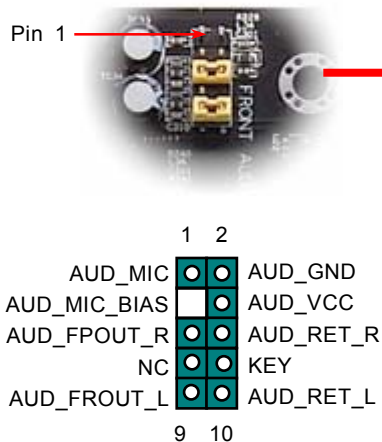

Battery-less and Long Life Design

This Motherboard implements [Flash ROM](#) and a special circuit that allows you to save your current CPU and CMOS Setup configurations without using the battery. The RTC (real time clock) can also keep running as long as the power cord is plugged. If you lose your CMOS data by accident, you can just reload the CMOS configurations from Flash ROM and the system will recover as usual.

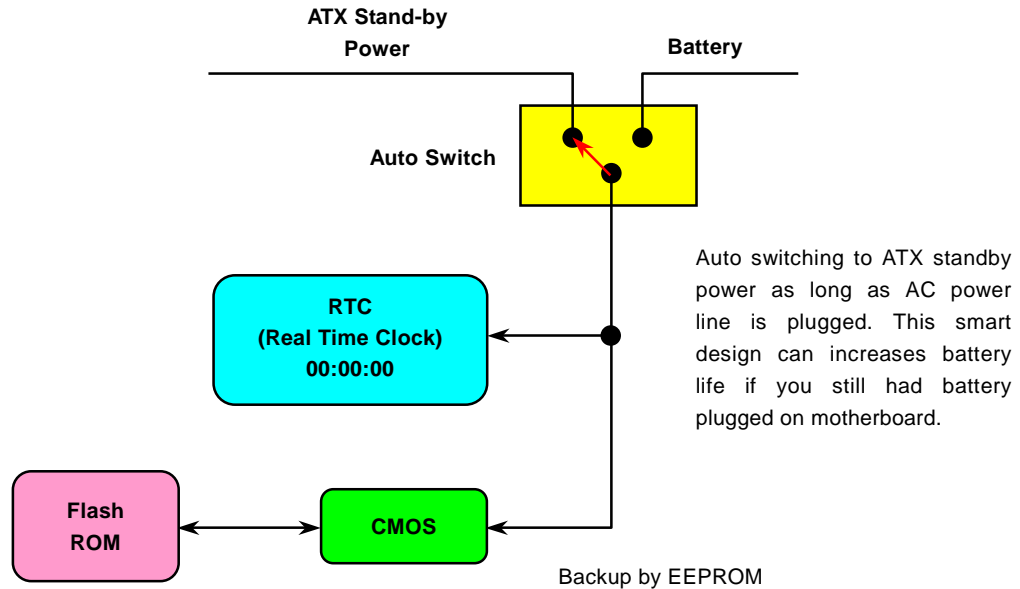

CPU Over-current Protection

Over Current Protection has been popularly implemented on ATX 3.3V/5V/12V switching power supply for a while. However, new generation CPU is able to use regulator of different voltages to transfer 12V to CPU voltage (for example, to 2.0V). This motherboard is with switching regulator onboard that supports CPU over-current protection, and it applies to 3.3V/5V/12V power supply for providing full line over-current protection.

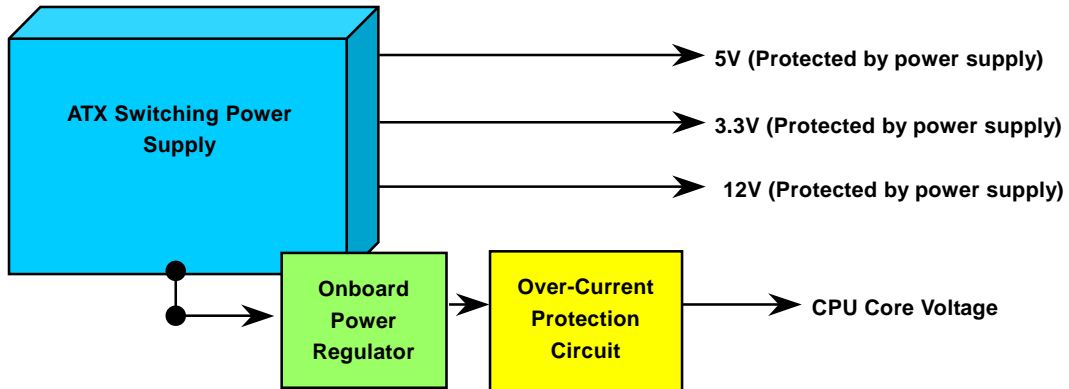

Note: Although we have implemented protection circuit try to prevent any human operating mistake, there is still certain risk that CPU, memory, HDD, add-on cards installed on this motherboard may be damaged because of component failure, human operating error or unknown nature reason. **AOpen cannot guaranty the protection circuit will always work perfectly.**

AOConfig Utility

NEW!

AOpen always dedicated to provide users a much friendlier computer environment. We now bring you a comprehensive system detective utility. AOconfig is a Windows based utility with user-friendly interface that allows users to obtain information of the operation system and hardware such as motherboard, CPU, memory, PCI devices and IDE devices. The powerful utility also displays the version of BIOS and firmware for your convenience of maintenance.

Moreover, AOconfig allows users to save information in *.BMP or *.TXT format which users may collect the system information in detail and send them to AOpen directly for technical support or further diagnosis of system problem.

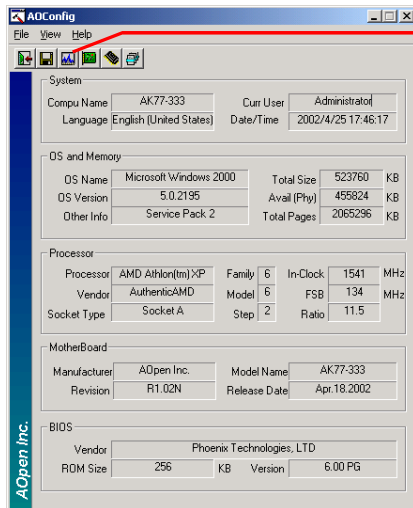

1. The system page shows the detail information of the motherboard, the operating system, the processor, and BIOS version.

2. The PCI device page shows the configurations of all PCI devices installed on your motherboard.

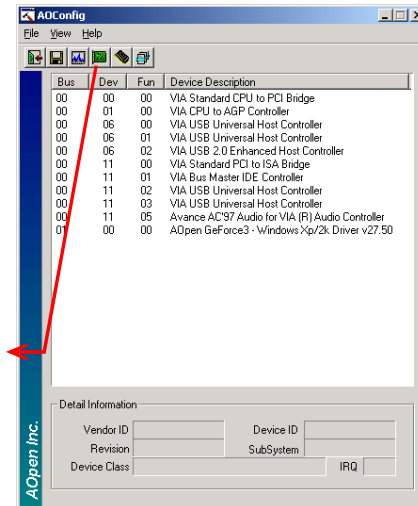

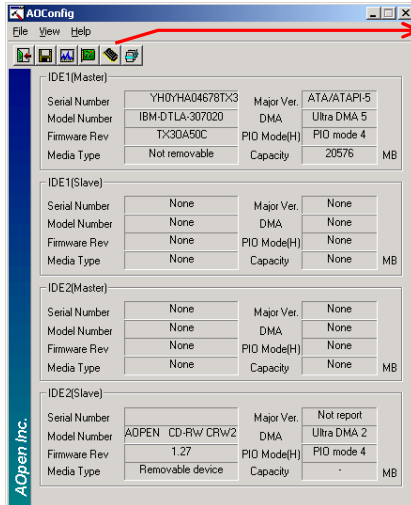

3. This page presents the IDE devices information, such as the serial number, the manufacturer, the firmware version, and capacity.

4. From this page, users may obtain the technical support information of AOpen. Moreover, detailed information could be saved in .bmp or .txt format.

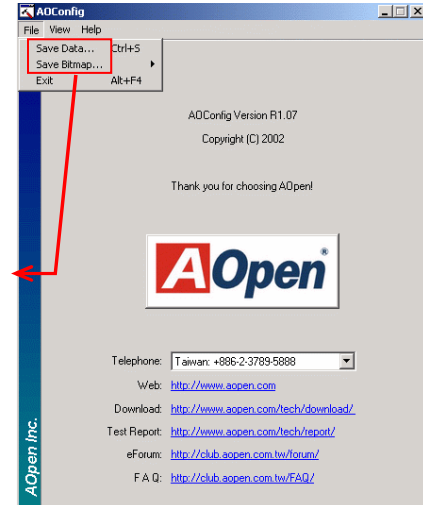

NOTE: AOconfig can be used in Windows 98SE/ME, NT4.0/2000, or even the latest Windows XP. Please be informed that AOconfig can only be operated in a system equipped with an AOpen motherboard. Meanwhile, all applications must be closed before starting AOconfig.

Resettable Fuse

Traditional motherboard has fuse for Keyboard and [USB](#) port to prevent over-current or shortage. These fuses are soldered onboard that user cannot replace it when it is damaged (did the job to protect motherboard), and the motherboard remains malfunction.

With expensive Resettable Fuse, the motherboard can resume back to normal function after fuse had done its protection job.

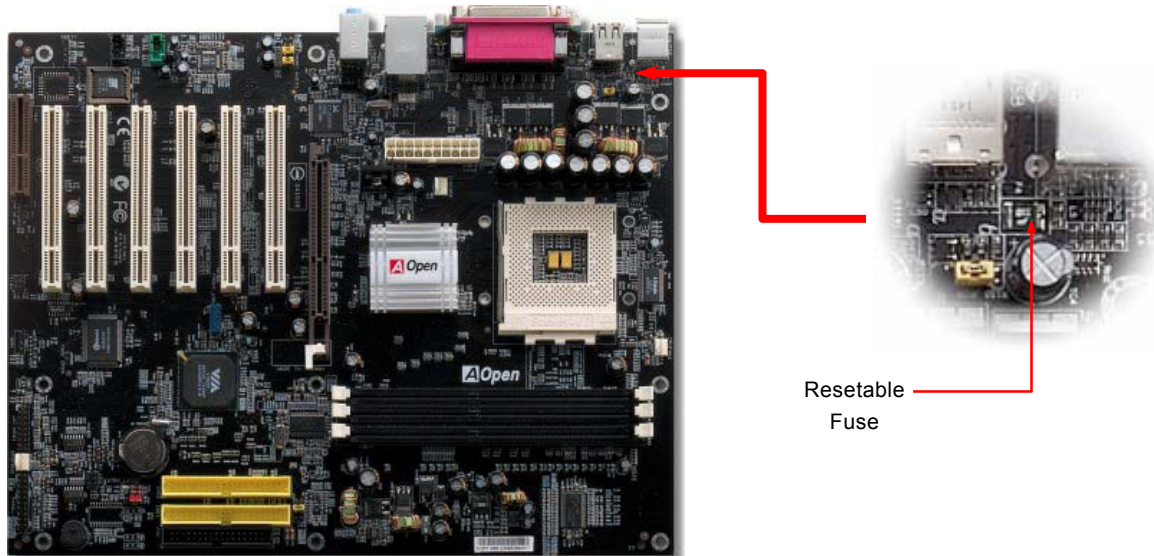

2200 μ F Low ESR Capacitor

The quality of low ESR capacitor (Low Equivalent Series Resistance) during high frequency operation is very important for the stability of CPU power. The idea of where to put these capacitors is another know-how that requires experience and detail calculation.

Not only that, this motherboard implements 2200 μ F capacitor, which is much larger than normal capacitor (1000 or 1500 μ F) and it provides better stability for CPU power.

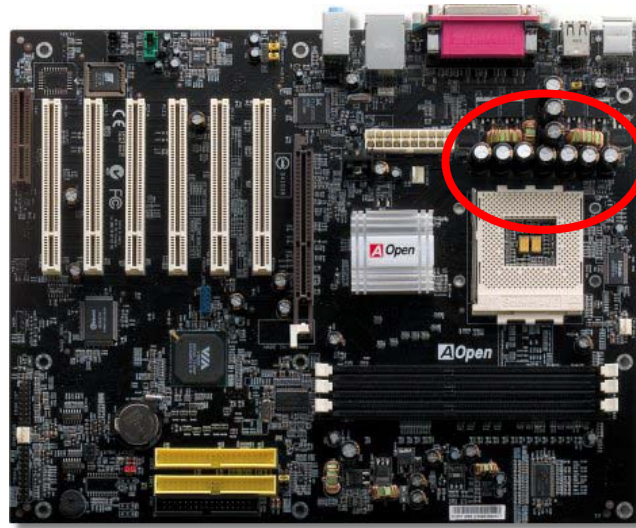

The power circuit of the CPU core voltage must be checked to ensure system stability for high speed CPUs (such as the new Pentium III, or when overclocking). A typical CPU core voltage is 2.0V, so a good design should control voltage between 1.860V and 2.140V. That is, the transient must be below 280mV. Below is a timing diagram captured by a Digital Storage Scope, it shows the voltage transient is only 143mV even when maximum 60 current is applied.

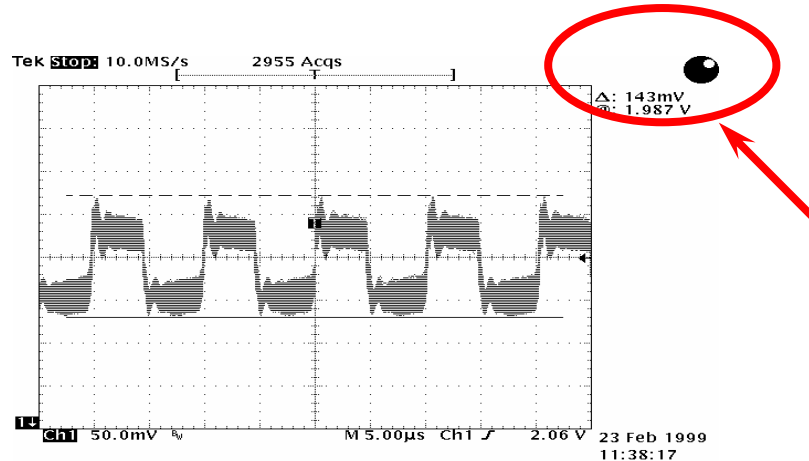

Note: This diagram for example only, it may not exactly be the same motherboard.

Layout (Frequency Isolation Wall)

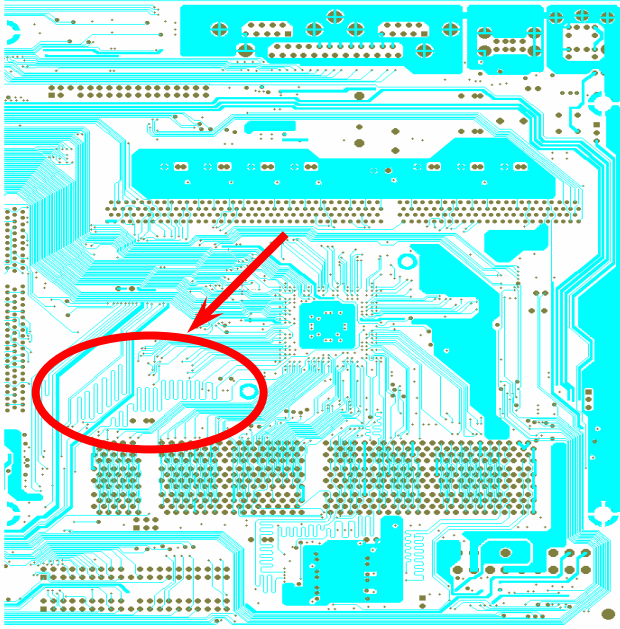

For high frequency operation, especially overclocking, layout is the most important factor to make sure chipset and CPU working in stable condition. The layout of this motherboard implements AOpen's unique design called " Frequency Isolation Wall". Separating each critical portion of motherboard into regions where each region operates in a same or similar frequency range to avoid cross talk and frequency interference between each region's operations and condition. The trace length and route must be calculated carefully. For example, the clock trace must be equal length (not necessarily as short as possible) so that clock skew will be controlled within few a pico second ($1/10^{12}$ Sec)

Note: This diagram is for example only, it may not exactly be the same diagram of this motherboard.

Enlarged Aluminum Heatsink

Cool down CPU and Chipset is important for system reliability. Enlarged aluminum heat sink provides better heat consumption especially when you are trying to over clocking the CPU.

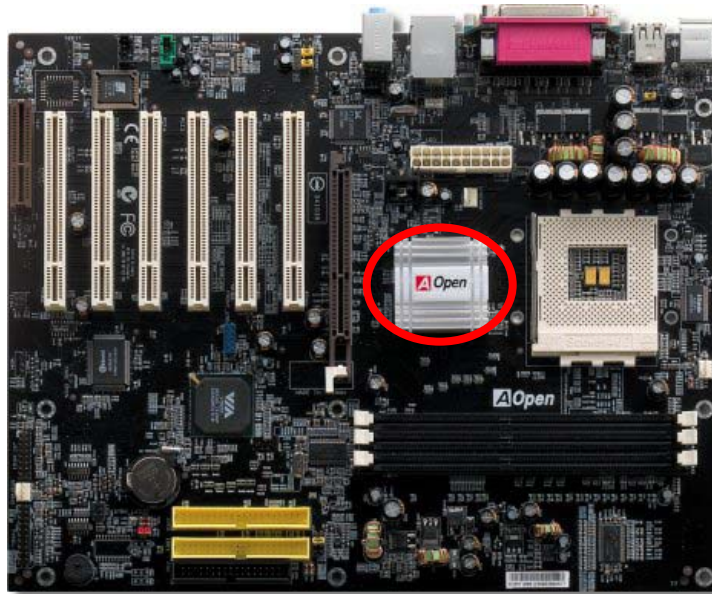

Open JukeBox Player



Here we are pleased to provide you a brand-new powerful interface—Open JukeBox. Without any cost you can have your PC turn into a fashionable CD player! This latest Open JukeBox motherboard aims at helping you directly operate your CD player on the PC without any hassle of entering Windows operation system.



How Your Open JukeBox Works

The operation of Open JukeBox Player is the same as other CD players. By pressing specific keys on the keyboard you will find playing Open JukeBox Player couldn't be easier than the traditional CD Players. Below is the function description of respective buttons.



Power: Pressing **O**, to directly power off your computer with no hassle of entering Windows Operation System.

Boot: Pressing **B**, to intelligently boot to Windows Operation System for you.

Play: Pressing **A**, to start playing CD music.

Stop: Pressing **S**, to stop the music playing.

Pause: Pressing **P**, to pause the music playing temporarily.

Eject: Pressing **E**, to eject CD tray for you to change CD disc.

Repeat: Like other CD Players, pressing **R**, to shift the repeat mode.

Volume +/-: Pressing **+** or **-** to adjust the volume of playing music.

Rewind/Forward **← / →**: Pressing **arrow keys**, to rewind or forward the music.

Note: Though some of the latest version of Windows support "Digital Audio" through IDE bus. However, in order to use Open Jukebox player, which is driven under BIOS, it is a **MUST** to insert audio cable to CD-IN connector on the motherboard.

Your Open JukeBox Settings in BIOS

There are three Open JukeBox settings in BIOS as follows.

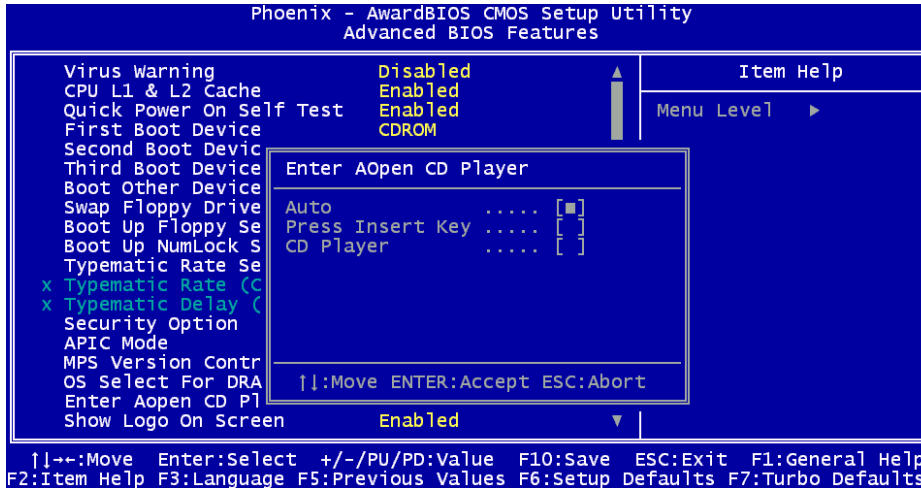

Auto: The default setting is “Auto” with which the Open JukeBox will automatically check the CD player every time you power on. The Open JukeBox will automatically be launched when it detects a music CD in your CD player.

Press Insert Key: Choosing this setting will allow a reminder message popped up on the screen during BIOS POST. It reminds you of pressing “Ins” key on your keyboard to start Open JukeBox Player; otherwise the system will launch the Windows Operation System.

CD Player: Choosing this setting allows the system to launch Open JukeBox Player every time you power on. However, by pressing **B** on your keyboard the Windows Operation System will be launched.

Your Open JukeBox EzSkin



Except these powerful functions above, Open JukeBox Player is also equipped with another fancy feature for you to change its “skin”. You can download as many skins as you want from AOpen Website, and changing them whenever you want by using this useful utility – **EzSkin** – which may also be downloaded from our website.

Even more, you may design your own skins with innovative idea and sharing them to users around the world by uploading to our website. For further technical information, we welcome you to visit our website at <http://english.aopen.com.tw/tech/download/skin>



Vivid BIOS technology



Have you been fed up with the conservative and immutable POST screen? Let's rule out the tradition idea that POST screen are stiff and frigid, and let AOpen show you the newly developed VividBIOS to experience the lively vivid colorful POST screen!

Unlike earlier graphic POST screen, which could occupy the whole screen and mask text information during POST, AOpen VividBIOS deals with graphics and texts separately, and makes them running simultaneously during POST. With this innovative design, VividBios now brings you a beautiful and sleek 256 colors screen without missing any important information shown on POST screen.

In addition, the limited space of BIOS ROM is another big issue. When all of the traditional BIOS can only show space-consuming and uncompressed Bitmap, AOpen has considerably tuned the BIOS to next generation, to recognize the smaller-sized GIF format and even dynamic-showing GIF animation.



Vivid BIOS shares the same fundamental technology with Open JukeBox CD Player, you may use the same EzSkin utility to

change your Vivid BIOS screen or to download your favorite Open JukeBox skin. If you see this little logo  shown beside your model name on the BIOS download page, <http://english.aopen.com.tw/tech/download/skin>, it is assured that your motherboard supports this innovative feature!

Driver and Utility

There are motherboard drivers and utilities included in [AOpen Bonus CD disc](#). You don't need to install all of them in order to boot your system. But after you finish the hardware installation, you have to install your operation system first (such as Windows 98) before you can install any drivers or utilities. Please refer to your operation system's installation guide.



Note: Please follow recommended procedure to install [Windows 95](#) and [Windows 98](#).

Auto-run Menu from Bonus CD Disc

You can use the auto-run menu of Bonus CD disc. Choose the utility and driver and select model name.

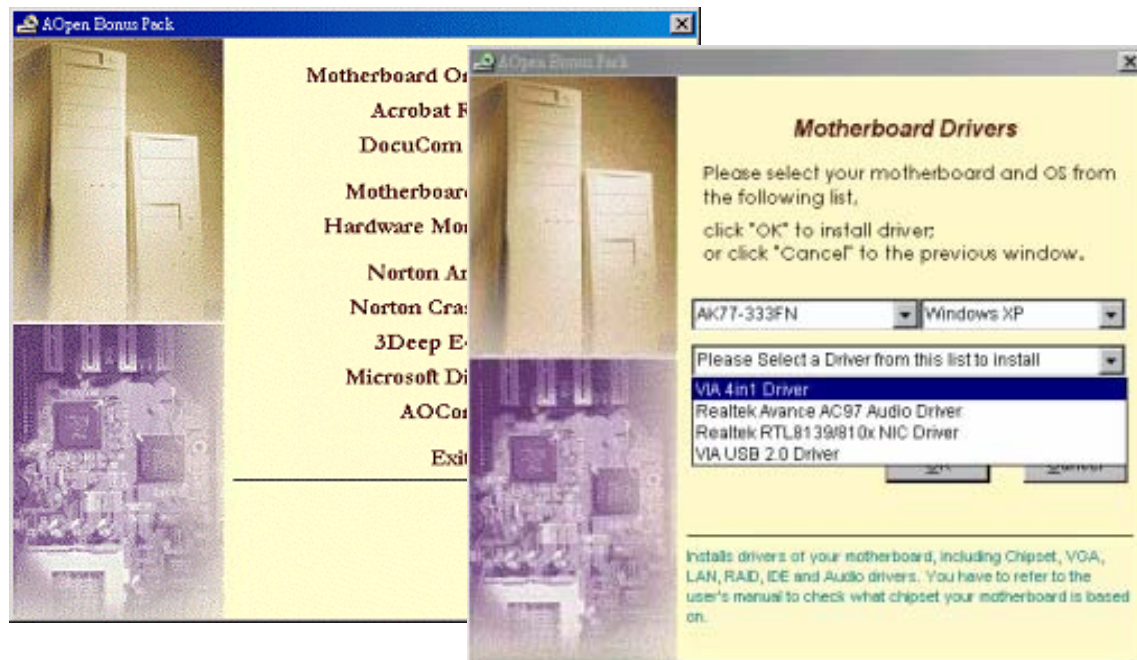

Installing Windows 95

1. First, don't install any add-on card except [AGP](#) card.
2. Install Windows 95 OSR2 v2.1, 1212 or 1214 version and later with USB support. Otherwise, you need to install USBSUPP.EXE.
3. Install the [VIA 4 in 1 driver](#), which includes VIA AGP Vxd driver, VIA ATAPI Vendor Support driver and VIA registry (INF) program.
4. Finally, Install other add-on cards and their drivers.

Installing Windows 98

1. First, don't install any add-on card except [AGP](#) card.
2. Enable USB Controller in BIOS Setup > Advanced Chipset Features > OnChip USB, to make BIOS fully capable of controlling IRQ assignment.
3. Install Window 98 into your system.
4. Install the [VIA 4 in 1 driver](#), which includes VIA AGP Vxd driver, IRQ Routing, VIA ATAPI Vendor Support driver and VIA registry (INF) program.
5. Finally, Install other add-on cards and their drivers.

Installing Windows® 98 SE, Windows® ME & Windows® 2000/XP

If you are using Windows® 98 Second Edition, Windows® Millennium Edition or Windows® 2000/XP, you do not need to install the 4-in-1 driver as the IRQ Routing Driver and the ACPI Registry are already incorporated into the operating system. Users with Windows® 98 SE may update the VIA Registry INF and AGP drivers by installing them individually.

Please refer to [VIA Technologies Inc.](http://www.via.com/) for latest version of 4 in 1 driver:

<http://www.via.com/>

<http://www.via.com/drivers/4in1420.exe>

Installing VIA 4 in 1 Driver

You can install the VIA 4 in 1 driver ([IDE Bus master](#) (For Windows NT use), VIA ATAPI Vendor Support Driver, VIA [AGP](#), IRQ Routing Driver (For Windows 98 use), VIA Registry (INF) Driver) from the Bonus Pack CD disc auto-run menu.

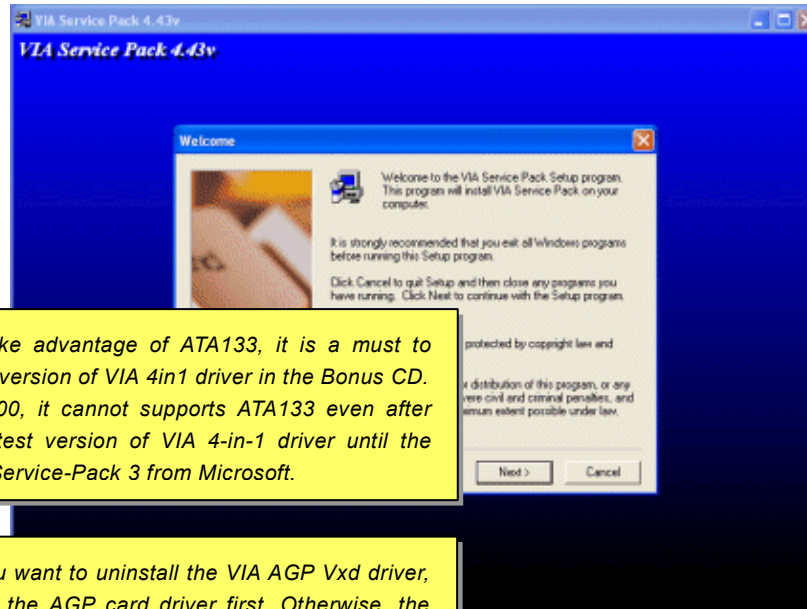

Warning: To take advantage of ATA133, it is a must to install the latest version of VIA 4in1 driver in the Bonus CD. For Windows2000, it cannot support ATA133 even after installing the latest version of VIA 4-in-1 driver until the new release of Service-Pack 3 from Microsoft.

Warning: If you want to uninstall the VIA AGP Vxd driver, please remove the AGP card driver first. Otherwise, the screen may go black at rebooting after the un-installation.

Installing Onboard Sound Driver

This motherboard comes with RealTek ALC650 [AC97 CODEC](#) and the sound controller is in VIA South Bridge chipset. You can find the audio driver from the Bonus Pack CD disc auto-run menu.

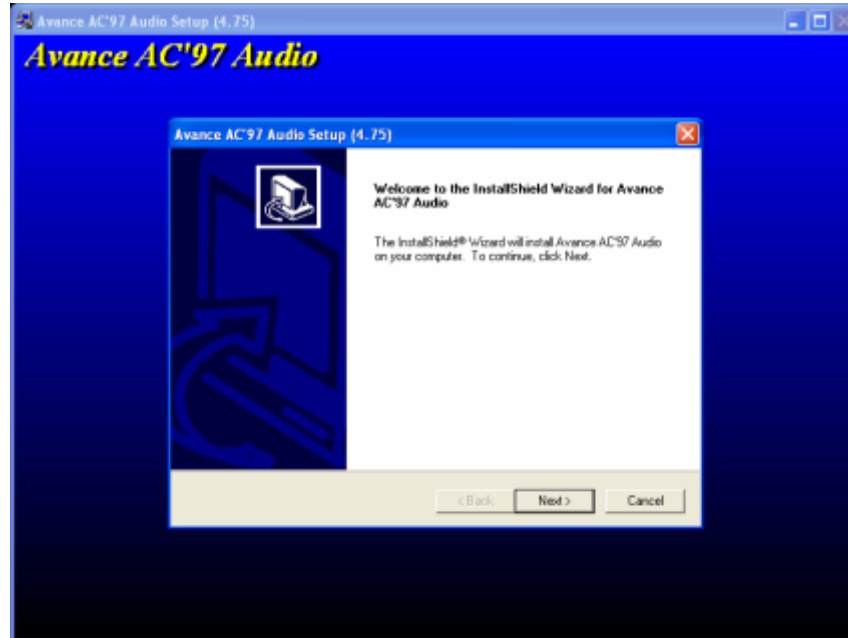

The noise is gone!! ---- SilentTek



As the clock of CPU keeps rocketing higher and higher, it inevitably brings higher heat and system temperature in a relative way. The way we deal with this heat problem, however, is to spare no effort to add one fan after another to protect our pampered system, expecting these fans could cool down our machine as much as it could.

But at the same time, we believe that same amount of users are affected terribly while working with their PC by the irritating noises of these fans. As a matter of fact, we do not have to get our fans running at such a high speed in most cases; on the contrary, we discovered that having your fans running at appropriate time and speed could not only reduce the noise, but also

consume the least power the system needed, so as to prevent over-wasting of energy resource.

Today, AOpen Motherboard is honored to bring you a new overall solution, SilentTek, to have your system quiet. To collocate with hardware circuit, BIOS and the utility under Windows, SilentTek combined "Hardware-Status Monitoring", "Overheat Warning" and "Fan Speed Control" with user-friendly interfaces to provide you a perfect balance between noises, system performance and stability.

Phoenix - AwardBIOS CMOS Setup Utility
Silent PC/PC Health Status

CPU Warning Temp.	60° C/140° F	↑	Item Help
CPUFan1 Boot Speed	70% 3150 RPM		Menu Level ▶
SYSFan2 Boot Speed	70% 3500 RPM		This is fan control mode during POST and Open Jukebox, after exiting the Jukebox, the fan will be set to Fan OS Speed.
CPUFan1 OS Speed	100% 4500 RPM		[Full Speed]
SYSFan2 OS Speed	100% 5000 RPM		Run in full speed.
Fan Mode	Smart Control		[Smart Control]
x CPUFan1 Fixed Speed	100% 4500 RPM		According to the safety temperature you set below, fan speed will be controlled as slow as possible.
x SYSFan2 Fixed Speed	100% 5000 RPM		
CPU Set Temp.	40° C		
SYS Set Temp.	30° C		
CPU Kernel Temp.	69° C/156° F		
CPU Temp.	47° C/116° F		
SYS Temp.	31° C/107° F		
CPUFAN1 Speed	4500 RPM		
SYSFAN2 Speed	5000 RPM		
SYSFAN3 Speed	5532 RPM		
Vcore(V)	1.48 V		

↑↓←→:Move Enter:Select +/-/PU/PD:Value F10:Save ESC:Exit F1:General Help
F2:Item Help F5:Previous Values F6:Setup Defaults F7:Turbo Defaults

The first image you have here is the Voltage Status page. You can find current status of all voltages and set your expected margins of warning level.

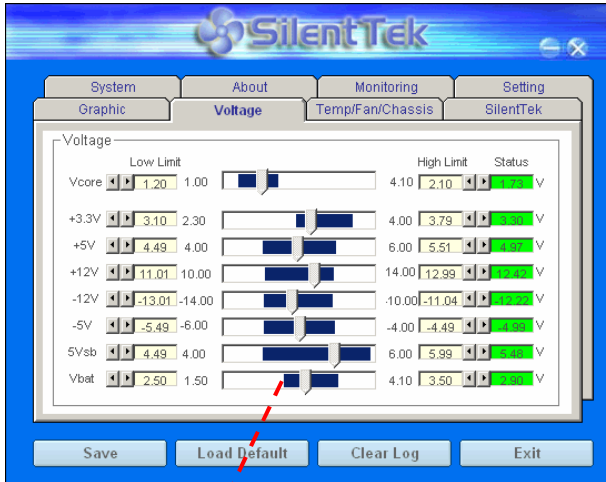

You may check your system voltage from the indicating bar here.

In "Temp/Fan/Case" page, you may get aware of the current temperature of CPU and the heat inside chassis, plus checking if fans are running properly.

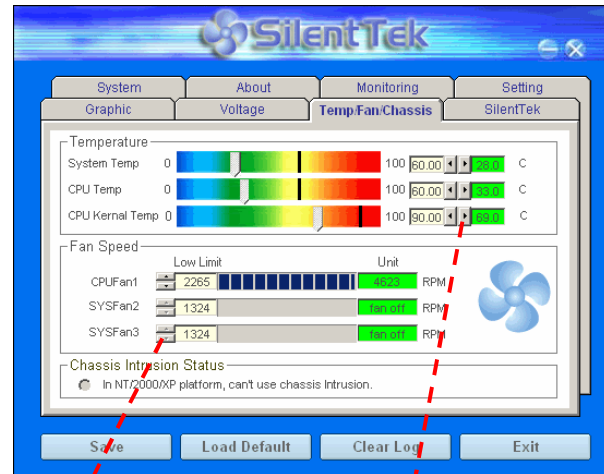

Of course, you may set your defaulted lowest margin for your fans and the SilentTek would also pop up a message box and alarm you when the fan is rotating slower than this specified speed.

You may set the highest margin of your CPU and system temperature as default, and SilentTek would pop up a message box and alert you with alarm when the temperature goes beyond the specified margin.

The following page is sure to be the most important part of this utility, you may control the rotation speed of specific fans you got with options inside in this page. Respectively illustrate as follow:

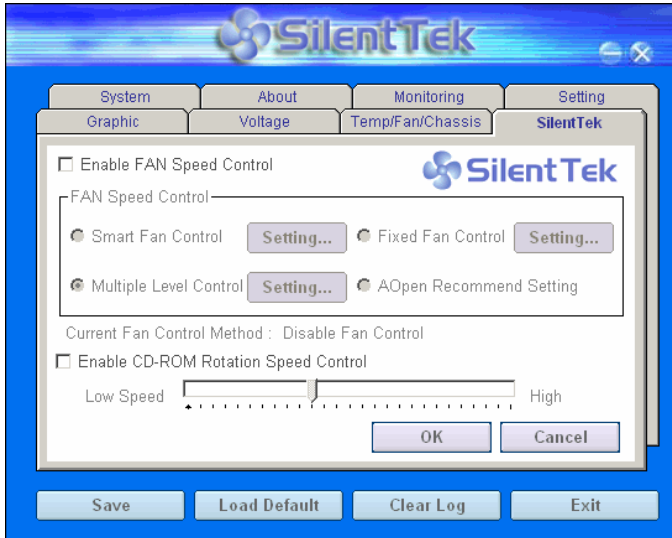

1. **Smart FAN Control:** This is the default setting of SilentTek and can be used for any branded computer housing. With a special algorithm developed by AOpen, the fan speed is automatically adjusted by the factors of CPU and ambient temperature. Ease-of-use and trouble free at your service.
2. **Fixed FAN Control:** Under this setting, a desired fan speed is set fixed when operating.
3. **Multiple Level Control:** This is the most versatile setting that allows you to set fan speed in relation to temperature. You may find this setting fits youbest.
4. **AOpen Recommend Setting:** This setting is designed specifically for AOpen housing. A series of lab tests were conducted under the real world scenario to determine optimum fan speed to reduce noise level within CPU working condition and temperature. Most of the time, the fan would remain still when CPU is not fully utilized.

Note: Due to there are hundreds different brands of fan on the market, there might be some inaccuracy occurred when you have had adjusted your rotation speed; this is still under criterion and please assured that it won't cause any problem to your system.

Installing USB2.0 Driver

This motherboard comes with USB2.0 function. You can install USB2.0 Driver under Windows 98SE, Windows ME, Windows 2000 and Windows XP from the Bonus Pack CD disc auto-run menu.



Note: After installing USB 2.0 driver under WinME, there would be a "green question mark" on "VIA USB 2.0 Enhanced Host Controller" item. Please rest assured that it is not an error message. You may just ignore it.

Installing LAN Driver (AK77-333FN only)

You can install LAN Driver for Win98, 98SE, 98ME, 2000 and XP with this InstallShield Wizard from the Bonus Pack CD disc auto-run menu.

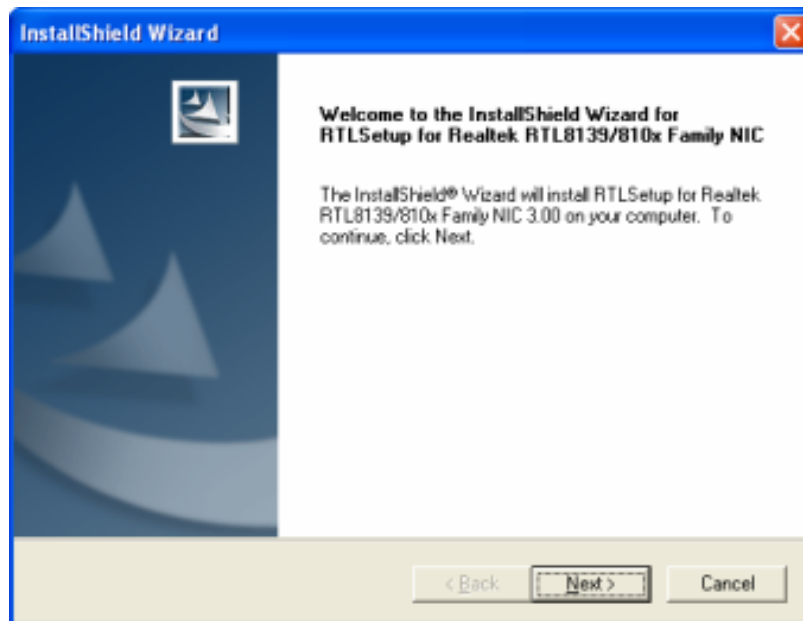

Introduction:

This document describes the procedure to install **Windows 95** (Golden version), Win95A, OSR2, Windows NT v4.0 driver for Realtek RTL8139 PCI Fast Ethernet adapter.

[Windows 95 (Golden version), Win95A and OSR2]

Installing driver procedure on Microsoft Windows 95 :

1. Ask you to select which driver you want to install, select "Driver from disk provided by hardware manufacturer".
2. Specify the setup file pathname
[CD-ROM]:\Driver\LAN\RTL8100\Windows\95\WIN95A (for Windows 95 and Win95A) or
[CD-ROM]:\Driver\LAN\RTL8100\Windows\95\W95OSR2 (for Windows 95 OSR2).
3. Windows 95 will appear some messages to insert Windows 95 system disk to complete setup step.
4. Windows 95 will finish the other installation procedure automatically, then you restart the system.

[Windows NT 3.5, 3.51 & 4.0]

Installing driver procedure on Microsoft **Windows NT** :

When you are in Windows NT :

1. In the Main group of NT, select the "Control Panel" icon.
2. In the Control Panel window, choose the "Network" icon.
3. In the Network Settings dialog box, choose the "Add Adapter" button.
The Add Network Adapter dialog box appears.
4. In the list of network cards, select "<other> Requires disk from manufacturer", and then press <Enter> button.
5. Enter drive and pathname
[CD-ROM]:\Driver\LAN\RTL8100\Windows\NT (for NT 4.0) which is the path where the setup file OEMSETUP.INF is located, and then choose the OK button.
6. The screen will appear "Select Line Speed" dialog box which is provide by RTL8139.SYS driver. The default value is "auto" so that the RTL8139 PCI Fast Ethernet adapter and its driver RTL8139.SYS will auto-detect the line speed, 10 Mb or 100Mb, while the RTL8139.SYS is loading. The other values, "10" or "100", are only used when you want to forced RTL8139 PCI Fast Ethernet adapter to 10Mb or 100Mb.
7. The screen will appear "Input EthernetID" dialog box which is provide by RTL8139.SYS driver. This option is only required when you have more than one Realtek RTL8139 PCI Fast Ethernet adapters on this computer. Select "SKIP" if only one adapter is installed on this computer.

8. "Bus Location" display in next screen. Your machine contains more than one hardware bus, please select the Bus Type and Bus number on which your network adapter card is installed.
9. NT will then perform the binding process. If any additional network software options were installed, you may be prompted for specific information for these packages.
10. Restarting your system you will acquire network service.

NOTES:

*** Installing Multiple LAN Adapters:**

Enter Windows NT and follow above setup procedure step 2, in the "Network Settings" dialog box, choose the "Configure.." button. The "Input Ethernet ID" dialog box appears and input adapter's Ethernet ID. Last step to select OK and close NETWORK SETUP. Select SKIP if only one adapter is installed on this computer.

PHOENIX-AWARD BIOS

System parameters can be modified by going into [BIOS](#) Setup menu, this menu allows you to configure the system parameters and save the configuration into the 128 bytes CMOS area, (normally in the RTC chip or in the main chipset).

The Phoenix-Award BIOS™ that installed in the [Flash ROM](#) of the motherboard is a custom version of an industry standard BIOS. The BIOS provides critical low-level support for standard devices such as hard disk drives, serial and parallel ports.

Most BIOS setting of AK77-333F / AK77-333FN had been optimized by AOpen's R&D engineering team. But, the default setting of BIOS still can't fine-tune the chipset controlling entire system. Hence, the rest of this chapter is intended to guide you through the process of configuring your system using setup.

Currently there are two kinds of beep sound when system fails to boot at POST. The first type of beep sound consists of a single long beep and two short beeps, indicating a video error has failed BIOS from initializing video screen for displaying any additional information. The 2nd type of beep sound is a single long beep that beeping repeatedly, signaling a DRAM error has occurred. You may look over the indicated error according to different beep significances.

[To enter to BIOS setup menu](#), press when [POST \(Power-On Self Test\)](#) screen is shown on your monitor.

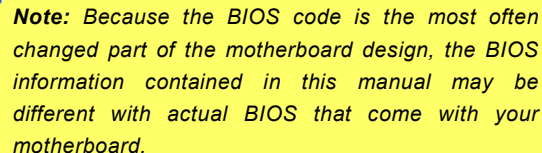

Note: *Because the BIOS code is the most often changed part of the motherboard design, the BIOS information contained in this manual may be different with actual BIOS that come with your motherboard.*

How To Use Phoenix Award™ BIOS Setup Program

Generally, you can use the arrow keys to highlight items that you want to choose, then press <Enter> key to select, and use the <Page Up> and <Page Down> key to change setting value. You also can press <F1> key for help and press <Esc> key to quit Phoenix Award™ BIOS setup program. The following table provides details about how to use keyboard in the Phoenix Award™ BIOS setup program. By the way, all products of AOpen also provides a special function in the BIOS setup, you can press <F3> key selecting preferred menu language to display.

Key	Description
Page Up or +	Changing setting to next value or increase the value.
Page Down or -	Changing setting to previous value or decrease value.
Enter	Select the item.
Esc	1. In main menu: Quit and don't save any change. 2. In sub menu: Exit current menu to main menu.
Up Arrow	Highlight previous item.
Down Arrow	Highlight next item.
Left Arrow	Move the light bar to left side of menu.
Right Arrow	Move the light bar to right side of menu.
F1	Get menu or item help description.
F3	Changing menu language.
F5	Load previous setting value from CMOS.

Key	Description
F6	Load Setup Defaults setting value from CMOS.
F7	Load turbo setting value from CMOS.
F10	Save changed setting and exit setup program.

How To Enter BIOS Setup

After you finish the setting of jumpers and connect correct cables. Power on and enter the BIOS Setup, press during POST (Power-On Self Test). Choose "Load Setup Defaults" for recommended optimal performance.

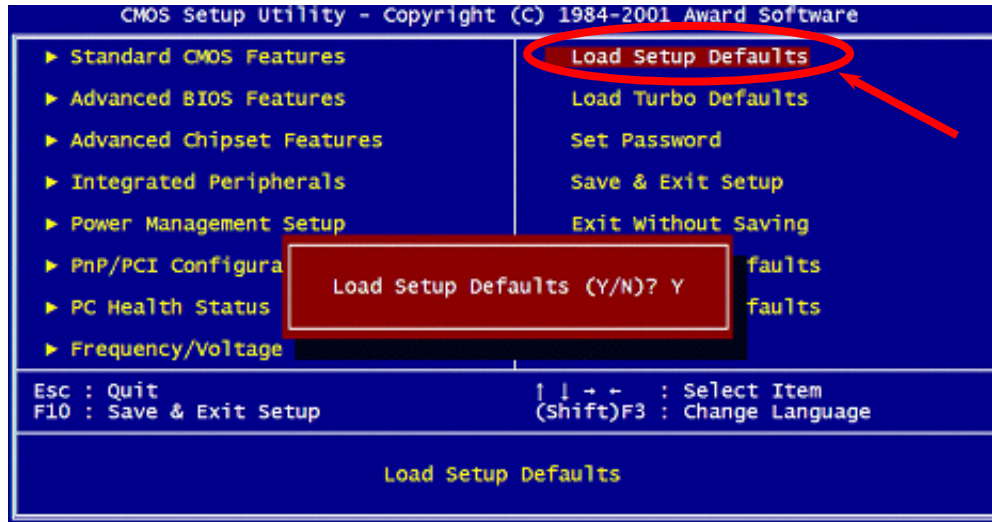

Warning: Please avoid of using "Load Turbo Defaults", unless you are sure your system components (CPU, SDRAM, HDD, etc.) are good enough for turbo setting.



BIOS Upgrade under Windows environment



With outstanding R&D ability of AOpen, we now bring you a whole new BIOS Flash wizard ---- EzWinFlash. With an eye to users convenience, EzWinFlash combines the BIOS binary code and flash module together, so the only thing you have to do is just clicking on the utility you downloaded from web and let it helps you complete the flash process automatically. EzWinFlash detects your motherboard and checks the BIOS version cleverly to prevent your system from any possible failure. Moreover, EzWinFlash has been taken into consideration to go with any windows platform you might be using, no matter if you're using Windows 95/98, 98SE/ME, NT4.0/2000, or even the latest Windows XP.

In the meanwhile, in order to provide a much more user-friendly operating environment, AOpen EzWinFlash is natively designed to have multi-language function to provide easier way for users' usage in changing BIOS setting.

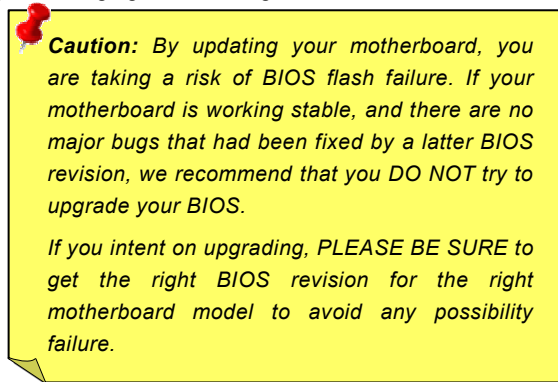
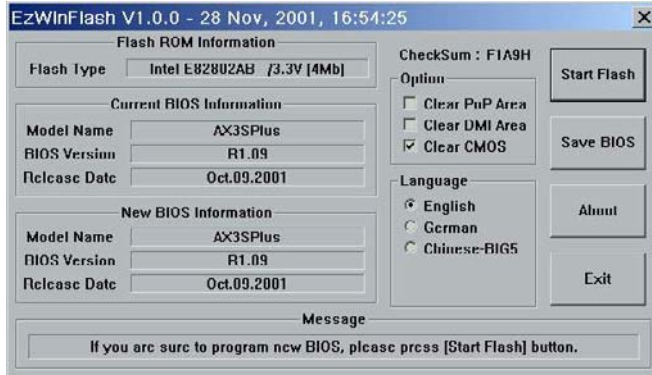

Note: The model name on this BIOS picture is for reference only. It may not be the exact model name.

You may accomplish BIOS upgrade procedure with EzWinFlash by the following steps, and it's STRONGLY RECOMMENDED to close all the applications before you start the upgrading.

1. Download the new version of BIOS package zip file from AOpen official web site. (ex: <http://english.aopen.com.tw/>)
2. Unzip the download BIOS package (ex: WAK77333FN02.ZIP) with WinZip (<http://www.winzip.com>) in Windows environment.
3. Save the unzipped files into a folder, for example, WAK77333FN02.EXE & WAK77333FN02.BIN.
4. Double click on the WAK77333FN02.EXE, EzWinFlash will detect the model name and BIOS version of your motherboard. If you had got the wrong BIOS, you will not be allowed to proceed with the flash steps.
5. You may select preferred language in the main menu, then click [Start Flash] to start the BIOS upgrade procedure.
6. EzWinFlash will complete all the process automatically, and a dialogue box will pop up to ask you to restart Windows. You may click [YES] to reboot Windows.
7. Press at POST to [enter BIOS setup](#), choose "Load Setup Defaults", then "Save & Exit Setup". Done!

It is strongly recommended NOT to turn off the power or run any application during FLASH PROCESS.

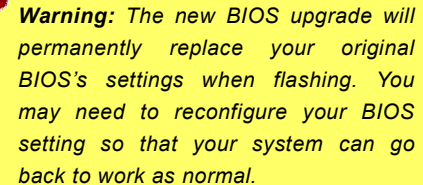

Warning: The new BIOS upgrade will permanently replace your original BIOS's settings when flashing. You may need to reconfigure your BIOS setting so that your system can go back to work as normal.

Overclocking

As a leading manufacturer in motherboard industry, AOpen always listens to what customers want and develop products to fit different user's requirements. Reliability, compatibility, leading technology and friendly features are our basic goals when designing motherboards. Other than above mentioned design criteria, there are power users who are always seeking to push the limitation of the system performance by overclocking who we call them "Overclocker".

This section is dedicated to overclockers.

This high performance motherboard is designed for maximum **133MHz** CPU bus clock. But it comes with clock generator of **248MHz** when we design it to accommodate future CPU bus clock. Our lab test results shown that **166MHz** is achievable when proper setting and qualified components were presented, we feel quite comfortable overclocking to **166MHz**. Not only that, this motherboard has full-range (CPU core voltage) settings and an option to adjust CPU core voltage. The CPU clock ratio can be up to 12.5x that supports almost all of Athlon / Duron / AthlonXP CPUs in the future and provides flexibility for overclockers. For your reference, the following configurations are what we feel comfortable at **166MHz** bus clock.

But not guaranty. 😊

***Tip:** Note that overclocking may also cause thermal problem. Please make sure that the cooling fan and the heatsink were adequate to dissipate excessive heat that's generated by overclocking the CPU.*

***Warning:** The design of this product follows CPU and chipset vendor's design guideline. Any attempts to push beyond product specification are not recommended and you are taking your own risk to damage your system or important data. Before doing overclocking, you must make sure your components are able to tolerate such abnormal setting, especially CPU, SDRAM, hard disks, and AGP VGA cards.*

VGA Card & Hard Disk

VGA and HDD is key components for overclocking, for your reference, the following list are what have been successful overclocked in our lab. Please note that AOpen can not guaranty they can be successful overclocked again. Please check the **Available Vendor List (AVL)** by link to our official website.

VGA: <http://english.aopen.com.tw/tech/report/overclk/mb/vga-oc.htm>

HDD: <http://english.aopen.com.tw/tech/report/overclk/mb/hdd-oc.htm>

Glossary

AC97

Basically, AC97 specification separates sound/modem circuit to two parts, digital processor and a [CODEC](#) for analog I/O they are linked by AC97 link bus. Since digital processor can be put into motherboard main chipset, the cost of sound/modem onboard solution can be reduced.

ACPI (Advanced Configuration & Power Interface)

ACPI is the power management specification of PC97 (1997). It intends to save more power by taking full control of power management to operating system and bypass [BIOS](#). The chipset or super I/O chip needs to provide standard register interface to operating system (such as Windows 98). This is a bit similar as the [PnP](#) register interface. ACPI defines ATX momentary soft power switch to control the power state transition.

AGP (Accelerated Graphic Port)

AGP is a bus interface targeted for high-performance 3D graphic. AGP supports only memory read/write operation and single-master single-slave one-to-one only. AGP uses both rising and falling edge of the 66MHz clock, for 2X AGP, the data transfer rate is $66\text{MHz} \times 4\text{byte} \times 2 = 528\text{MB/s}$. AGP is now moving to 4X mode, $66\text{MHz} \times 4\text{byte} \times 4 = 1056\text{MB/s}$. AOpen is the first company to support 4X AGP motherboards by both AX6C (Intel 820) and MX64/AX64 (VIA 694x), started from Oct 1999.

AMR (Audio/Modem Riser)

The [CODEC](#) circuit of AC97 sound/modem solution can be put on motherboard or put on a riser card (AMR card) that connects to motherboard through AMR connector.

AOpen Bonus Pack CD

A disc bundled with AOpen motherboard product, there are motherboard drivers, Acrobat Reader for [PDF](#) online manual and other useful utilities.

APM (Advanced Power Management)

Unlike [ACPI](#), BIOS controls most APM power management functions. AOpen Suspend to Hard Drive is a good example of APM power management.

ATA (AT Attachment)

ATA is the specification of diskette interface. In 80's, many software and hardware manufacturers instituted the ATA specification together. The AT is meaning International Business Machines Corporation (IBM) personal computer/AT's bus structure.

ATA/66

ATA/66 uses both rising edge and falling edge but doubles [UDMA/33](#) transfer rate. The data transfer rate is 4 times of the PIO mode 4 or DMA mode 2, 16.6MB/s x4 = 66MB/s. To use ATA/66, you need special ATA/66 IDE cable.

ATA/100

ATA/100 is a new IDE specification under developing. ATA/100 uses both rising edge and falling edge as [ATA/66](#) but clock cycle time is reduced to 40ns. The data transfer rate is $(1/40\text{ns}) \times 2 \text{ bytes} \times 2 = 100\text{MB/s}$. To use ATA/100, you need special 80-wire IDE cable, the same as ATA/66.

ATA/133

ATA/133 is a new IDE specification under developing. ATA/133 uses both rising edge and falling edge as [ATA/66](#) but clock cycle time is reduced to 30ns. The data transfer rate is $(1/30\text{ns}) \times 2 \text{ bytes} \times 2 = 133\text{MB/s}$. To use ATA/133, you need special 80-wire IDE cable, the same as ATA/66.

BIOS (Basic Input/Output System)

BIOS is a set of assembly routine/program that reside in [EPROM](#) or [Flash ROM](#). BIOS controls Input/output devices and other hardware devices of motherboard. In general, to provide hardware independent portability, operation system and drivers is required to access BIOS without directly access hardware devices.

Bus Master IDE (DMA mode)

The traditional PIO (Programmable I/O) IDE requires the CPU to involve in all the activities of the IDE access including waiting for the mechanical events. To reduce the workload of the CPU, the bus master IDE device transfers data from/to memory without interrupting CPU, and releases CPU to operate concurrently while data is transferring between memory and IDE device. You need the bus master IDE driver and the bus master IDE HDD to support bus master IDE mode.

CNR (Communication and Networking Riser)

The CNR specification provides the PC industry the opportunity to deliver a flexible and cost reduced method of implementing LAN, home networking, DSL, USB, wireless, audio and modem subsystems widely used in today's "connected PCs". The CNR specification is an open industry specification and is supported by OEMs, IHV card manufacturers, silicon supplier and Microsoft.

CODEC (Coding and Decoding)

Normally, CODEC means a circuit that can do digital to analog conversion and also the analog to digital conversion. It is part of [AC97](#) sound/modem solution.

DDR (Double Data Rate) SDRAM

DDR SDRAM utilizes the existing SDRAM infrastructure and technology while doubling the nominal bandwidth available to systems in an easy to design and simple to adopt way. Initially a perfect solution for memory intensive server and workstation applications, DDR low cost and low voltage will ultimately make it an ideal solution for all segments of the PC market, high performance desktop and mobile PCs, Value PCs and even Internet Appliances and mobile devices.

DIMM (Dual In Line Memory Module)

DIMM socket has total 168-pin and supports 64-bit data. It can be single or double side, the golden finger signals on each side of PCB are different, and that is why it was called Dual In Line. Almost all DIMMs are made by [SDRAM](#), which operate at 3.3V. Note that some old DIMMs are made by FPM/[EDO](#) and only operate at 5V. Do not confuse them with SDRAM DIMM which operates at 2.5V..

DMA (Direct Memory Access)

Channel for communications between the memory and surrounding devices.

ECC (Error Checking and Correction)

The ECC mode needs 8 ECC bits for 64-bit data. Each time memory is accessed; ECC bits are updated and checked by a special algorithm. The ECC algorithm has the ability to detect double-bit error and automatically correct single-bit error while parity mode can only detect single-bit error.

EDO (Extended Data Output) Memory

The EDO DRAM technology is actually very similar to FPM (Fast Page Mode). Unlike traditional FPM that tri-states the memory output data to start the pre-charge activity, EDO DRAM holds the memory data valid until the next memory access cycle, that is similar to pipeline effect and reduces one clock state.

EEPROM (Electronic Erasable Programmable ROM)

Also known as E²PROM. Both EEPROM and [Flash ROM](#) can be re-programmed by electronic signals, but the interface technology is different. Size of EEPROM is much smaller than flash ROM.

EPROM (Erasable Programmable ROM)

Traditional motherboard stores BIOS code in EPROM. EPROM can only be erased by ultra-violet (UV) light. If BIOS has to be upgraded, you need to remove EPROM from motherboard, clear by UV light, re-program, and then insert back.

EV6 Bus

EV6 Bus is the technology of Alpha processor from Digital Equipment Corporation. EV6 bus uses both rising and falling clock edge to transfer data, similar as DDR SDRAM or ATA/66 IDE bus.

EV6 Bus Speed = CPU external bus clock x 2.

For example, 200 MHz EV6 bus is actually using 100 MHz external bus clock, but the equivalent speed is 200 MHz.

FCC DoC (Declaration of Conformity)

The DoC is component certification standard of FCC EMI regulations. This standard allows DIY component (such as motherboard) to apply DoC label separately without a shielding of housing.

FC-PGA (Flip Chip-Pin Grid Array)

FC means Flip Chip, FC-PGA is a package of Intel for Pentium III CPU. It can plug into SKT370 socket.

Flash ROM

Flash ROM can be re-programmed by electronic signals. It is easier for BIOS to upgrade by a flash utility, but it is also easier to be infected by virus. Because of increase of new functions, BIOS size is increased from 64KB to 256KB (2M bit). AOpen AX5T is the first board to implement 256KB (2Mbit) Flash ROM. Now flash ROM size is moving to 4M bit on AX6C (Intel 820) and MX3W (Intel 810) motherboard. , AOpen motherboard uses EEPROM for jumper-less and battery-less design.

FSB (Front Side Bus) Clock

FSB Clock means CPU external bus clock.

CPU internal clock = CPU FSB Clock x CPU Clock Ratio

I²C Bus

See [SMBus](#).

IEEE 1394

IEEE 1394 is a low-cost digital interface originated by Apple Computer as a desktop LAN and developed by the IEEE 1394 working group. The IEEE 1394 can transport data at 100, 200 or 400 Mbps. One of the solutions to connect digital television devices together at 200 Mbps. Serial Bus Management provides overall configuration control of the serial bus in the form of optimizing arbitration timing, guarantee of adequate electrical power for all devices on the bus, assignment of isochronous channel ID, and notification of errors. There are two type of IEEE 1394 data transfer: asynchronous and isochronous. Asynchronous transport is the traditional computer memory-mapped, load and store interface. Data requests are sent to a specific address and an acknowledgment is returned. In addition to an architecture that scales with silicon technology, IEEE 1394 features a unique isochronous data channel interface. Isochronous data channels provide guaranteed data transport at a pre-determined rate. This is especially important for time-critical multimedia data where just-in-time delivery eliminates the need for costly buffering.

Parity Bit

The parity mode uses 1 parity bit for each byte, normally it is even parity mode, that is, each time the memory data is updated, parity bit will be adjusted to have even count "1" for each byte. When next time, if memory is read with odd number of "1", the parity error is occurred and this is called single bit error detection.

PBSRAM (Pipelined Burst SRAM)

For Socket 7 CPU, one burst data read requires four QWord (Quad-word, $4 \times 16 = 64$ bits). PBSRAM only needs one address decoding time and automatically sends the remaining QWords to CPU according to a predefined sequence. Normally, it is 3-1-1-1, total 6 clocks, which is faster than asynchronous SRAM. PBSRAM is often used on L2 (level 2) cache of Socket 7 CPU. Slot 1 and Socket 370 CPU do not need PBSRAM.

PC-100 DIMM

[SDRAM](#) DIMM that supports 100MHz CPU [FSB](#) bus clock.

PC-133 DIMM

[SDRAM](#) DIMM that supports 133MHz CPU [FSB](#) bus clock.

PC-1600 / PC-2100/ PC-2700 / PC-3200 DDR DRAM

Based on FSB frequency, the DDR DRAM has 200MHz, 266MHz and 333 MHz three types of working frequency. Because of DDR DRAM data bus is 64-bit, it provides data transfer bandwidth up to $200 \times 64 / 8 = 1600 \text{MB/s}$, $266 \times 64 / 8 = 2100 \text{MB/s}$, $333 \times 64 / 8 = 2700 \text{MB/s}$ and $400 \times 64 / 8 = 3200 \text{MB/s}$. Hence, the PC-1600 DDR DRAM is working with 100MHz, PC-2100 DDR DRAM is working with 133MHz, PC-2700 DDR DRAM is working with 166MHz and PC-3200 DDR DRAM is working with 200MHz FSB frequency.

PCI (Peripheral Component Interface) Bus

Bus for the internal connection of peripheral devices, high-speed data channel between the computer and expansion card.

PDF Format

A file format for electronic document, PDF format is independent from platform, you can read PDF file under Windows, Unix, Linux, Mac ... with different PDF reader. You can also read PDF file by web browser such as IE and Netscape, note that you need to install PDF plug-in first (Included in Acrobat Reader).

PnP (Plug and Play)

The PnP specification suggests a standard register interface for both BIOS and operating system (such as Windows 95). These registers are used by BIOS and operating system to configure system resource and prevent any conflicts. PnP BIOS or operating system will automatically allocate the IRQ/DMA/Memory. Currently, almost all the PCI cards and most ISA cards are already PnP compliant.

POST (Power-On Self Test)

The BIOS self-test procedure after power-on, sometimes, it is the first or the second screen shown on your monitor during system boot.

RDRAM (Rambus DRAM)

Rambus is a memory technology that uses large burst mode data transfer. Theoretically, the data transfer should be high than [SDRAM](#). RDRAM is cascaded in channel operation. For Intel 820, only one RDRAM channel is supported, 16-bit data per channel, and this channel may have maximum 32 RDRAM devices, no matter how many [RIMM](#) sockets.

RIMM (Rambus Inline Memory Module)

184-pin memory module that supports [RDRAM](#) memory technology. A RIMM memory module may contain up to maximum of 16 RDRAM devices.

SDRAM (Synchronous DRAM)

SDRAM is one of the DRAM technologies that allow DRAM to use the same clock as the CPU host bus ([EDO](#) and FPM are asynchronous and do not have clock signal). It is similar as [PBSRAM](#) to use burst mode transfer. SDRAM comes in 64-bit 168-pin [DIMM](#) and operates at 3.3V. AOpen is the first company to support dual-SDRAM DIMMs onboard (AP5V), from Q1 1996

Shadow E²PROM

A memory space in Flash-ROM to simulate E²PROM operation, AOpen motherboard uses Shadow E²PROM for jumper-less and battery-less design

SIMM (Single In Line Memory Module)

SIMM socket is only 72-pin, and is only single side. The golden finger signals on each side of PCB are identical. That is why it was called Single In Line. SIMM is made by FPM or [EDO](#) DRAM and supports 32-bit data. SIMM had been phased out on current motherboard design.

SMBus (System Management Bus)

SMBus is also called I2C bus. It is a two-wire bus developed for component communication (especially for semiconductor IC). For example, set clock of clock generator for jumper-less motherboard. The data transfer rate of SMBus is only 100Kbit/s, it allows one host to communicate with CPU and many masters and slaves to send/receive message.

SPD (Serial Presence Detect)

SPD is a small ROM or [EEPROM](#) device resided on the [DIMM](#) or [RIMM](#). SPD stores memory module information such as DRAM timing and chip parameters. SPD can be used by [BIOS](#) to decide best timing for this DIMM or RIMM.

Ultra DMA

Ultra DMA (or, more accurately, Ultra DMA/33) is a protocol for transferring data between a hard disk drive through the computer's data path (or bus) to the computer's random access memory (RAM). The Ultra DMA/33 protocol transfers data in burst mode at a rate of 33.3MB/s, twice as fast as the previous [Direct Access Memory \(DMA\)](#) interface. Ultra DMA was developed as a proposed industry standard by the Quantum corporation, makes of hard disk drives, and Intel, makes of chipset that support computer bus technology. Ultra DMA support in your computer means that it will boot (start) and open new applications more quickly. It will help users of graphic-intensive and applications that require large amounts of access to data on the hard disk drive. Ultra DMA uses Cyclical Redundancy Checking (CRC), offering a new level of data protection. Ultra DMA uses the same 40-pin IDE interface cable as PIO and DMA.

16.6MB/s x2 = 33MB/s

16.6MB/s x4 = 66MB/s

16.6MB/s x6 = 100MB/s

USB (Universal Serial Bus)

Compared to traditional USB 1.0/1.1 with the speed of 12Mbps, USB 2.0 has a fancy speed up to 480 Mbps that is 40 times faster than the traditional one. Except for the speed increase, USB 2.0 supports old USB 1.0/1.1 software and peripherals, offering impressive and even better compatibility to customers.

VCM (Virtual Channel Memory)

NEC's Virtual Channel Memory (VCM) is a new DRAM core architecture that dramatically improves the memory system's ability to service multimedia requirements. VCM increases memory bus efficiency and performance of any DRAM technology by providing a set of fast static registers between the memory core and I/O pins. Using VCM technology results in reduced data access latency and reduced power consumption.

ZIP file

A compressed file format to reduce file size. To unzip file, run shareware PKUNZIP (<http://www.pkware.com/>) for DOS and other operating system or WINZIP (<http://www.winzip.com/>) for windows environment.



Troubleshooting

If you encounter any trouble to boot your system, follow the procedures accordingly to resolve the problem.

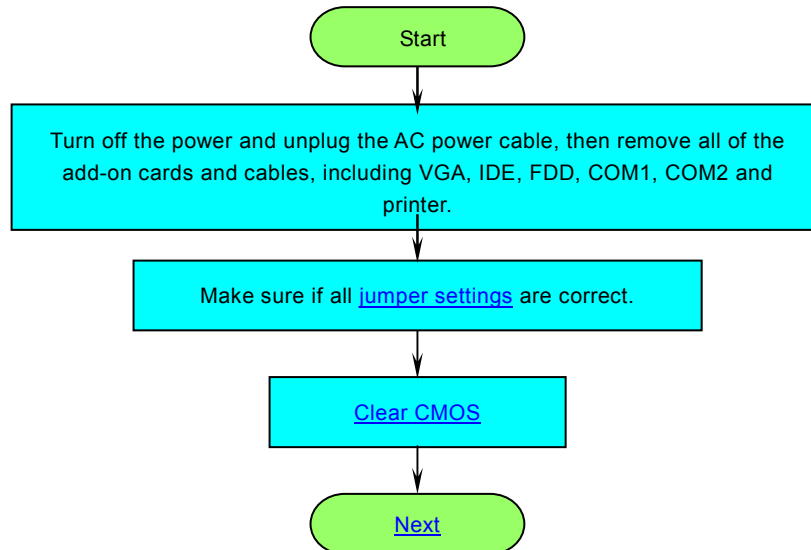

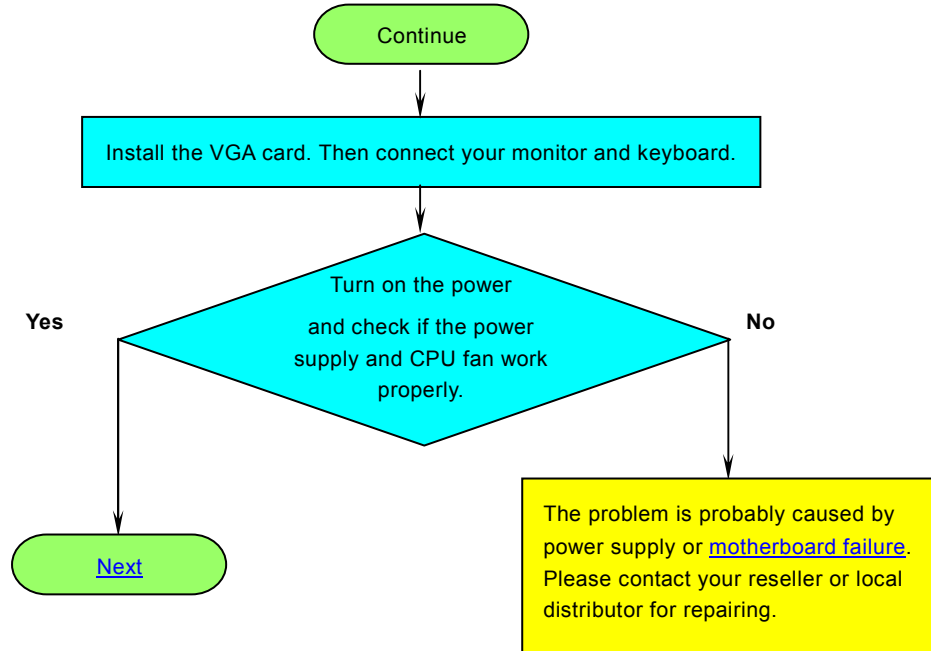

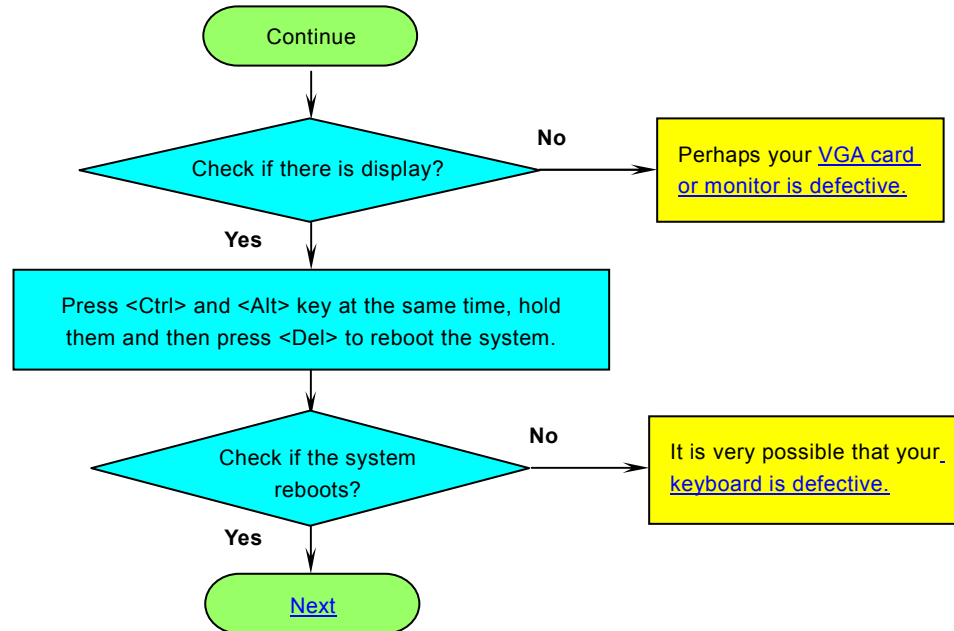

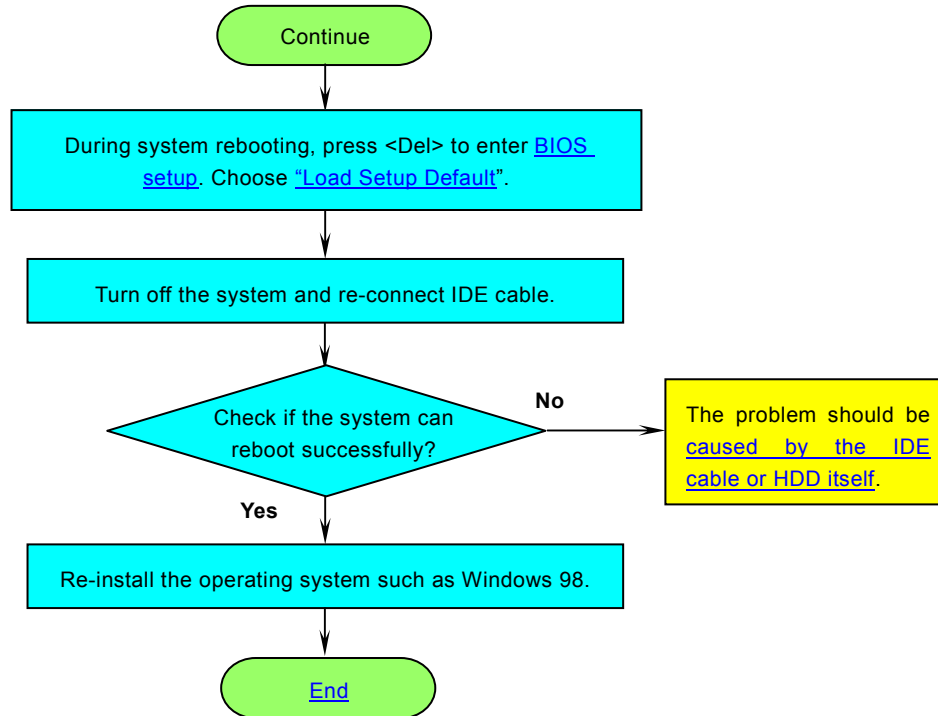



Technical Support

Dear Customer,

Thanks for choosing AOpen products. To provide the best and fastest service to our customer is our first priority. However, we receive numerous emails and phone-calls worldwide everyday, it is very hard for us to serve everyone on time. We recommend you follow the procedures below and seek help before contact us. With your help, we can then continue to provide the best quality service to more customers.

Thanks very much for your understanding!

AOpen Technical Supporting Team

1

Online Manual: Please check the manual carefully and make sure the jumper settings and installation procedure are correct.

<http://english.aopen.com.tw/tech/download/manual/default.htm>

2

Test Report: We recommend choosing board/card/device from the compatibility test reports for assembling your PC.

<http://english.aopen.com.tw/tech/report/default.htm>

3

FAQ: The latest FAQ (Frequently Asked Questions) may contain a solution to your problem.

<http://english.aopen.com.tw/tech/faq/default.htm>

4

Download Software: Check out this table to get the latest updated BIOS/utility and drivers.

<http://english.aopen.com.tw/tech/download/default.htm>

5

News Group: News posted by computer experts, you are welcome to join any discussion and learning from it.
<http://english.aopen.com.tw/tech/newsgrp/default.htm>

6

Contact Distributors/Resellers: We sell our products through resellers and integrators. They should know your system configuration very well and should be able to solve your problem more efficiently than us. After all, their attitude of service is an important reference for you if next time you want to buy something else from them.

7

Contact Us: Please prepare detail system configuration and error symptom before contacting us. The **part number**, **serial number** and **BIOS version** are also very helpful.

Part Number and Serial Number

The Part Number and Serial number are printed on bar code label. You can find this bar code label on the outside packing, or on component side of PCB. For example:



Part No.

Serial No.



Part No.

Serial No.

P/N: 91.88110.201 is part number, **S/N: 91949378KN73** is serial number.

Model name and BIOS version

Model name and BIOS version can be found on upper left corner of first boot screen ([POST](#) screen). For example:

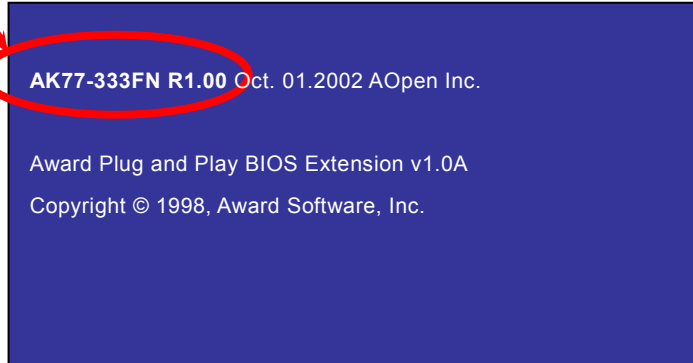

AK77-333FN is model name of motherboard, **R1.02** is BIOS version.



Product Registration

ClubAOpen

Welcome to AOpen Inc.



Thank you for choosing AOpen product. AOpen encourages you to spend few minutes in completing the following product registration. To register your product will ensure the high quality of services from AOpen. After the registration, you will:

- Have opportunities to play online slot machine and win a prize from AOpen by accumulating your bonuses for later prize exchange.
- Be upgraded to gold membership of Club AOpen program.
- Receive email notification about product safety alerts. Its purpose is to alert consumers quickly and conveniently when products contain technical issues.
- Receive email notification about latest product's announcements.
- Be able to personalize your AOpen web pages.
- Receive e-mail notification about latest BIOS/Driver/Software release information.
- Have opportunities to participate special product promotional programs.
- Enjoy higher service priority to receive technical assistance provided by AOpen specialists worldwide.
- Be able to join the discussions of web-based news groups.

AOpen makes sure that the information you provide is encrypted, so that it cannot be read or intercepted by other people or companies. Further, AOpen will not disclose any of information you submitted under any conditions. Please consult our [online privacy policy](#) for further information on our company policy.

Note: *If registering products purchased from different dealers/retails and/or purchased on different dates, please submit a separate form for each product.*

AOpen



How to Contact Us



Please do not hesitate contact us if you have any problem about our products. Any opinion will be appreciated.

Pacific Rim
AOpen Inc.
Tel: 886-2-3789-5888
Fax: 886-2-3789-5899

Europe
AOpen Computer b.v.
Tel: 31-73-645-9516
Fax: 31-73-645-9604

America
AOpen America Inc.
Tel: 1-510-489-8928
Fax: 1-510-489-1998

China
艾爾鵬國際貿易(上海)有限公司
Tel: 86-21-6225-8622
Fax: 86-21-6225-7926

Germany
AOpen Computer GmbH.
Tel: 49-1805-559191
Fax: 49-2102-157799

Japan
AOpen Japan Inc.
Tel: 81-048-290-1800
Fax: 81-048-290-1820

Web Site: www.aopen.com

E-mail: Send us email by going through the contact form below.

English <http://english.aopen.com.tw/tech/default.htm>

Japanese <http://www.aopen.co.jp/tech/default.htm>

Chinese <http://www.aopen.com.tw/tech/default.htm>

German <http://www.aopencom.de/tech/default.htm>

Simplified Chinese <http://www.aopen.com.cn/tech/default.htm>

