

# LAVAMAT 62800

Washing Machine

User information



## Dear Customer,

Please read this user information carefully and keep it to refer to later. Please pass the user information on to any future owner of the appliance.

### The following symbols are used in the text:



Safety instructions

**Warning!** Information that affects your personal safety.

**Important!** Information that prevents damage to the appliance.



Useful tips and hints



Environmental information

# Contents

<b>Operating Instructions</b> .....	5
<b>Safety</b> .....	5
<b>Disposal</b> .....	6
<b>Description of the appliance</b> .....	7
<b>Control panel</b> .....	7
<b>Programme overview</b> .....	8
<b>Before the first wash</b> .....	10
<b>Preparing and sorting washing</b> .....	10
<b>Running a wash cycle</b> .....	11
Opening the door/loading washing .....	11
Adding detergent /conditioner .....	11
Switching on the appliance/selecting a programme .....	12
Changing the spin speed/selecting rinse hold .....	13
Selecting additional programmes .....	13
RINSE + .....	13
TIME SAVER.....	13
PRE WASH.....	14
STAIN .....	14
Starting a programme.....	14
Programme sequence .....	14
Interrupting a programme/adding washing .....	14
End of the wash cycle/removing the washing .....	15
<b>Child safety device</b> .....	16
<b>Cleaning and care</b> .....	17
<b>What to do if</b> .....	18
Remedying small faults yourself .....	18
If the wash result is not satisfactory .....	20
Carrying out an emergency drain .....	21
Drain pump.....	22
<b>Technical data</b> .....	23
<b>Consumption values</b> .....	23

---

<b>Installation and connection instructions</b> .....	24
<b>Safety information concerning installation</b> .....	24
<b>Installing the appliance</b> .....	25
Transporting the appliance.....	25
Removing the transit packaging .....	25
Where to install .....	26
Making the appliance level.....	27
<b>Electrical Connection</b> .....	27
<b>Connecting the appliance to the water supply</b> .....	29
Water inlet .....	30
Water Drainage .....	31
<b>Warranty conditions</b> .....	33
<b>Service and Spare Parts</b> .....	35

---

# Operating Instructions

## Safety

### **Prior to using the appliance for the first time**

- Follow the **"Installation and connection instructions"**.
- If the appliance is delivered in the winter months when there are minus temperatures: store the washing machine at room temperature for 24 hours before using for the first time.

### **Correct use**

- The washing machine is only designed for the washing of normal domestic laundry at home.
- Additions or modifications to the washing machine are not permitted.
- Only use detergents/conditioners that are suitable for use in domestic washing machines.
- The washing must not contain any flammable solvent. The risk of explosion exists.
- Do not use the washing machine for dry cleaning.
- Dyes/colour removers may only be used in the washing machine, if the manufacturer of these products expressly permits this. We cannot accept liability for any damage arising.

### **Child safety**

- Keep packaging away from children. There is a risk of suffocation.
- Children often do not recognise the hazards associated with electrical appliances. Don't allow children to use the washing machine unsupervised.
- Make sure that children and pets don't climb into the drum of the washing machine. The risk of death exists.

### **General safety**

- Repairs to the washing machine may only be carried out by qualified/authorised service engineers.
- Never use the appliance when the electrical cable is damaged or the control panel, worktop or plinth area are damaged to such an extent that the inside of the appliance is openly accessible.

- Switch off the washing machine prior to cleaning it and carrying out maintenance. In addition, remove the power plug from the power point or – if the appliance has been hard-wired – switch off the cut-out in the fuse box or completely remove the fuse.
- If operation is stopped, disconnect the appliance from the mains supply and turn off the tap.
- Never remove the power plug from the power point by pulling on the cable. Always pull the plug.
- Multiway-plugs, connectors and extension cables must not be used. **Resulting overheating may constitute a fire hazard.**
- Never wash the washing machine down with a water jet. Danger of electric shock.
- When using wash programmes with high temperatures the glass in the door will become hot. Do not touch it!
- Before emergency emptying of the appliance, before cleaning the drain pump or opening the door in an emergency, let the water cool down.
- Small animals can nibble on electrical cables and water hoses. This can constitute a risk of electrocution and water damage. Keep small animals away from the washing machine.

## Disposal



### Packaging material

The packaging materials are environmentally friendly and can be recycled. The plastic components are identified by markings, e.g. >PE<, >PS<, etc. Please dispose of the packaging materials in the appropriate container at your local waste disposal facilities.



### Old appliance

Please dispose of your old appliance in line with the guidelines for disposal in your area.



**Warning:** When your appliance has finished its working life, remove the plug from the mains socket. Cut off the cable and plug and dispose of them.

Destroy the door lock. This prevents children from trapping themselves inside and endangering their lives.



# Programme overview









Programme	max. load <sup>1)</sup> (dry washing)	Additional programmes				Spin speed		RINSE HOLD
		RINSE +	TIME SAVER	PRE WASH	STAIN	1200	700	
ENERGY SAVING <sup>2)</sup>	6kg	•		•	•	•	•	•
COTTONS/LINEN 95, 60, 50, 40, 30	6kg	•	•	•	• <sup>3)</sup>	•	•	•
EASY-CARES 60, 50, 40, 30, 20	3kg	•	•	•	• <sup>3)</sup>		•	•
DELICATES 40, 30	3kg	•	•	•			•	•
WOOL/  (Hand-washing) 40, 30, COLD	2kg						•	•
RINSE	3kg						•	•
DRAIN	-							
SPIN	6kg					•	•	
REFRESH	3kg						•	•

1) A 10 litre bucket contains approx. 2.5 kg dry washing (cotton)

2) Programme settings for tests in accordance with or in the style of EN 60 456 and IEC 60 456 are described in the chapter "Consumption values".

3) STAIN can only be set from 40°C upwards, as stain removal agent only becomes effective at higher temperatures.



Application/Features	Care symbols <sup>1)</sup>
Energy-saving programme which washes at 60 °C for lightly to normally soiled whites or coloureds made of cotton/linen.	
Programme for normally to heavily soiled whites/coloureds made of cotton/linen.	
Programme for easy-care mixed fibres and synthetics.	
Gentle programme for delicate textiles such as bonded fibres, micro-fibres, synthetics, net curtains (load max. 20 to 25 m <sup>2</sup> curtains). If used together with RINSE HOLD, also suitable for fabrics with climatic membranes, e.g. outdoor. clothing.	
Specially gentle programme for machine and hand-washable wool/silk.	
Separate gentle rinse (3 rinse cycles, liquid conditioner is washed in from the compartment  , gentle spin).	
Draining following a rinse hold.	
Draining and spinning, e.g. following a rinse hold, or separate spinning of hand-washed cottons/linen.	
Special programme which washes at 30 °C, approx. 30 minutes, for brief washing of e.g. worn-once, lightly soiled sports clothing or new clothes.	

1) The figures in the care symbols indicate the maximum temperatures.

## Before the first wash

1. Open the detergent drawer.
2. Pour approx. 1 litre of water through the detergent drawer into the washing machine.  
This closes the water container when the next programme is started and the economy valve can function properly
3. To remove any production-related residues from the drum and water tank, perform the first wash cycle without a load. Programme: COTTONS/LINEN 60, press the TIME SAVER button, add approx. 1/4 measuring cup of detergent.

## Preparing and sorting washing

### Preparing washing

- Empty the pockets. Remove foreign bodies (e.g. coins, paper clips, nails, etc.).
- Do up zips, button up covers to prevent damage to washing.
- Remove the runners from net curtains or cover them with a net or a bag.
- Wash delicate and small items in a net/pillowcase, e. g. net curtains, tights, small socks, handkerchiefs, bras.

**Important:** Bras and other items containing wires should only be washed in a net bag. The wires can work loose and damage the appliance.

### Sorting washing

- By colour: Wash white and coloured washing separately. Washing can run.
- By temperature, type of washing and care symbol.

**Important:** Do not wash fabrics with the  care symbol (= do not wash!) in the washing machine.

# Running a wash cycle

## Opening the door/loading washing

1. Open the door: pull the handle on the door.

When the appliance is switched on, the DOOR and START/PAUSE indicators show whether the door can be opened:

DOOR indicator	START/PAUSE indicator	Can the door be opened?
illuminated green	flashing red or not illuminated	yes
illuminated green	illuminated red	yes, after pressing the START/PAUSE button

During the programme the door is locked when the water level or the temperature is high. The DOOR indicator is not illuminated.

2. Separate washing and load it loosely.

Mix large and small items.

**Important:** Do not get any washing caught between the door and the rubber seal.

3. Firmly push the door shut. Door catch must audibly click shut.

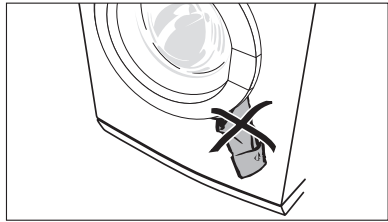

## Adding detergent /conditioner

**Important:** Only use detergents/conditioners that are suitable for use in household washing machines.

Add detergent/conditioner in accordance with the detergent/conditioner manufacturer's instructions. Observe instructions on the packaging.

The amount of detergent used depends on:

- the degree of soiling,
- the load size
- the hardness of the tap water.

- If the manufacturer does not make any recommendations with regard to small volumes of washing: For a half-load use a third less, and for a very small load use only the half the amount of detergent that is recommended for a full load.
- Water softener should be used from water hardness range 2 (=medium). The amount of detergent used can then always be that as for hardness range 1 (=soft). Your local water company will provide you with information about water hardness in your area.

1. Pull out the detergent drawer as far as it will go.
2. Add the detergent/conditioner.
3. Push the detergent drawer in fully.

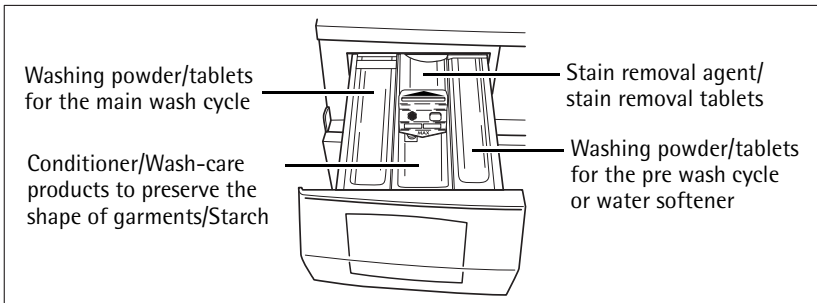

### Washing powder/tablets for the main wash cycle

If you are using water softener and require the right compartment for detergent for the pre-wash cycle, add the water softener on top of the detergent for the main wash cycle in the left compartment.

### Softener, wash-care products to preserve the shape of garments, starch

Fill the compartment to no more than the MAX indicator. Add water to thick liquid concentrates in accordance with the manufacturer's instructions before using them. Dissolve powder starch.

### If you are using liquid detergent:

Add liquid detergent using measuring containers provided by the detergent manufacturer.

## Switching on the appliance/selecting a programme

Set the programme and temperature using the programme selector.



The appliance is switched on by selecting a programme.

- The programme progress display shows the programme steps that the selected programme will carry out.
- The estimated programme duration (in minutes) appears in the multi-display.

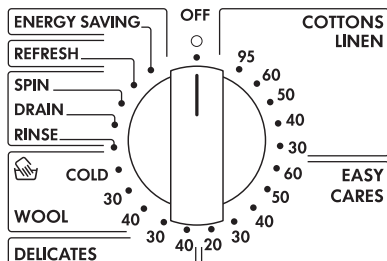

## Changing the spin speed/selecting rinse hold

The washing machine suggests the maximum permitted spin speed suitable for the selected programme. You can reduce this spin speed:

To do this, press the Spin/RINSE HOLD button repeatedly until the required indicator is illuminated.

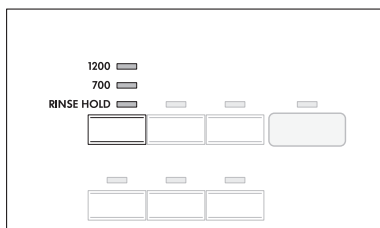

**i** The spin speed for the final spin can be changed even during the programme. To do this:

1. Press the START/PAUSE button.
2. Change the spin speed.
3. Press the START/PAUSE button again.

### RINSE HOLD

With RINSE HOLD the washing is left to soak in the final rinse water. No final spin takes place, only the intermediate spin. The intermediate spin depends on the programme and cannot be changed.

## Selecting additional programmes

If required, press additional programme button(s). The corresponding indicator will illuminate.

**i** If "Err" flashes in the multi-display, the selected additional programme cannot be used together with the wash programme set.

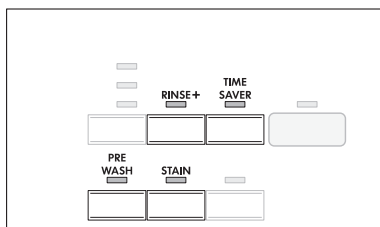

### RINSE +

Two additional rinse cycles are carried out for the programmes ENERGY SAVING, COTTONS/LINEN, EASY-CARES and DELICATES (for example in cases of over-sensitive skin).

### TIME SAVER

Shortened wash programme for lightly soiled items.

## PRE WASH

Warm pre-wash before the main wash that follows automatically; with intermediate spin for COTTONS/LINEN and EASY-CARES, without intermediate spin for DELICATES.

## STAIN

For heavily soiled or stained washing. Stain removal agent will be rinsed into the wash at the optimum point in the programme.

Can only be set for wash temperatures of 40°C and upwards as stain removers only become effective at higher temperatures.

## Starting a programme

1. Check that the tap is turned on.
2. Press the START/PAUSE button. The programme is started.



If after pressing the START/PAUSE button **E40** flashes in the multi-display, the END indicator flashes 4 times and at the same time an acoustic signal sounds 4 times, the door has not been correctly shut. Push the door firmly closed and press the START/PAUSE button again.

## Programme sequence

- The programme progress display shows the programme step that is currently being carried out.
- The multi-display shows the estimated time remaining (in minutes) until the end of the programme.



The time remaining can increase or stay the same for a while during the course of the cycle as the programme adjusts itself to various conditions (e.g. type of washing and quantity, out of balance spin detection, special rinse cycle, etc.).

## Interrupting a programme/adding washing

### Interrupting a programme

- A programme can at any time be interrupted by pressing the START/PAUSE button and resumed by pressing START/PAUSE again.
- To cancel a programme before it has ended, turn the programme selector to OFF. **Important:** Be careful of water in the appliance.

### **Adding washing**

Washing can be added, as long as the DOOR indicator is illuminated green.

1. Press the START/PAUSE button. The door can be opened.
2. Close the door and press the START/PAUSE button again. The programme will continue.

## **End of the wash cycle/removing the washing**

At the end of the programme, END lights up on the programme progress display. The door can be opened as soon as the DOOR indicator is lit green.

1. Open the loading door and remove the washing.
2. Turn the programme knob to OFF.
3. Close the water valve.
4. After washing, pull out the detergent drawer a little to enable it to dry out. Keep the loading door very slightly open so that the washing machine can air.

### **If RINSE HOLD has been selected:**

After the rinse hold, END lights up on the programme progress display. The water must first be drained:

- Either turn the programme knob to OFF, then to DRAIN and press the START/PAUSE button (the water is drained without spinning),
- or turn the programme knob to OFF and then to SPIN. Change the spin speed if necessary and press the START/PAUSE button (the water is drained and the washing spun).

# Child safety device

If the child safety device has been activated, the door can no longer be shut.

## Activating the child safety device:

Use a coin to turn the knob (on the inside of the door) in a clockwise direction as far as it will go.

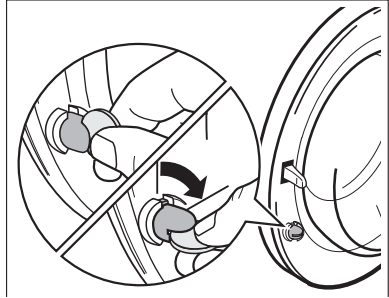

**Warning!** The knob must not be depressed after being set, otherwise the child safety device is not activated. The knob must stand proud as shown in the illustration.

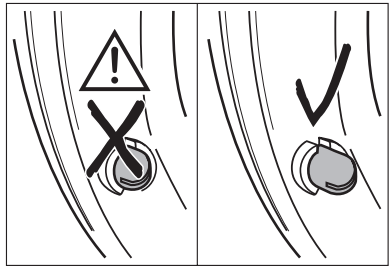

## Deactivating the child safety device:

Turn the knob in an anti-clockwise direction as far as it will go.



# Cleaning and care

**Important:** Do not use furniture cleaning products or aggressive cleaning agents to clean the appliance.

Wipe over the control panel and housing with a damp cloth.

## Detergent drawer

The detergent drawer should be cleaned regularly.

1. Remove the detergent drawer by pulling firmly.
2. Remove the softener insert from the middle compartment.
3. Clean all parts with water.
4. Place the softener insert in as far as it will go, so that it is firmly in position.

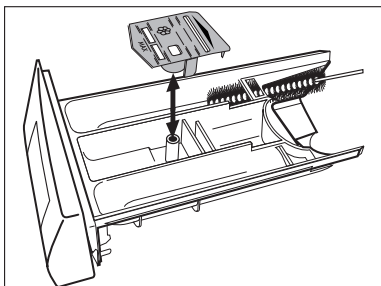

5. Clean the entire drawer recess area of the washing machine, in particular the jets on the upper side of the washing-in chamber, with a brush.
6. Place the detergent drawer in its guide rails and push it in.

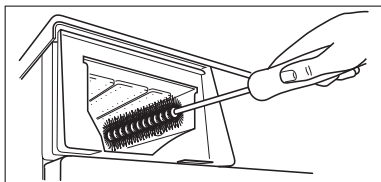

## Washing drum

Rust deposits in the drum may occur due to rusting foreign bodies in the washing or tap water containing iron.

**Important!** Do not clean the drum with acidic descaling agents, scouring agents containing chlorine or iron or steel wool.

1. Remove any rust which has accumulated in the drum using a cleaning agent for stainless steel.
2. Run a washing cycle without any washing to clean off any cleaning agent residues. Programme: COTTONS/LINEN 60, press the TIME SAVER button, add approx. 1/4 measuring cup of detergent.

## Door and rubber collar

Regularly check whether deposits or foreign substances are present in the folds of the rubber collar or inside on the door glass.

Regularly clean the door glass and the rubber collar.

# What to do if...

## Remedying small faults yourself

If during use of the appliance one of the following error codes is shown in the multi-display:

- **E 10** (Problems with the water inflow),
- **E20** (Problems with the water outflow),
- **E40** (door open),

please consult the following table.

After the error has been remedied, press the START/PAUSE button.

In the event of other errors (**E** and a number or letter): Switch the appliance off and then on again. Set the programme again. Press the START/PAUSE button.

If the error appears again, please contact your local Service Force Centre, stating the error code.

Problem	Possible cause	Remedy
Washing machine does not work.	Power plug not plugged in or problem with the fuse.	Connect the plug to a mains socket. Check the fuse.
	The door is not shut properly.	Close the door until the lock audibly clicks into place.
	The START/PAUSE button was not pressed for long enough.	Press the START/PAUSE button for a longer period of time.
The door cannot be closed.	The child safety device is activated.	Deactivate the child safety device:
When you press a button <b>Err</b> appears in the multi-display.	The selected function cannot be used together with the wash programme set.	Select another function.
<b>E40</b> appears. The END indicator is flashing 4 times, and simultaneously an acoustic signal is sounding 4 times.	The door is not closed properly.	Close the door properly. Restart the programme.

Problem	Possible cause	Remedy
<b>E 10</b> appears. The END indicator is flashing once, and simultaneously an acoustic signal is sounding once. (Problems with the water inflow.)	The tap is shut off.	Turn on the tap.
	The filter in the inlet hose screw connection is blocked.	Turn off the tap. Unscrew the hose, remove the filter and clean it.
	The tap is blocked by limescale or faulty.	Check the tap and have it repaired, if necessary.
The washing machine vibrates when operating or is not stable.	The transit packaging has not been removed.	Remove the transit packaging.
	The screw feet have not been correctly adjusted.	Adjust the feet as described in the installation and connection instructions.
	There is very little washing in the drum (e.g. just one bathrobe).	Operation is not affected by this.
Water is running out from under the washing machine.	The inlet hose screw connection is leaking.	Tighten the inlet hose.
	The outlet hose is leaking.	Replace outlet hose.
	The drain pump lid has not been closed properly.	Close the cover properly.
	Washing was caught in the door.	Load carefully next time you wash.
	The emergency drain hose is leaking.	Screw on the emergency drain hose firmly.
The wash water is foaming a lot. At the end of the wash cycle the spinning stops.	Probably too much detergent has been used.	Follow the manufacturer's instructions exactly when measuring out detergent.
<b>E20</b> appears. The END indicator is flashing twice, and simultaneously an acoustic signal is sounding twice. (Problems with the water outflow.)	There is a kink in the outlet hose.	Straighten the hose.
	The maximum pump height of 1 m has been exceeded.	Please contact your local Service Force Centre
	The drain pipe is blocked.	Switch off the appliance. Disconnect the power plug. Clean the drain pump. Remove foreign bodies from the pump housing.
	For sink spigot connections: The spigot is blocked.	Clean the spigot.

Problem	Possible cause	Remedy
Conditioner has not been rinsed in, compartment  for conditioner is filled with water.	The softener insert in the compartment for conditioners has not been correctly inserted or is blocked.	Clean the detergent drawer, insert the conditioner insert firmly.
The door cannot be opened when the washing machine is switched on.	The door is locked.	Wait until the DOOR indicator is illuminated green.
	There has been a power cut. (All the indicators have gone out.) The door remains locked for approx. 4 to 10 minutes.	The programme will continue when the power cut has ended.  To remove the washing: If water can be seen in the appliance, prior to opening the door first let the water out (see section "Carrying out an emergency drain").
The washing is badly creased.	Perhaps too many items were loaded.	Observe the maximum load volume.

## If the wash result is not satisfactory

### The washing is grey and there are limescale deposits in the drum

- Too little detergent was used.
- An incorrect detergent was used.
- Individual stains were not pre-treated.
- The programme or temperature was not set properly.

### There are grey stains on the washing

- Items that were soiled with ointments, fats or oils were washed using too little detergent.
- The wash temperature used was too low.
- A common cause is that conditioner – in particular the type in concentrated form – has come in contact with the washing. Wash out such marks as soon as possible and exercise care when using the said conditioner.

### Foam can still be seen following the final rinse

- Modern detergents can cause foam to be created even during the final rinse. In spite of this, the washing has been sufficiently rinsed.

## There are white residues on the washing

- What can be seen here are insoluble substances which modern detergents contain. They are not the result of insufficient rinsing. Shake or brush the washing. If possible turn the washing inside out before washing. Check your selection of detergent and perhaps use liquid detergent instead.

## Carrying out an emergency drain



**Warning!** Prior to carrying out an emergency drain, switch off the washing machine and remove the power plug from the power point.

**Warning!** The water that comes out of the emergency drain hose may be hot. There is a risk of scalding. Let the water cool before performing an emergency drain!

1. Open the plinth flap and remove it.

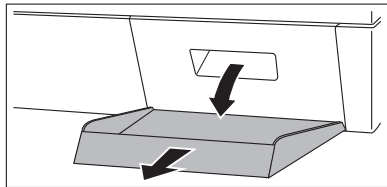

2. Remove the emergency drain hose.

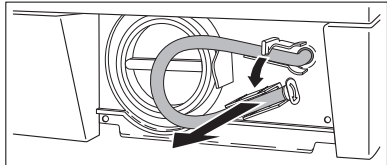

3. Place a shallow container underneath it. Then loosen the drain plug by turning it in an anti-clockwise direction and pull it out.

4. The water will run out. If it is necessary to empty the container more than once, seal up the emergency drain hose with the drain plug while you are doing so.

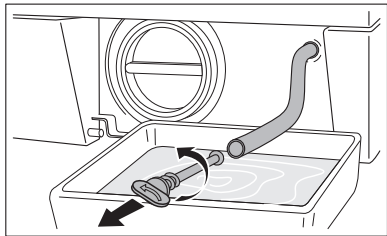

### When the water has all drained away:

5. Insert the plug firmly into the emergency drain hose and turn it in a clockwise direction until it is firmly in place.
6. Replace the emergency drain hose into the retainer.
7. Insert the plinth flap into place and close it.

## Drain pump

The drain pump is maintenance-free. It is only necessary to open the pump cover if there is a malfunction and water is no longer being pumped out, e.g. if the pump wheel is blocked.

Before loading the machine, please always ensure that there are no foreign bodies present in the pockets or in between the items to be washed. Paper clips, nails, etc. which may find their way into the washing machine along with the washing will remain in the drain pump housing (foreign body trap that protects the pump wheel).



**Warning!** Before opening the cover of the drain pump, switch off the washing machine and remove the power plug from the power point.

1. First carry out an emergency drain.
2. Place a cloth on the floor in front of the cover of the drain pump. Residual water runs out.
3. Unscrew the pump cover in an anti-clockwise direction and remove it.

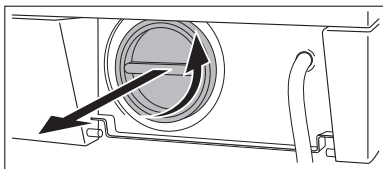

4. Remove foreign bodies and fluff from the pump housing and from the pump wheel.

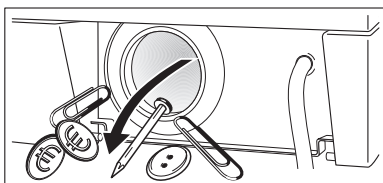

5. Check whether the pump wheel right at the back of the pump housing can turn. (If the wheel rotates with a jerky motion, this is normal.) If the pumping wheel cannot be turned, please contact your local Service Force Centre..

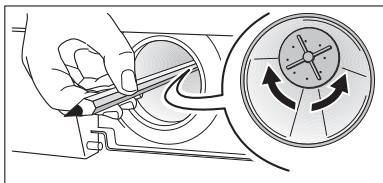

6. Insert the pump cover. Insert the guides at the sides of the cover into the guide slots and tighten the cover by turning in a clockwise direction.

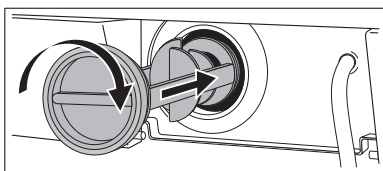

7. Close off the emergency drain hose and place it in the retainer.
8. Close the plinth flap.

## Technical data

- CE** This appliance conforms with the following EU Directives:
- 73/23/EEC dated 19.02.1973 Low Voltage Directive
  - 89/336/EEC dated 03.05.1989 EMC Directive inclusive of Amending Directive 92/31/EEC
  - 93/68/EEC dated 22.07.1993 CE Marking Directive

Height x width x depth	850 x 598 x 640mm
Depth when door is open	1,017 mm
Height adjustability	approx. +10/-5mm
Load (depending on programme)	max. 6kg
Area of use	Household
Drum spin speed	see Rating Plate
Water pressure	1-10 bar (=10-100N/cm <sup>2</sup> =0,1-1,0MPa)

## Consumption values

The consumption values were obtained under standardised conditions. They can differ in household use.

Programme selector (Temperature)	Load size in kg <sup>1)</sup>	Water in litres	Energy in kWh
ENERGY SAVING <sup>2)</sup>	6	49	1,02
COTTONS/LINEN 95	6	62	2,20
COTTONS/LINEN 40	6	58	0,70
EASY-CARES 40	3	58	0,52
DELICATES 30	3	58	0,42
WOOL  (Hand-washing) 30	2	54	0,35

1) The load size is determined in accordance with the EN 60456 standard loads.

2) **Note:** Programme settings for tests in accordance with or in support of EN 60 456 and IEC 60 456.

Consumption values will vary from those quoted depending on the pressure and hardness of the water and its initial temperature, the room temperature, type and quantity of washing, detergent used, fluctuations in mains voltage and options selected.

## Installation and connection instructions



### Safety information concerning installation

- This washing machine **cannot be built-in**.
- Before using for the first time, check the appliance for damage sustained while it was being transported. Do not under any circumstances connect an appliance that is damaged to the mains. In the event of damage to the appliance contact your supplier.
- Be sure to remove all the components of the transit packaging before using the appliance for the first time. Otherwise when spinning damage may be caused to the appliance or to neighbouring units or furniture.
- Before using the appliance for the first time, splash protection must be completed. (See "Removing transit packaging").
- Always plug the mains plug into a correctly installed shockproof socket.
- If hard-wired: hard-wiring to the mains may only be carried out by an a qualified electrician.
- Prior to using the appliance for the first time, ensure that the rated voltage and current on the rating plate match the mains voltage and current where the appliance is to be installed. The required fuse protection is also to be found on the rating plate.
- If work on the plumbing is required for the proper connection of the washing machine to the water supply, this must be undertaken by a registered plumber.
- If work on the electricity supply system is required for the proper connection of the washing machine to the electricity supply, this must be undertaken by a registered electrician.
- The washing machine's mains cable must only be replaced by a Service Force Engineer



# Installing the appliance

## Transporting the appliance



**Warning:** The washing machine is very heavy. There is a risk of injury. Exercise care when lifting the appliance.

- Do not lay the washing machine on its front nor on its right side (as seen from the front). Electrical components may get wet.
- Never transport the appliance without using the transit packaging. Only remove the transit packaging when the appliance is in its place of installation. Transporting the appliance without the use of the transit packaging can cause damage to the appliance.
- Never lift the appliance by the door when it is open nor by the plinth.

**When using a sack trolley to transport the washing machine:**

- Only use the sack trolley on the side of the appliance.

## Removing the transit packaging

**Important!** Be sure to remove all the components of the transit packaging prior to using the appliance for the first time. Keep the transit packaging in a safe place, in case it is needed at a later date when the appliance is to be moved (e.g. moving house).

1. Open the two hose retainers located at the rear of the appliance and remove the hoses and electrical cable.
2. Remove the two hose retainers from the appliance with a strong tug.

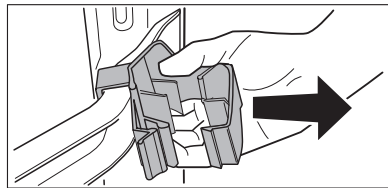
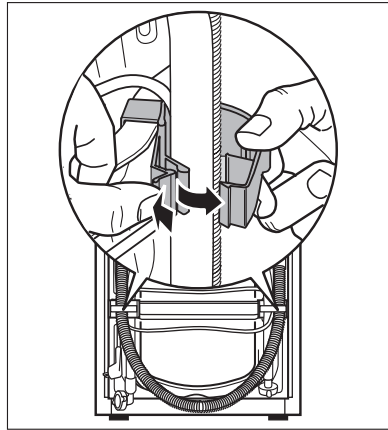

**i** Special spanner A and sealing caps B (2 units) and C (1 unit) come with the appliance.

3. Use special spanner A to remove screw D and the compression spring.
4. Use sealing cap C to cap the hole.
5. Use special spanner A to remove the two screws E.
6. Use special spanner A to remove the four screws F.
7. Remove transit bar G.
8. Screw in the four screws F again.
9. Use sealing caps B to cap the two large holes.

**Important:** Press all sealing caps B (2 items) and C (1 item) in firmly so that they snap into the rear wall.

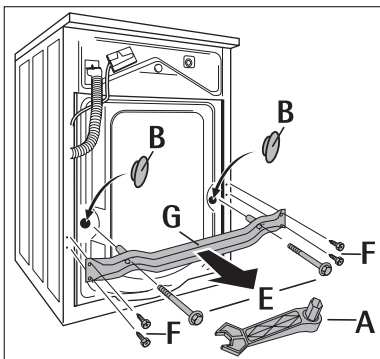
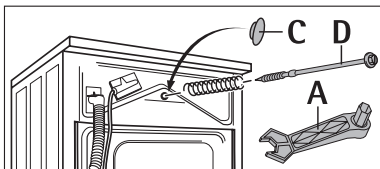

## Where to install

**Important!** The washing machine must not be operated in a room where there is a danger of frost. There is a risk of frost damage or adverse effect on the performance of the machine. Frost damage is not covered under the warranty.

- The surface on which the appliance is to be installed must be firm and level. Do not install the appliance on carpeted floors or soft floor coverings.
- The surface on which the appliance is to be installed must be clean and dry and free from grease, so that the appliance does not slide.
- If the location in which the appliance is to be installed is fitted with small-format tiles, put a rubber mat (available in the shops) under the appliance.

### **If the appliance is to stand on a floor which moves, e.g. a suspended wooden floor:**

Place the appliance in an area as close as possible to a corner of the room.

Screw a water-resistant wooden board (at least 15 mm thick) onto at least 2 of the floor joists.

## Making the appliance level

The four feet of the appliance are pre-adjusted. Large degrees of unevenness can be compensated for by adjusting the four feet of the appliance. Use the special spanner supplied to do this.

**Important:** Do not use pieces of wood, cardboard or such like to level out small degrees of unevenness in the floor. Adjust the adjustable feet instead.

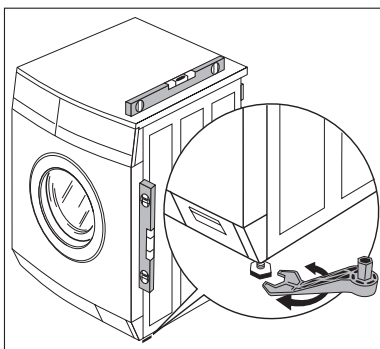

## Electrical Connection

Any electrical work required to install this appliance should be carried out by a qualified electrician or competent person.



### **WARNING – THIS APPLIANCE MUST BE EARTHED.**

The manufacturer declines any liability should these safety measures not be observed.

Before switching on, make sure the electricity supply voltage is the same as that indicated on the appliance rating plate.

The appliance is supplied with a 13 amp plug fitted. In the event of having to change the fuse in the plug supplied, a 13 amp ASTA approved (BS 1362) fuse must be used.

Should the plug need to be replaced for any reason, proceed as described below.

The wires in the mains lead are coloured in accordance with the following code:

Green and Yellow:	Earth
Blue:	Neutral
Brown:	Live

- The wire coloured green and yellow must be connected to the terminal marked with the letter "E" or by the earth symbol  $\oplus$  or coloured green and yellow.

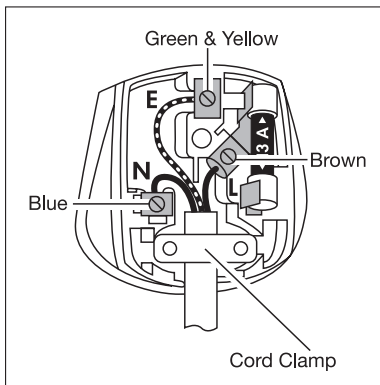

- The wire coloured blue must be connected to the terminal "N" or coloured black.
- The wire coloured brown must be connected to the terminal marked "L" or coloured red.
- Upon completion there must be no cut, or stray strands of wire present and the cord clamp must be secure over the outer sheath.



**WARNING!** A cut off plug inserted into a 13 amp socket is a serious safety (shock) hazard. Ensure that the cut off plug is disposed of safely.

## Permanent Connection

In the case of a permanent connection it is necessary that you install a double pole switch between the appliance and the electricity supply (mains), with a minimum gap of 3 mm between the switch contacts and of a type suitable for the required load in compliance with the current electrical regulations.

The switch must not break the yellow and green earth cable at any point.

This appliance complies with the requirements laid out in the EEC Directive 76/899.

Voltage 240 V AC: Fuse rating 13 amps

See rating plate for further information.

This appliance meets VDE requirements.

Particular regulations of local electricity authorities must be observed. This appliance conforms to EEC Directive No. 82/499/EWG on radio interference.



**WARNING!** Repairs to electrical appliances must only be carried out by trained personnel. Improper repairs may lead to serious risks for the user.

# Connecting the appliance to the water supply

## Important:

- This appliance must **not** be connected to the hot water supply.
- When connecting the appliance, use only new hose kits.
- Only connect the appliance to the drinking water supply. Rain water or water for industrial use may only be used if it fulfils the requirements of DIN 1986 and DIN 1988.
- Do not kink or crush the water inlet hose or drain hose.

## Permitted water pressure

The water pressure must be at least 1 bar ( $= 10\text{N}/\text{cm}^2 = 0.1\text{MPa}$ ), and may be a maximum of 10bar ( $= 100\text{N}/\text{cm}^2 = 1\text{MPa}$ ).

- If more than 10bar: Connect a pressure reduction valve.
- If less than 1 bar: Disconnect the appliance end of the inlet hose from the solenoid inlet valve and remove the flow meter. (In addition remove the filter using pointed pliers and take out the rubber gasket behind it.) Replace the filter.

## Water inlet

A 1.35m long pressure hose is supplied with the appliance.

If a longer inlet hose is required, only hoses from the manufacturer are to be used. Your local Service Force stocks hose kits of different lengths.



Sealing rings are either inserted in the plastic nuts of the threaded hose fitting or are included as spare parts. Do not use any other sealing rings.

**Important!** All threaded hose fittings must only be tightened by hand.

1. Connect the hose with the right-angle connector to the machine.

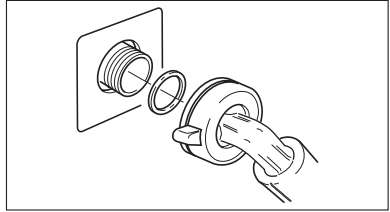

**Important!** Do not position the inlet hose vertically downwards. Position it to the right or the left as shown in the illustration.

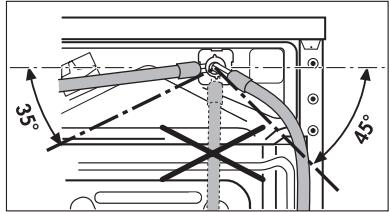

2. Connect the hose with the straight connector to a water tap with an R  $\frac{3}{4}$  (inch) screw thread.
3. Slowly turn on the tap and check that all connections are watertight.

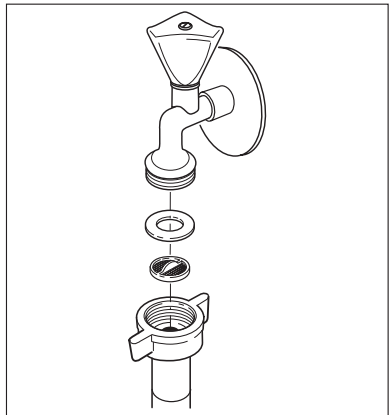

## Water Drainage

The appliance drain hose should hook into a standpipe, the hook in the drain hose is formed using the plastic "U-Piece" supplied. The standpipe should have an internal diameter of approximately 38 mm (see diagram) thus ensuring there is an air break between the drain hose and standpipe.

**Important!** It is essential to lay the drainage hose without kinks.

When discharging into a standpipe ensure that the top of the curve in the hose end is no more than 90 cm (35.4") and no less than 60 cm (23.6") above floor level.

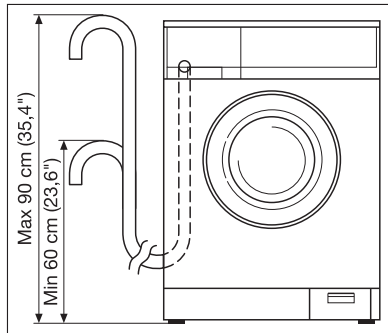

The upright standpipe should have a minimum, length of 30 cm (12") from the bottom of the elbow to the top of the pipe (see diagram). Make sure that it is designed in such a way that the end of the drain hose cannot be covered with water.

Longer drain hoses are available in lengths of 2.7 and 4 metres from your Service Force Centre.

**For drainage into an outlet spigot:** If the outlet spigot has not been used before, remove any blanking plug that may be in place. Push the drain hose onto the spigot and secure with a clip if required. Ensure the drain hose is looped upwards to prevent waste water from the sink entering the washing machine.

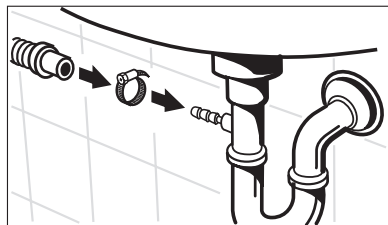
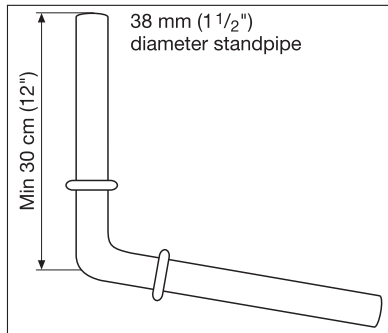

**Important!** The end of the drainage hose must not be submerged in the pumped-out water. Otherwise, the water could be sucked back into the appliance.

## **Pumping heights of over 1 metre**

The washing machine's drain pump is able to pump water to a height of 1 metre, calculated from the surface on which the appliance is installed.

**Important!** If pumping height is over 1 metre malfunctions and damage to the appliance may arise.

For pumping heights over 1 metre a conversion kit can be obtained. Please contact Service Force Centre.



# Warranty conditions

## Great Britain

### Standard guarantee conditions

We, AEG, undertake that if within 12 months of the date of the purchase this AEG appliance or any part thereof is proved to be defective by reason only of faulty workmanship or materials, we will, at our discretion repair or replace the same FREE OF CHARGE for labour, materials or carriage on condition that:

- The appliance has been correctly installed and used only on the electricity or gas supply stated on the rating plate.
- The appliance has been used for normal domestic purposes only, and in accordance with the manufacturer's operating and maintenance instructions.
- The appliance has not been serviced, maintained, repaired, taken apart or tampered with by any person not authorised by us.
- All service work under this guarantee must be undertaken by a Service Force Centre. Any appliance or defective part replaced shall become the Company's property.
- This guarantee is in addition to your statutory and other legal rights.
- Home visits are made between 8.30am and 5.30pm Monday to Friday. Visits may be available outside these hours in which case a premium will be charged.

### Exclusions

This guarantee does not cover:

- Damage or calls resulting from transportation, improper use or neglect, the replacement of any light bulbs or removable parts of glass or plastic.
- Costs incurred for calls to put right an appliance which is improperly installed or calls to appliances outside the United Kingdom.
- Appliances found to be in use within a commercial environment, plus those which are subject to rental agreements.
- Products of AEG manufacture which are not marketed by AEG.

### European Guarantee

If you should move to another country within Europe then your guarantee moves with you to your new home subject to the following qualifications:

- The guarantee starts from the date you first purchased your product.
- The guarantee is for the same period and to the same extent for labour and parts as exists in the new country of use for this brand or range of products.
- This guarantee relates to you and cannot be transferred to another user.
- Your new home is within the European Community (EC) or European Free Trade Area.
- The product is installed and used in accordance with our instructions and is only used domestically, i.e. a normal household.
- The product is installed taking into account regulations in your new country.

Before you move please contact your nearest Customer Care centre, listed below, to give them details of your new home. They will then ensure that the local Service Organisation is aware of your move and able to look after you and your appliances.

France	Senlis	+33 (0) 3 44 62 29 29
Germany	Nürnberg	+49 (0) 800 234 7378
Italy	Pordenone	+39 (0) 800 117511
Sweden	Stockholm	+46 (0) 8 672 5360
UK	Slough	+44 (0) 1753 219899





 **From the Electrolux Group. The world's No. 1 choice.**

*The Electrolux Group is the world's largest producer of powered appliances for kitchen, cleaning and outdoor use. More than 55 million Electrolux Group products (such as refrigerators, cookers, washing machines, vacuum cleaners, chain saws and lawn mowers) are sold each year to a value of approx. USD 14 billion in more than 150 countries around the world.*

AEG Hausgeräte GmbH  
Postfach 1036  
D-90327 Nürnberg

<http://www.aeg.hausgeraete.de>

© Copyright by AEG

105 176 195-00-140504-01

Subject to change without notice