

EN User manual

2

Dishwasher

USER MANUAL

ZDF3020

ZANUSSI

Get Living!

Contents

Safety information	2	Multitab function	10
Control panel	3	Select and start a washing programme	11
Washing programmes	5	Care and cleaning	12
Use of the appliance	6	What to do if...	13
Setting the water softener	6	Technical data	15
Use of dishwasher salt	7	Environment concerns	15
Use of rinse aid	8	Installation	15
Loading cutlery and dishes	8	Water connection	16
Use of detergent	10	Electrical connection	17

Subject to change without notice

Safety information

 For your safety and correct operation of the appliance, read this manual carefully before installation and use. Always keep these instructions with the appliance even if you move or sell it. Users must fully know the operation and safety features of the appliance.

Correct use

- The appliance is designed exclusively for domestic use.
- Only use the appliance to clean household utensils that are applicable for dishwashers.
- Do not put solvents in the appliance. Risk of explosion.
- Put the knives and all items with sharp points in the cutlery basket with their points down. If not, put in a horizontal position in the upper basket.
- Use only branded products for dishwashers (detergent, salt, rinse aid).
- If you open the door while the appliance is in operation, hot steam can escape. Risk of skin burns.
- Do not remove dishes from the dishwasher before the end of the washing programme.
- When the washing programme is completed, disconnect the mains plug from the mains socket and close the water tap.
- Only an authorised service engineer can repair this appliance. Use only original spare parts.
- Do not do repairs yourself to prevent injury and damage to the appliance. Always contact your local Service Force Centre.

General safety

- Persons (including children) with reduced physical sensory, mental capabilities or lack of experience and

knowledge must not use the appliance. They must have supervision or instruction for the operation of the appliance by a person responsible for their safety.

- Obey the safety instructions from the manufacturer of the dishwasher detergent to prevent burns to eyes, mouth and throat.
- Do not drink the water from the dishwasher. Detergent residues can stay in your appliance.
- Always close the door when you do not use the appliance to prevent injury and not to stumble over the open door.
- Do not sit or stand on the open door.

Child safety

- Only adults can use this appliance. Children must get supervision to make sure that they do not play with the appliance.
- Keep all the packaging away from children. There is a risk of suffocation.
- Keep all detergents in a safe area. Do not let children touch the detergents.
- Keep children away from the appliance when the door is open.

Installation

- Make sure that the appliance is not damaged because of transport. Do not connect a damaged appliance. If necessary, contact the supplier.
- Remove all packaging before first use.
- A qualified and competent person must do the electrical installation.
- A qualified and competent person must do the plumbing installation.

- Do not change the specifications or modify this product. Risk of injury and damage to the appliance.
- Do not use the appliance:
 - if the mains cable or water hoses are damaged,
 - if the control panel, worktop or plinth area are damaged, that you can get access to the inner side of the appliance.

Contact your local Service Force Centre.

- Do not drill into the sides of the appliance to prevent damage to hydraulic and electrical components.



Warning! Carefully obey the instructions for electrical and water connections.

Control panel

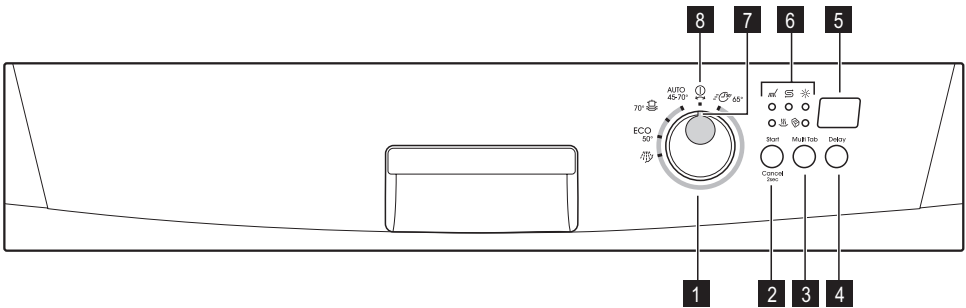

- 1** Programme knob
- 2** Start/cancel button
- 3** Multitab button
- 4** Delay start button
- 5** Digital display
- 6** Indicator lights
- 7** Programme marker
- 8** Off position

Indicator lights

Wash phase 	Comes on when the washing phase or the rinsing phase operates.
Dry phase 	Comes on when the drying phase operates.
Multitab 	Comes on when you activate the multitab function Refer to 'Multitab function'.
Salt ¹⁾ 	Comes on when it is necessary to fill the salt container. Refer to 'Use of dishwasher salt'. After you fill the container, the salt indicator light can continue to stay on for some hours. This does not have an unwanted effect on the operation of the appliance.

Indicator lights

Rinse aid ¹⁾



Comes on when it is necessary to fill the rinse aid container. Refer to 'Use of rinse aid'.

1) When the salt and/or rinse aid containers are empty, the related indicator lights do not come on while a washing programme operates.

Programme knob

- To switch on the appliance or to set a washing programme, turn the programme knob clockwise or counterclockwise. The programme marker on the programme knob must agree with one of the washing programmes on the control panel. If the programme marker agrees with a washing programme, the digital display shows the time duration of the programme. If the programme marker does not agree with a washing programme, the digital display shows two horizontal bars.
- To switch off the appliance, turn the programme knob until the programme marker agrees with the off indicator.

Use the programme knob for these operations:

- To set the water softener. Refer to 'Setting the water softener'.
- To deactivate/activate the rinse aid dispenser. Refer to 'Multitab function'.

Start/cancel button

Use the start/cancel button for these operations:

- To start the washing programme. Refer to the chapter 'Setting and starting a washing programme'.
- To cancel a washing programme in progress. Refer to the chapter 'Setting and starting a washing programme'.
- To set the water softener level. Refer to the chapter 'Set the water softener'.
- To deactivate/activate the rinse aid dispenser. Refer to the chapter 'Multitab function'.

Multitab button

Press this button to activate/deactivate the multitab function. Refer to the chapter 'Multitab function'.

Delay start button

Use the delay start button to delay the start of the washing programme with an interval between 1 and 19 hours. Refer

to the chapter 'Setting and starting a washing programme'.

Digital display

The display shows:

- Adjusted level of the water softener.
- Activation/deactivation of the rinse aid dispenser (only with multitab function on).
- Programme duration.
- Remaining time to the end of the programme.
- End of a washing programme, the digital display shows a zero.
- Number of hours in delay start.
- Fault codes.

Setting mode

The appliance is in setting mode when:

- One or more phase indicator lights are on.
- The time duration of the programme flashes in the digital display.

The appliance must be in setting mode for these operations:

- To set a washing programme.
- To set the water softener level.
- To deactivate/activate the rinse aid dispenser.



The appliance is not in setting mode when:

- One or more phase indicator lights are on.
- The time duration of the programme does not flash.

In this condition cancel the programme to go back to the setting mode. Refer to the chapter 'Setting and starting a washing programme'.

Washing programmes

Washing programmes



Programme and programme knob position	Degree of soil	Type of load	Programme description
AUTO ¹⁾	Any	Crockery, cutlery, pots and pans	Prewash Main wash up to 45°C or 70°C 1 or 2 intermediate rinses Final rinse Drying
	Heavy soil	Crockery, cutlery, pots and pans	Prewash Main wash up to 70°C 2 intermediate rinses Final rinse Drying
ECO ²⁾	Normal soil	Crockery and cutlery	Prewash Main wash up to 50°C 1 intermediate rinse Final rinse Drying
	Any	Partial load (to be completed later in the day).	1 cold rinse (to prevent food scraps to bond). Detergent is not necessary with this programme.
	Normal or light soil	Crockery and cutlery	Main wash up to 65°C Final rinse

1) During the Auto programme, the soil level of the dishes is given by how cloudy the water is. The programme duration and consumptions can change. This depends if the appliance is fully or not and on the level of soil on the dishes. The appliance adjusts automatically the temperature of the water during the main wash.

2) Test programme for test institutes. Please refer to separate leaflet supplied, for test data.

3) This is the perfect daily programme to clean a not fully load. Ideal for a family of 4 persons who only want to load breakfast and dinner crockery and cutlery.

Consumption values

Programme	Duration (in minutes) ¹⁾	Energy (in kWh)	Water (in litres)
AUTO	-	1,1-1,7	11-22
	-	1,6-1,8	22-24
ECO	-	1,0-1,1	13-15
	-	0,1	4
	-	0,9	9

1) The digital display shows the programme duration.

i The pressure and temperature of the water, the variations of power supply and the quantity of dishes can change these values.

Use of the appliance

Refer to the following instructions for each step of procedure:

1. Make a check if the water softener level is correct for the water hardness in your area. If necessary set the water softener.
2. Fill the salt container with dishwasher salt.
3. Fill the rinse aid dispenser with rinse aid.
4. Load cutlery and dishes into the dishwasher.

5. Set the correct washing programme for the type of load and soil.
6. Fill the detergent dispenser with the correct quantity of detergent.
7. Start the washing programme.

i If you use combi detergent tablets ('3 in 1', '4 in 1', '5 in 1', etc.), refer to the chapter 'Multitab function'.

Setting the water softener

The water softener removes minerals and salts from the water supply. Minerals and salts can have bad effect on the operation of the appliance.

Water hardness is measured in equivalent scales:

- German degrees (dH°).
- French degrees (°TH).

- mmol/l (millimol per litre - international unit for the hardness of water).

- Clarke.

Adjust the water softener to the water hardness in your area. If necessary, contact your local water authority.

Water hardness				Water hardness setting	
°dH	°TH	mmol/l	Clarke	manually	electronically
51 - 70	91 - 125	9,1 - 12,5	64 - 88	2	10
43 - 50	76 - 90	7,6 - 9,0	53 - 63	2	9
37 - 42	65 - 75	6,5 - 7,5	46 - 52	2	8
29 - 36	51 - 64	5,1 - 6,4	36 - 45	2	7
23 - 28	40 - 50	4,0 - 5,0	28 - 35	2	6
19 - 22	33 - 39	3,3 - 3,9	23 - 27	2	5
15 - 18	26 - 32	2,6 - 3,2	18 - 22	1	4
11 - 14	19 - 25	1,9 - 2,5	13 - 17	1	3
4 - 10	7 - 18	0,7 - 1,8	5 - 12	1	2
< 4	< 7	< 0,7	< 5	1 ¹⁾	1 ¹⁾

1) No use of salt required.

i You must set the water softener manually and electronically.

Manual adjustment

The appliance is set at the factory at position 2.

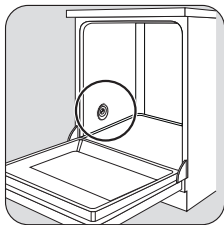

1

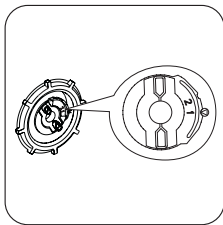

2

Set switch to position 1 or 2.

Electronic adjustment

The water softener is set at the factory at level 5.

i The appliance must be switched off.

Use of dishwasher salt

! **Caution!** Only use dishwashers salt. Types of salt that are not applicable for dishwashers cause damage to the water softener.

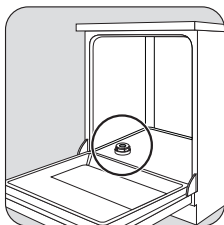

1

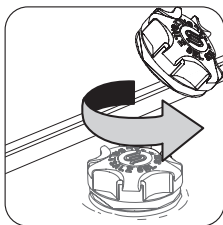

2



3

Fill the salt container with 1 litre of water (only the first operation).

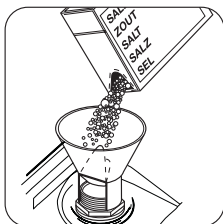

4

1. Press and hold the start/cancel button. Turn the programme knob counterclockwise until the programme marker agrees with the first washing programme on the control panel.
2. Release the start/cancel button when the digital display shows the current setting.
Examples:
 - level 5 = **5 L**
 - level 10 = **10 L**
3. Press the start/cancel button to change the water softener level. Every time you press the button, the level increases.
4. Turn the programme knob to the off position to save the operation.

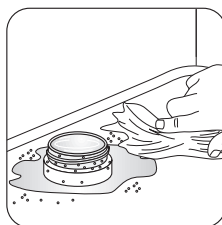

5

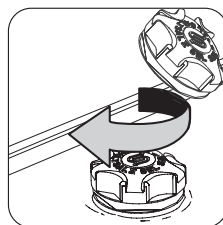

6

i It is normal that water overflows from the salt container when you fill it with salt.

i Make sure that there is no grain of salt outer of the salt compartment. Salt which stays on the tank for a while drills the tank. It is recommended to start a washing programme immediately after you fill the salt container. This prevents of corrosion because of spilled salt.

When you set electronically the water softener to level 1, the salt indicator light does not stay on.

Use of rinse aid

Caution! Only use branded rinse aid for dishwashers.

Do these steps to fill the rinse aid dispenser:

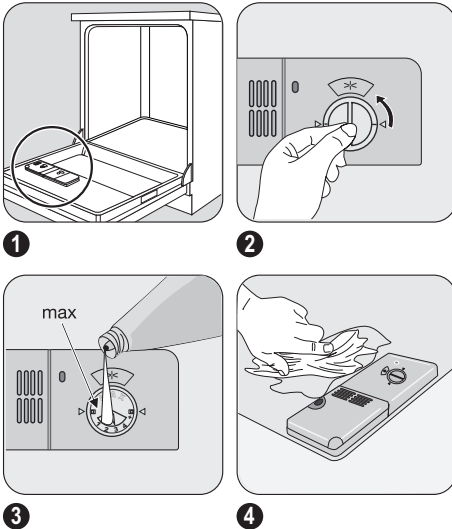

Caution! Do not fill the rinse aid dispenser with other products (e.g. dishwasher cleaning agent, liquid detergent). There is a risk of damage to the appliance.

Adjusting the dosage of rinse aid

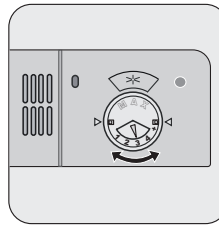

The rinse aid dial is set at the factory at position 3. To increase or decrease the dosage refer to 'What to do if...'

Loading cutlery and dishes

Helpful hints and tips

Caution! Only use the appliance for household utensils that are applicable for dishwashers.

Do not use the appliance to clean objects that can absorb water (sponges, household cloths, etc.).

- Before you load cutlery and dishes, do these steps:
 - Remove all food remainings and debris.
 - Make burnt, remaining food in pans soft.
- While you load cutlery and dishes, do these steps:
 - Load hollow items (e.g. cups, glasses and pans) with the opening down.
 - Make sure that water does not collect in the container or in a deep base.
 - Make sure that cutlery and dishes do not lie inside one another.
 - Make sure that cutlery and dishes do not cover other cutlery and dishes.

- Make sure that glasses do not touch other glasses.
- Put small objects in the cutlery basket.

- Plastic items and pans with non-stick coatings can keep water droplets. Plastic items do not dry as well as porcelain and steel items.
- Put light items in the upper basket. Make sure that the items do not move.

Caution! Make sure that the spray arms can move freely before you start a washing programme.

Warning! Always close the door after you load or unload the appliance. An open door can be dangerous.

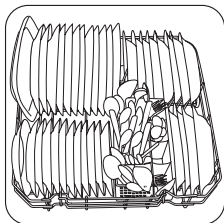

1
Arrange service dishes and large lids around the edge of the lower basket.

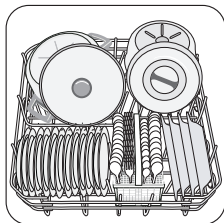

2

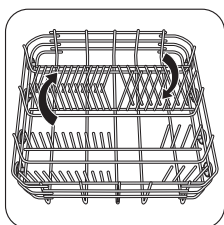

3
The rows of prongs in the lower basket can be flat to load pots, pans and bowls.

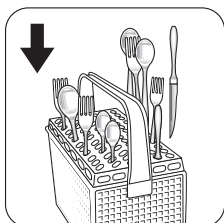

1

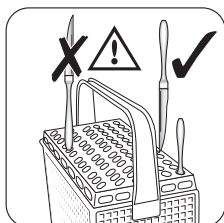

2

i Use the cutlery grid. If the dimensions of the cutlery prevent use of the cutlery grid, remove it.

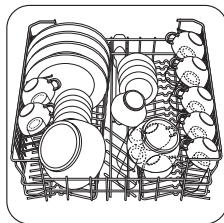

1
Arrange the items to let water touch all surfaces.

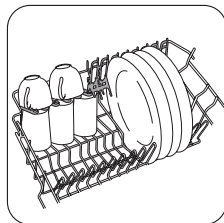

2
For longer items fold the cup racks up.

i Prevent to put plates in the first three sections in the front part of the upper basket. Make sure the plates tilt forward.

Adjustment of the height of the upper basket

If you put large plates in the lower basket, first move the upper basket to the upper position.

Maximum height of the dishes		
	upper basket	lower basket
Upper position	20 cm	31 cm
Lower position	24 cm	27 cm

Do these steps to move the upper basket to the upper position:

1. Pull the basket out until it stops.
2. Carefully lift the two sides until the mechanism is engaged and the basket is stable.

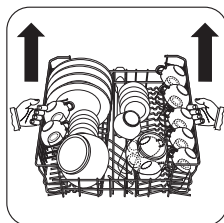

1

Do these steps to move the upper basket to the lower position:

1. Pull the basket out until it stops.
2. Carefully lift the two sides upwards.
3. Hold the mechanism and let it fall back down slowly.

⚠ Caution!

- Do not lift or lower the basket on one side only.

Use of detergent

i Only use detergents (powder, liquid or tablet) that are applicable for dishwashers.

Follow the data on the packaging:

- Dosage recommended by the manufacturer.
- Storage recommendations.

🌿 Do not use more than the correct quantity of detergent to save an environment.

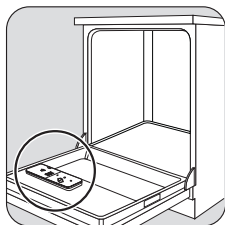

1

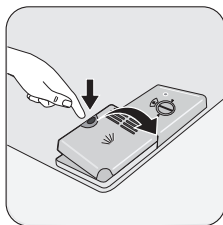

2

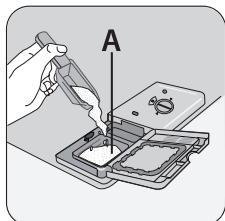

3

Fill the detergent dispenser (A) with detergent.

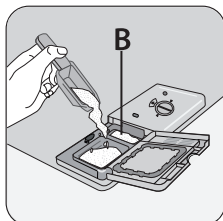

4

If you use a washing programme with prewash phase, put more detergent in the prewash detergent compartment (B).

- If the basket is in the upper position, do not put cups on the cup racks.

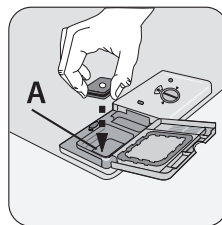

5

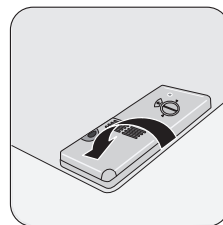

6

i Different brands of detergent dissolve in different times. Some detergent tablets do not have the best cleaning results during short washing programmes. Use long washing programmes when you use detergent tablets to fully remove the detergent.

Multitab function

The multitab function is for combi detergent tablets. These tablets contain agents such as detergent, rinse aid and dishwasher salt. Some types of tablets can contain other agents.

Do a check if these tablets are applicable for the local water hardness. Refer to the instructions from the manufacturer. When you set the multitab function, it stays on until you deactivate it.

The multitab function stops automatically the flow of rinse aid and salt. The rinse aid indicator light and salt indicator light are deactivated.

The programme duration can increase if you use the multitab function.

- i** Activate or deactivate the multitab function before the start of a washing programme.

You cannot activate or deactivate the multitab function when the programme operates. Cancel the washing programme, then set the programme again.

To activate the multitab function:

- Press the multitab button. The multitab indicator light comes on.

To deactivate the multitab function:

- Press the multitab button. The multitab indicator light goes off.

- i** **Do these steps if the drying results are not satisfactory:**

1. Fill the rinse aid dispenser with rinse aid.
 2. Activate the rinse aid dispenser.
 3. Set the rinse aid dosage to position 2.
- You can only activate or deactivate the rinse aid dispenser when the multitab function is activated.

To activate/deactivate the rinse aid dispenser:

- i** The appliance must be switched off.

1. Press and hold the start/cancel button. Turn the programme knob counterclockwise until the programme marker agrees with the first washing programme on the control panel.

2. Release the start/cancel button when the display shows the water hardness level.
3. Turn the programme knob counterclockwise until the programme marker agrees with the second washing programme on the control panel.
4. The digital display shows the current setting for the rinse aid dispenser.

<i>0 d</i>	Rinse aid dispenser deactivated
<i>1 d</i>	Rinse aid dispenser activated

5. Press the start/cancel button to change the setting. The digital display shows the new setting.
6. Turn the programme knob to the off position to save the operation.

- i** To use normal detergent again:

1. Deactivate the multitab function.
2. Fill the salt container and rinse aid dispenser.
3. Adjust the water hardness setting to the highest level.
4. Do a washing programme without dishes.
5. Adjust the water softener to the water hardness in your area.
6. Adjust the rinse aid dosage.

Select and start a washing programme

Do these steps to set and start a washing programme:

1. Close the door.
2. Turn the programme knob to set the washing programme. Refer to the chapter 'Washing programmes'.
 - The phase indicator light or lights for the washing programme come on.
 - The programme duration in the digital display flashes.
3. Press the start/cancel button.
 - The washing programme starts automatically.
 - When the programme starts, only the indicator light of the phase in progress stays on. Programme duration is on with a static light.

- i** When the washing programme operates, you cannot change the programme. Cancel the washing programme.

! **Warning!** Only interrupt or cancel a washing programme if necessary.

! **Caution!** Open the door carefully. Hot steam can come free.

Interrupting a washing programme

Open the door.

- The programme stops.

Close the door.

- The programme continues from the point of interruption.

Cancelling a washing programme

- Press and hold the start/cancel button.
 - In the digital display the time duration of the programme flashes.
 - One or more phase indicator lights are on.

The washing programme is cancelled.

At this time you can do these steps:

1. Switch off the appliance.
2. Set a new washing programme.

Fill the detergent dispenser with detergent before you set a new washing programme.

Setting and starting a washing programme with delay start

1. Set a washing programme.
2. Press the delay start button until the display shows the necessary delay start time for the washing programme. Delay start time flashes in the digital display.
3. Press the start/cancel button.
 - The countdown of the delay start starts.
 - The phase indicator lights of the washing programme go off.
 - In the digital display the delay start time is on with a static light.

When the countdown is completed, the washing programme automatically starts. The phase indicator light of the phase in progress comes on.

i Do not open the door during the countdown to prevent interruption of the countdown. When you close the door again, the countdown continues from the point of interruption.

Care and cleaning

Warning! Switch the appliance off before you clean the filters.

Cleaning the filters

Important! Do not use the appliance without the filters. Make sure that the installation of the filters is correct. Incorrect installation will cause unsatisfactory washing results and damage to the appliance.

Cancelling a delay start

1. Press and hold the start/cancel button.
 - The phase indicator lights or light come on.
 - In the digital display, the time duration of the washing programme comes on.
2. Press the start/cancel button to start the washing programme.

End of the washing programme

Switch off the appliance in these conditions:

- The appliance stops automatically.
- The digital display shows a zero.
- The phase indicator lights are off.

For better drying results, keep the door ajar for some minutes before you remove the dishes.

Let the dishes cool down before you remove them from the appliance. Hot dishes are easily damaged.

Standby mode

If you do not switch off the appliance at the end of the washing programme, the appliance automatically goes into standby mode. The standby mode decreases energy consumption.

Three minutes after the end of the programme, all indicator lights go off and the digital display shows one horizontal bar.

Press a button to go back to the end-of-programme mode.

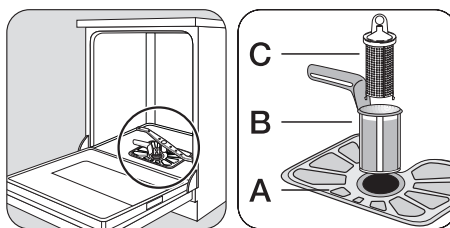

1

2

Fully clean the filters A, B and C below running water.

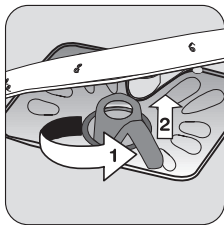

3 To remove filters B and C, turn the handle approximately 1/4 anticlockwise.

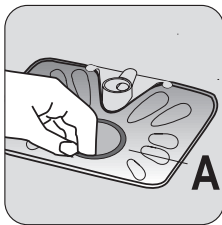

4 Remove the flat filter A from the bottom of the appliance.

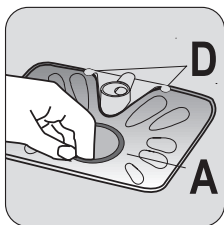

5 Put the flat filter A in the bottom of the appliance. Install the flat filter correctly under the two guides D.

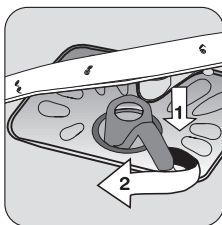

6 Put the filter system in position. To lock the filter system, turn the handle clockwise until it locks in position.

Important! Do not remove the spray arms.

If the holes in the spray arms become clogged, remove remaining parts of soil with a cocktail stick.

External cleaning

Clean the external surfaces of the appliance and control panel with a damp soft cloth. Only use neutral detergents. Do not use abrasive products, scouring pads or solvents (acetone, trichloroethylene etc...).

Frost precautions

! **Caution!** Do not install the appliance where the temperature is below 0 °C. The manufacturer is not responsible for damage because of frost.

If not possible, empty the appliance and close the door. Disconnect the water inlet hose and remove water from the water inlet hose.

What to do if...

The appliance does not start or stops during operation. If there is a fault, first try to find a solution to the problem yourself. If you cannot find a solution to the problem yourself, contact the Service Force Centre.

! **Caution!** Switch off the appliance before you do the below suggested corrective actions.

Fault code and malfunction	Possible cause and solution
<ul style="list-style-type: none"> the digital display shows 10 The dishwasher does not fill with water	<ul style="list-style-type: none"> The water tap is blocked or furred with limescale. Clean the water tap. The water tap is closed. Open the water tap. The filter in the water inlet hose is blocked. Clean the filter. The connection of the water inlet hose is not correct. The hose can be kinked or squashed. Make sure that the connection is correct.

Fault code and malfunction	Possible cause and solution
<ul style="list-style-type: none"> the digital display shows ,20 The dishwasher will not drain 	<ul style="list-style-type: none"> There is a blockage in the sink spigot. Clean the sink spigot. The connection of the water drain hose is not correct. The hose can be kinked or squashed. Make sure that the connection is correct.
<ul style="list-style-type: none"> the digital display shows ,30 The anti-flood device operates 	<ul style="list-style-type: none"> Close the water tap and contact your local Service Force Centre.
The programme does not start	<ul style="list-style-type: none"> The appliance door is not closed. Close the door. Mains plug is not connected in. Put in the mains. The fuse has blown out in the household fuse box. Replace the fuse. Delay start is set. Cancel the delay start to start the programme immediately.

After the check, switch on the appliance. Set the knob on the same washing programme as before the malfunction. The programme continues from the point of interruption. If the malfunction shows again, contact your Service Force Centre.

If the display shows a fault code, not described in the chart, contact your Service Force Centre.

These data are necessary to help you quickly and correctly:

- Model (Mod.)
 - Product number (PNC)
 - Serial number (S.N.)
- For these data, refer to the rating plate.
Write the necessary data here:
Model description :
Product number :
Serial number :

The cleaning results are not satisfactory	
The dishes are not clean	<ul style="list-style-type: none"> The selected washing programme is not applicable for the type of load and soil. The baskets are loaded incorrectly so that water cannot reach all surfaces. Spray arms do not turn freely because of incorrect arrangement of the load. The filters are dirty or not correctly installed. The quantity of detergent is too little or missing.
Limescales particles on the dishes	<ul style="list-style-type: none"> The salt container is empty. The water softener is adjusted on a wrong level. The salt container cap is not closed correctly.
The dishes are wet and dull	<ul style="list-style-type: none"> No rinse aid has been used. The rinse aid dispenser is empty.
There are streaks, milky spots or a bluish coating on glasses and dishes	<ul style="list-style-type: none"> Decrease the rinse aid dosage.

The cleaning results are not satisfactory

Dry water drop signs on glasses and dishes

- Increase rinse aid dosage.
- The detergent can be the cause.

Technical data

Dimensions	Width cm	60
	Height cm	85
	Depth cm	61
Electrical connection - Voltage - Overall power - Fuse	Information on the electrical connection is given on the rating plate on the inner edge of the dishwasher door.	
Water supply pressure	Minimum	0,5 bar (0,05 MPa)
	Maximum	8 bar (0,8 MPa)
Capacity	Place settings	12

Environment concerns

The symbol  on the product or on its packaging indicates that this product may not be treated as household waste. Instead it should be taken to the appropriate collection point for the recycling of electrical and electronic equipment. By ensuring this product is disposed of correctly, you will help prevent potential negative consequences for the environment and human health, which could otherwise be caused by inappropriate waste handling of this product. For more detailed information about recycling of this product, please contact your local council, your household waste disposal service or the shop where you purchased the product.

The packaging materials are environmentally friendly and can be recycled. The plastic components are identified by

markings, e.g. >PE<, >PS<, etc. Discard the packaging materials in the applicable container at the community waste disposal facilities.

 **Warning!** To discard the appliance, follow the procedure:

- Pull the mains plug out of the socket.
- Cut off the mains cable and mains plug and discard them.
- Discard the door catch. This prevents the children to close themselves inside the appliance and endanger their lives.

Installation

 **Warning!** Make sure that mains plug is disconnected from the mains socket during installation.

Fitting under a counter

Put the appliance adjacent to a water tap and a water drain. Remove the appliance worktop to install it under a sink unit or a kitchen worktop. Make sure that the dimensions of the recess agree with the given dimensions.

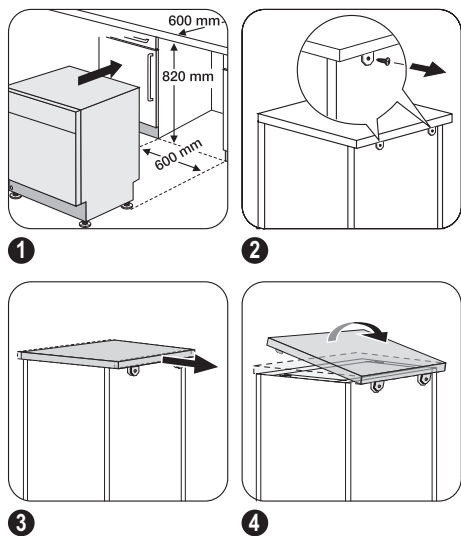

Install the appliance worktop to the appliance if you want to use the dishwasher as a freestanding appliance. The plinth on freestanding appliance is not adjustable.

Adjusting the level of the appliance

Make sure that the appliance is level to close and seal the door correctly. If the level of the appliance is correct, the door does not catch on the sides of the cabinet. If the door does not close correctly, loosen or tighten the adjustable feet until the appliance is level.

Water connection

Water inlet hose

Connected the appliance to a cold water supply. Connect the inlet hose to a water tap with an external thread of 3/4".

Caution! Do not use connection hoses from an old appliance.

The water pressure must be in the limits (refer to the chapter "Technical data"). Make sure that the local water authority gives you the average mains pressure in your area.

Make sure that there are no kinks in the water inlet hose and that the water inlet hose is not squashed or entangled. Turn the inlet hose to the left or the right to suit the installation. Fit the locknut correctly to prevent water leaks.

Caution! Do not connect the appliance to new pipes or pipes that are not used for a long time. Let the water run for some minutes, then connect the inlet hose.

Drain hose

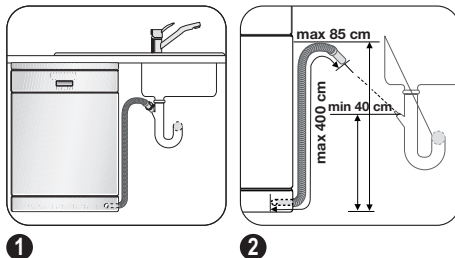

Connect the water drain hose to the sink spigot.

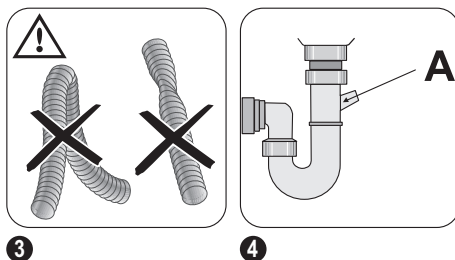

The internal diameter must not be smaller than the diameter of the hose.

If you connect the water drain hose to a trap spigot under the sink, remove the plastic membrane (A). If you do not remove the membrane, remaining food can cause a blockage in the drain hose spigot.



Caution! Make sure that the water couplings are tight to prevent water leakage.

Electrical connection



Warning! The manufacturer is not responsible if you do not follow these safety precautions.

This appliance needs to be earthed according to safety precautions.

Make sure that the rated voltage and type of power on the rating plate agree with the voltage and the power of the local power supply.

Always use a correctly installed shockproof socket.

Do not use multi-way plugs, connectors and extension cables. There is a risk of fire.

Do not replace the mains cable yourself. Contact the Service Force Centre.

Make sure that the mains plug is accessible after installation.

Do not pull the mains cable to disconnect the appliance. Always pull the mains plug.



Warning! The appliance is supplied with a 13 amp plug attached. Use a 13 amp ASTA approved (BS 1362) fuse if it is necessary to change the fuse in the plug supplied.

To buy accessories, consumables and spare parts at our online shop please visit:
www.zanussi.co.uk

156985781-00-082009