

4S645

USER'S MANUAL

M/B For Socket 478 Pentium 4 Processor

NO. G03-4S645R3A

Release date: July 2002

Trademark:

* Specifications and Information contained in this documentation are furnished for information use only, and are subject to change at any time without notice, and should not be construed as a commitment by manufacturer.

TABLE OF CONTENT

USER'S NOTICE	ii
MANUAL REVISION INFORMATION.....	1
COOLING SOLUTIONS	1
CHAPTER 1 INTRODUCTION OF 4S645 MOTHERBOARD	
1-1 FEATURE OF MOTHERBOARD.....	2
1-2 SPECIFICATION	3
1-3 PERFORMANCE LIST	4
1-4 LAYOUT DIAGRAM & JUMPER SETTING	5
CHAPTER 2 HARDWARE INSTALLATION	
2-1 HARDWARE INSTALLATION STEPS.....	7
2-2 CHECKING MOTHERBOARD'S JUMPER SETTING	7
2-3 INSTALL CPU	8
2-3-1 GLOSSARY.....	8
2-3-2 ABOUT INTEL PENTIUM 4 478-PIN CPU	9
2-4 INSTALL MEMORY	10
2-5 EXPANSION CARD.....	11
2-5-1 PROCEDURE FOR EXPANSION CARD INSTALLATION	11
2-5-2 ASSIGNING IRQ FOR EXPANSION CARD	11
2-5-3 INTERRUPT REQUEST TABLE FOR THIS MOTHERBOARD	12
2-5-4 AGP SLOT	12
2-6 CONNECTORS, HEADERS.....	12
2-6-1 CONNECTORS	12
2-6-2 HEADERS	15
2-7 STARTING UP YOUR COMPUTER.....	19
CHAPTER 3 INTRODUCING BIOS	
3-1 ENTERING SETUP	20
3-2 GETTING HELP.....	21
3-3 THE MAIN MENU	21
3-4 STANDARD CMOS FEATURES.....	22
3-5 ADVANCED BIOS FEATURES	24
3-6 ADVANCED CHIPSET FEATURES	26
3-6-1 DRAM TIMING SETTINGS.....	27
3-6-2 AGP FUNCTION SETTINGS	28
3-7 INTEGRATED PERIPHERALS.....	28
3-7-1 ONCHIP IDE FUNCTION.....	29
3-7-2 ONCHIP DEVICE FUNCTION	30
3-7-3 ONCHIP SUPERIO FUNCTION	31
3-8 POWER MANAGEMENT SETUP.....	32
3-8-1 PM WAKE UP EVENTS	33
3-9 PNP/PCI CONFIGURATION SETUP.....	34

3-9-1	IRQ RESOURCES	35
3-10	PC HEALTH STATUS	35
3-11	MISCELLANEOUS CONTROL.....	36
3-12	LOAD STANDARD/OPTIMIZED DEFAULTS	37
3-13	SET SUPERVISOR/USER PASSWORD	37

CHAPTER 4 DRIVER & FREE PROGRAM INSTALLATION

MAGIC INSTALL SUPPORTS WINDOWS 95/98/98SE/NT4.0/2000.....	38
4-1 AGPVXD INSTALL SIS AGPVXD DRIVER	39
4-2 SOUND INSTALL ALC201 AUDIO CODEC DRIVER.....	40
4-3 PC-HEALTH WINBOND HARDWARE DOCTOR MONITORING SOFTWARE	41

USER'S NOTICE

COPYRIGHT OF THIS MANUAL BELONGS TO **THE MANUFACTURER**. NO PART OF THIS MANUAL, INCLUDING THE PRODUCTS AND SOFTWARE DESCRIBED IN IT MAY BE REPRODUCED, TRANSMITTED OR TRANSLATED INTO ANY LANGUAGE IN ANY FORM OR BY ANY MEANS WITHOUT WRITTEN PERMISSION OF **THE MANUFACTURER**.

THIS MANUAL CONTAINS ALL INFORMATION REQUIRED TO USE 4S645 MOTHERBOARD AND WE DO ASSURE THIS MANUAL MEETS USER'S REQUIREMENT BUT WILL CHANGE, CORRECT ANY TIME WITHOUT NOTICE. **MANUFACTURER** PROVIDES THIS MANUAL "AS IS" WITHOUT WARRANTY OF ANY KIND, AND WILL NOT BE LIABLE FOR ANY INDIRECT, SPECIAL, INCIDENTAL OR CONSEQUENTIAL DAMAGES (INCLUDING DAMAGES FOR LOSS OF PROFIT, LOSS OF BUSINESS, LOSS OF USE OF DATA, INTERRUPTION OF BUSINESS AND THE LIKE).

PRODUCTS AND CORPORATE NAMES APPEARING IN THIS MANUAL MAY OR MAY NOT BE REGISTERED TRADEMARKS OR COPYRIGHTS OF THEIR RESPECTIVE COMPANIES, AND THEY ARE USED ONLY FOR IDENTIFICATION OR EXPLANATION AND TO THE OWNER'S BENEFIT, WITHOUT INTENT TO INFRINGE.

Manual Revision Information

Reversion	Revision History	Date
3.0	Third Edition	July 2002

Item Checklist

- 4S645 motherboard
- Cable for IDE/Floppy
- CD for motherboard utilities
- Cable for USB Port 3/4 (Option)
- 4S645 User's Manual

Intel Pentium 4 Processor Family Cooling Solutions

As processor technology pushes to faster speeds and higher performance, thermal management becomes increasingly crucial when building computer systems. Maintaining the proper thermal environment is key to reliable, long-term system operation. The overall goal in providing the proper thermal environment is keeping the processor below its specified maximum case temperature. Heatsinks induce improved processor heat dissipation through increased surface area and concentrated airflow from attached fans. In addition, interface materials allow effective transfers of heat from the processor to the heatsink. For optimum heat transfer, Intel recommends the use of thermal grease and mounting clips to attach the heatsink to the processor.

When selecting a thermal solution for your system, please refer to the website below for collection of heatsinks evaluated and recommended by Intel for use with Intel processors. Note, those heatsinks are recommended for maintaining the specified Maximum T case requirement. In addition, this collection is not intended to be a comprehensive listing of all heatsinks that support Intel processors.

For vendor list of heatsink and fan, please visit :
<http://developer.intel.com/design/Pentium4/components/index>

Chapter 1

Introduction of 4S645 Motherboard

1-1 Feature of motherboard

The 4S645 motherboard is design for use Intel Pentium 4 Processor in 478 Pin Package/Northwood Processor with the SiS 645 Chipset delivers a high performance and professional desktop platform solution. Which utilize the Socket 478 design and the memory size expandable to 3.0GB.

This motherboard use the newest SiS 645 Chipset Supports 400MHz System Bus in data transfer rate and 100MHz/133MHz/166MHz SDRAM clock frequency support DDR200/DDR266/DDR333 DDR SDRAM Module . The 4S645 motherboard offers ULTRA ATA **100** to provide speedier HDD throughout that boosts overall system performance.

The motherboard also has an integrated AC'97 2.1 CODEC on board which is fully compatible with Sound Blaster Pro[®] that gives you the best sound quality and compatibility.

For those wanting even greater graphic performance, an AGP 4X slot is included on the board.

With USB control as well as capability of expanding to 4 USB function ports, the 4S645 meet future USB demand also this motherboard has built-in hardware monitor function to monitor and protect your computer.

This motherboard can conditional support traditional ATX Power Supply, if the 12V output of Power Supply can offer more than 120W, let you have more choice when use Power Supply.

We use three phase design in CPU Vcore Voltage let CPU Voltage more stable when CPU full speed running.

By Magic Install CD, users can install system drivers easily and friendly, and the Magic BIOS Utility can offer BIOS live update from web, auto detected BIOS version to prevent update wrong BIOS.

In 4S645, we have CPU Host clock step-by-step increment designs in BIOS Setup Utility to increasing CPU Host Clock let users approach over clock demand.

4S645 provides high performance & meets future specification demand. It is really wise choice for your computer.

1-2 Specification

Spec	Description
Design	* ATX form factor 4 layers PCB size: 30.5x21.0cm
Chipset	* SiS 645 North Bridge Chipset * SiS 961 HyperZip Media I/O Chipset
CPU Socket (mPGA478B Socket)	* Support Intel Pentium 4 478 Pin package utilizes Flip-Chip Pin Grid Array (FC-PGA2) package processor * Support 1.5G~2.2G 478 Pin Pentium 4 processor * Reserves support for future Intel Pentium 4 processors
Memory Socket	* 184-pin DDR SDRAM module socket x3 * Support 2 pcs DDR333 or 3 pcs DDR200/DDR266 DDR SDRAM Modules * Expandable to 3.0GB
Expansion Slot & Headers	* AGP slot x1 support AGP 2.0 & 4X mode * 32-bit PCI slot x5 * CNR slot x1
Integrate IDE	* Two PCI IDE controllers support PCI Bus Mastering, ATA PIO/DMA and the ULTRA DMA 33/66/100 functions that deliver the data transfer rate up to 100 MB/s
Audio	* AC'97 Digital Audio controller integrated * AC'97 Audio CODEC on board * Audio driver and utility included
BIOS	* Award 2MB Flash ROM
Multi I/O	* PS/2 keyboard and PS/2 mouse connectors * Floppy disk drive connector x1 * Parallel port x1 * Serial port x2 * USB connector x2 * USB headers x2 (connecting cable option) * Audio connector (Line-in, Line-out , MIC & Game Port)

1-3 Performance List

The following performance data list is the testing result of some popular benchmark testing programs. These data are just referred by users, and there is no responsibility for different testing data values gotten by users (the different Hardware & Software configuration will result in different benchmark testing results.)

Performance Test Report

CPU: Intel Pentium 4 1.9GHz mPGAB package
DRAM: 128M DDR266 x2 (SAMSUNG K4H280838B-TCB0)
 256M DDR333 x1 (KINGMAX KDL684T4A2A-6)
VGA Expansion Card: NVIDIA Geforce2 MX-400 64MB (1024x768xHi-color)
Hard Disk Driver: IBM DTLA-305040 (ATA-100)
BIOS: Award Optimal default
OS: Win 98SE

Performance Test Report

	DDR266	DDR333
3D Mark 2000	5369	5477
3D Mark 2001	2492	2519
3D Winbench 2000	103	104
Final Reality	9.76	10.60
Content Creation Winstone 2000	42.5	43.6
Content Creation Winstone 2001	52.7	53.6
Business Winstone2001	45.1	46.7
Winbench 99:		
CPU Mark 99	109	114
FPU Winmark 99	6600	6610
Business Disk Winmark99	7650	8980
Hi-end Disk Winmark99	19000	20400
Business Graphic Winmark	432	440
Hi-end Graphic Winmark	1250	1270
SYS Mark 2001 : SISMark 2000/2001 Rating (Internet Content Creation / Office Productivity)		
SISMark 2000	205 (223/192)	214 (233/201)
SISMark 2001	149 (167/133)	154 (174/136)
SISOFT Sandra 2001 :		
Dhrystone ALU MIPS	3623	3616
Whetstone FPU MFLOPS	1136/2365	1131/2369
Int ALU/RAM MB/S	881	1098
Float FPU/RAM MB/S	892	1117
Integer SSE2 IT/S	7531	7538
Floating-Point SSE2 IT/S	9342	9333
QUAKE3 DEMO1 FPS	164.6	176.6
DEMO2 FPS	164.9	178.7
WCPUID System/CPU Clock	100.67/1912.81	100.67/1912.81



1-4 Layout Diagram & Jumper Setting

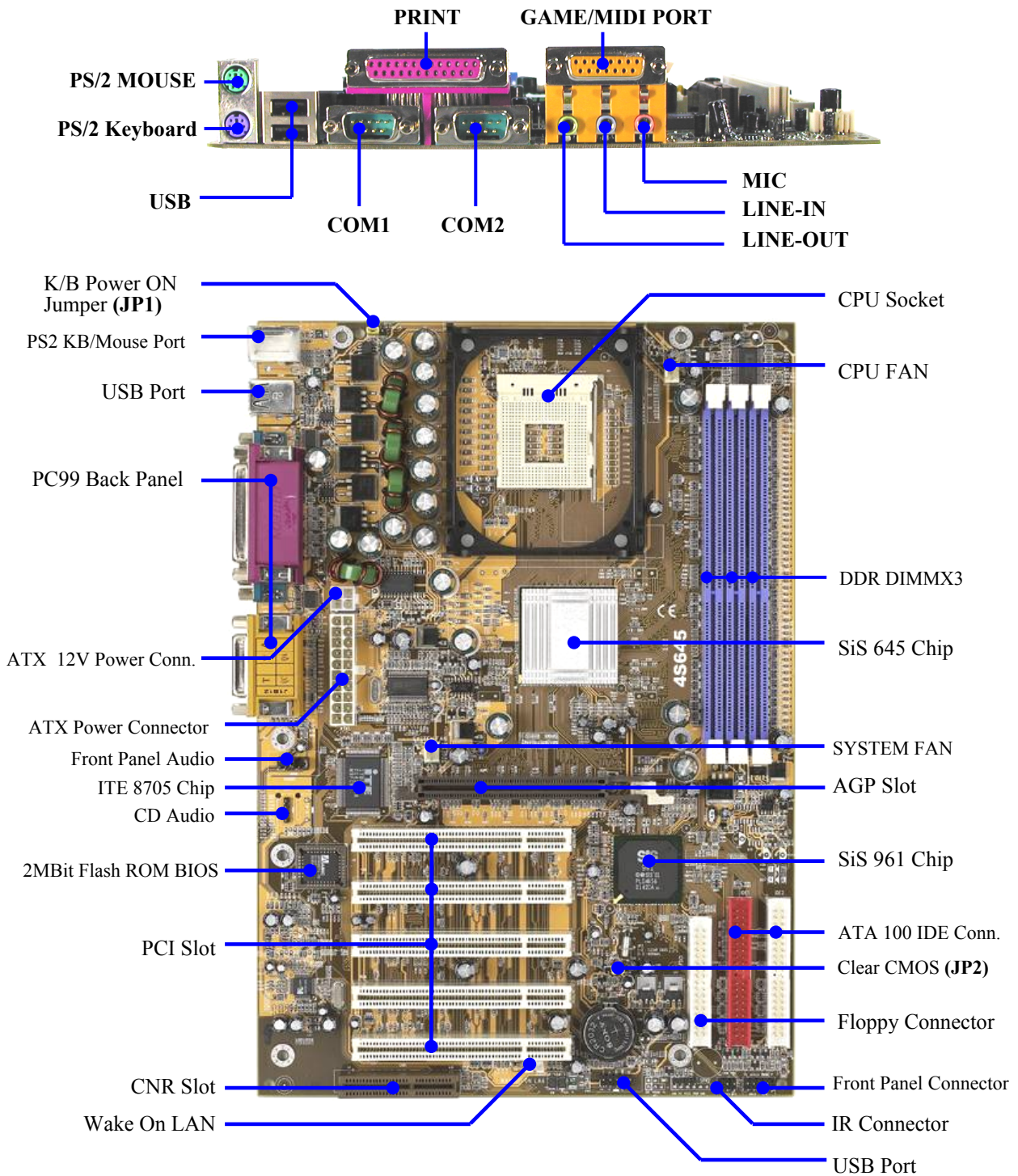

Jumpers

Jumper	Name	Description	Page
JP2	CMOS RAM Clear	3-pin Block	P.7
JP1	Keyboard Power On Enable/Disabled	3-pin Block	P.8

Connectors

Connector	Name	Description	Page
ATX1	ATX Power Connector	20-pin Block	P.12
ATX2	ATX 12V Power Connector	4-pin Block	P.13
KBMS1	PS/2 Mouse & PS/2 Keyboard Connector	6-pin Female	P.13
USB1	USB Port Connector	4-pin Connector	P.13
PRINT1	Parallel Port Connector	25-pin Female	P.13
AUDI_GAME	Audio/Game Connector	3 phone jack + 15-pin Connector	P.13
COM1/COM2	Serial Port COM1/2 Connector	9-pin Connector	P.14
FDC1	Floppy Driver Connector	34-pin Block	P.14
IDE1/IDE2	Primary/Secondary IDE Connector	40-pin Block	P.14

Headers

Header	Name	Description	Page
FAUDIO	SPEAKER, MIC header	9-pin Block	P.15
USB2	USB Port Headers	9-pin Block	P.16
HDLED	IDE activity LED	2-pin Block	P.16
RESET	Reset switch lead	2-pin Block	P.16
SPK2	PC Speaker connector	4-pin Block	P.16
ACPILED	Power LED	2-pin Block	P.16
PWRBT	Power switch	2-pin Block	P.16
WOL1	Wake On-LAN Headers	3-pin Block	P.17
SYSTEM FAN, CPU FAN	FAN Speed Headers	3-pin Block	P.17
IR1	IR infrared module Headers	5-pin Block	P.17
CDIN1	CD Audio-In Headers	4-pin Block	P.18

Expansion Sockets

Socket/Slot	Name	Description	Page
ZIF Socket 478	CPU Socket	478-pin mPGAB CPU Socket	P.9
DIMM1, DIMM2, DIMM3	SDRAM Module Socket	184-pin DDR SDRAM Module Expansion Socket	P.10
PCI1 ~ PCI5	PCI Slot	32-bit PCI Local Bus Expansion slots	P.11
AGP	AGP 4X Mode Slot	AGP Expansion Slot	P.12
CNR	CNR Slot	Communication Network Riser Slot	

Chapter 2

Hardware installation

2-1 Hardware installation Steps

Before using your computer, you had better complete the following steps:

1. Check motherboard jumper setting
2. Install CPU and Fan
3. Install System Memory (DIMM)
4. Install Expansion cards
5. Connect IDE and Floppy cables, Front Panel /Back Panel cable
6. Connect ATX Power cable
7. Power-On and Load Standard Default
8. Reboot
9. Install Operating System
10. Install Driver and Utility

2-2 Checking Motherboard's Jumper Setting

(1) CMOS RAM Clear (3-pin) : JP2

A battery must be used to retain the motherboard configuration in CMOS RAM short 2-3 pins of JP2 to store the CMOS data.

To clear the CMOS, follow the procedure below:

1. Turn off the system and unplug the AC power
2. Remove ATX power cable from ATX power connector
3. Locate JP2 and short pins 1-2 for a few seconds
4. Return JP2 to its normal setting by shorting pins 2-3
5. Connect ATX power cable back to ATX power connector

Note: When should clear CMOS

1. **Troubleshooting**
2. **Forget password**
3. **After over clocking system boot fail**

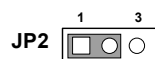
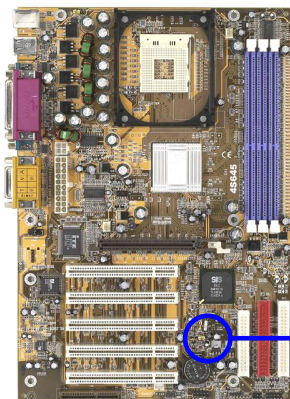

1-2 closed Clear CMOS

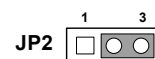

2-3 closed Normal (Default)

CMOS RAM Clear Setting

(2) Keyboard Power On function Enabled/Disabled: JP1

When setting Enabled you can use keyboard by key in password to power on system.

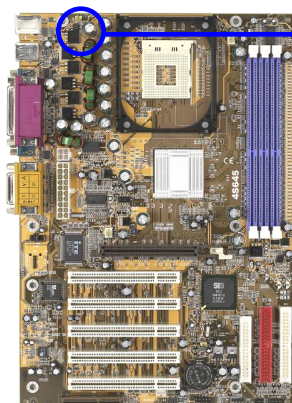

Keyboard Power On Setting

2-3 Install CPU

2-3-1 Glossary

Chipset (or core logic) - two or more integrated circuits which control the interfaces between the system processor, RAM, I/O devices, and adapter cards.

Processor slot/socket - the slot or socket used to mount the system processor on the motherboard.

Slot (AGP, PCI, ISA, RAM) - the slots used to mount adapter cards and system RAM.

AGP - Accelerated Graphics Port - a high speed interface for video cards; runs at 1X (66MHz), 2X (133MHz), or 4X (266MHz).

PCI - Peripheral Component Interconnect - a high speed interface for video cards, sound cards, network interface cards, and modems; runs at 33MHz.

ISA - Industry Standard Architecture - a relatively low speed interface primarily used for sound cards and modems; runs at approx. 8MHz.

Serial Port - a low speed interface typically used for mouse and external modems.

Parallel Port - a low speed interface typically used for printers.

PS/2 - a low speed interface used for mouse and keyboards.

USB - Universal Serial Bus - a medium speed interface typically used for mouse, keyboards, scanners, scanners, and some digital cameras.

Sound (interface) - the interface between the sound card or integrated sound connectors and speakers, MIC, game controllers, and MIDI sound devices.

LAN (interface) - **Local Area Network** - the interface to your local area network.

BIOS (Basic Input/Output System) - the program logic used to boot up a computer and establish the relationship between the various components.

Driver - software, which defines the characteristics of a device for use by another device or other software.

Processor - the "central processing unit" (CPU); the principal integrated circuit used for doing the "computing" in "personal computer"

Front Side Bus Frequency - the working frequency of the motherboard, which is generated by the clock generator for CPU, DRAM and PCI BUS.

CPU L2 Cache - the flash memory inside the CPU, normal it depend on CPU type

2-3-2 About Intel Pentium 4 478-pin CPU

This motherboard provides a 478-pin surface mount, Zero Insertion Force (ZIF) socket, referred to as the mPGA478B socket supports Intel Pentium 4 processor in the 478 Pin package utilizes Flip-Chip Pin Grid Array (FC-PGA2) package technology.

The CPU that comes with the motherboard should have a cooling FAN attached to prevent overheating. If this is not the case, then purchase a correct cooling FAN before you turn on your system.

WARNING! Be sure that there is sufficient air circulation across the processor's heatsink and CPU cooling FAN is working correctly, otherwise it may cause the processor and motherboard overheat and damage, you may install an auxiliary cooling FAN, if necessary.

To install a CPU, first turn off your system and remove its cover. Locate the ZIF socket and open it by first pulling the level sideways away from the socket then upward to a 90-degree angle. Insert the CPU with the correct orientation as shown below. The notched corner should point toward the end of the level. Because the CPU has a corner pin for two of the four corners, the CPU will only fit in the orientation as shown.

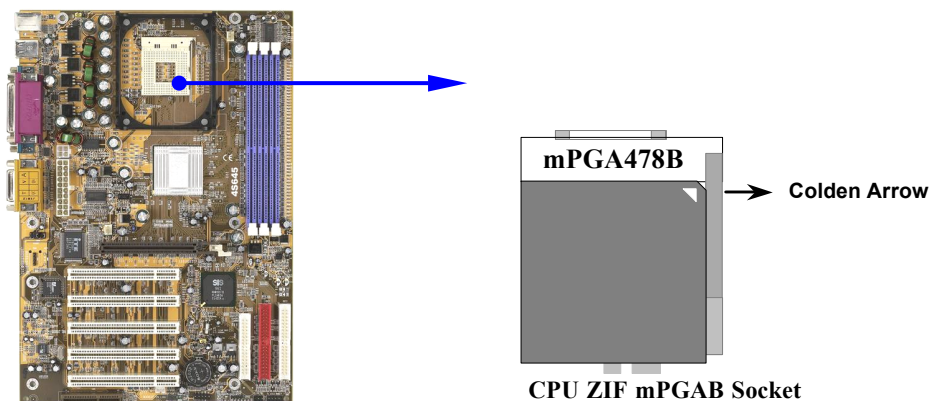

When you put the CPU into the ZIF socket. No force require to insert of the CPU, then press the level to Locate position slightly without any extra force.

2-4 Install Memory

This motherboard provides **three** 184-pin DUAL INLINE MEMORY MODULES (DIMM) sites for DDR memory expansion available from minimum memory size of 64MB to maximum memory size of 3.0GB DDR SDRAM.

Valid Memory Configurations

Bank	184-Pin DIMM		Total Memory
Bank 0, 1 (DIMM1)	DDR200/DDR266/ DDR333 DDR SDRAM Module	X1	64MB~1.0GB
Bank 2, 3 (DIMM2)	DDR200/DDR266/ DDR333 DDR SDRAM Module	X1	64MB~1.0GB
Bank 4, 5 (DIMM3)	DDR200/DDR266 DDR SDRAM Module	X1	64MB~1.0GB
Total	System Memory (Max. 3.0GB)	3	64MB~3.0GB

NOTE! Due to SiS 645 chip specification limited it only can support **2 pcs** DDR333 module when DDR clock setting in 166MHz.

Generally, installing DDR SDRAM modules to your motherboard is very easy, you can refer to figure 2-4 to see what a 184-Pin DDR SDRAM module looks like.

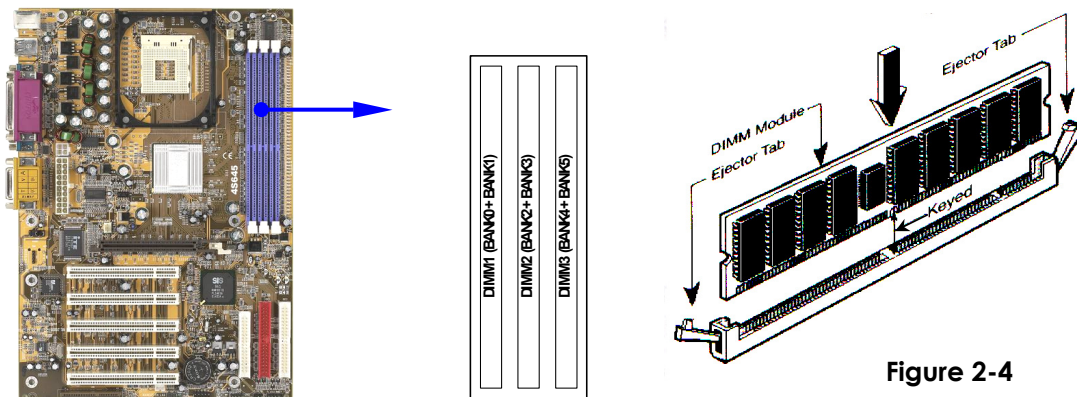

Figure 2-4

NOTE! When you install DIMM module fully into the DIMM socket the eject tab should be locked into the DIMM module very firmly and fit into its indentation on both sides.

WARNING! For the DDR SDRAM CLOCK is set at 133MHz, use only DDR266-compliant DDR Modules. When this motherboard operate at 133Mhz, most system will not even boot if non-compliant modules are used because of the strict timing issues, if your DDR Modules are not DDR266-compliant, set the SDRAM clock to 100MHz to ensure system stability.

2-5 Expansion Cards

WARNING! Turn off your power when adding or removing expansion cards or other system components. Failure to do so may cause severe damage to both your motherboard and expansion cards.

2-5-1 Procedure For Expansion Card Installation

1. Read the documentation for your expansion card and make any necessary hardware or software setting for your expansion card such as jumpers.
2. Remove your computer's cover and the bracket plate on the slot you intend to use.
3. Align the card's connectors and press firmly.
4. Secure the card on the slot with the screen you remove above.
5. Replace the computer system's cover.
6. Set up the BIOS if necessary.
7. Install the necessary software driver for your expansion card.

2-5-2 Assigning IRQs For Expansion Card

Some expansion cards need an IRQ to operate. Generally, an IRQ must exclusively assign to one use. In a standard design, there are 16 IRQs available but most of them are already in use.

Standard Interrupt Assignments

IRQ	Priority	Standard function
0	N/A	System Timer
1	N/A	Keyboard Controller
2	N/A	Programmable Interrupt
3 *	8	Communications Port (COM2)
4 *	9	Communications Port (COM1)
5 *	6	Sound Card (sometimes LPT2)
6 *	11	Floppy Disk Controller
7 *	7	Printer Port (LPT1)
8	N/A	System CMOS/Real Time Clock
9 *	10	ACPI Mode when enabled
10 *	3	IRQ Holder for PCI Steering
11 *	2	IRQ Holder for PCI Steering
12 *	4	PS/2 Compatible Mouse Port
13	N/A	Numeric Data Processor
14 *	5	Primary IDE Channel
15 *	1	Secondary IDE Channel

* These IRQs are usually available for ISA or PCI devices.

2-5-3 Interrupt Request Table For This Motherboard

Interrupt request are shared as shown the table below:

	INT A	INT B	INT C	INT D	INT E	INT F	INT G	INT H
Slot 1	√							
Slot 2		√						
Slot 3			√					
Slot 4				√				
Slot 5								
Onboard USB 1					√			
Onboard USB 2								√
AC97/MC97			√					
PROMISE				√				

IMPORTANT! If using PCI cards on shared slots, make sure that the drivers support “Shared IRQ” or that the cards don’t need IRQ assignments. Conflicts will arise between the two PCI groups that will make the system unstable or cards inoperable.

2-5-4 AGP Slot

This motherboard provides an AGP Slot, support the 1X/2X/4X AGP VGA card.

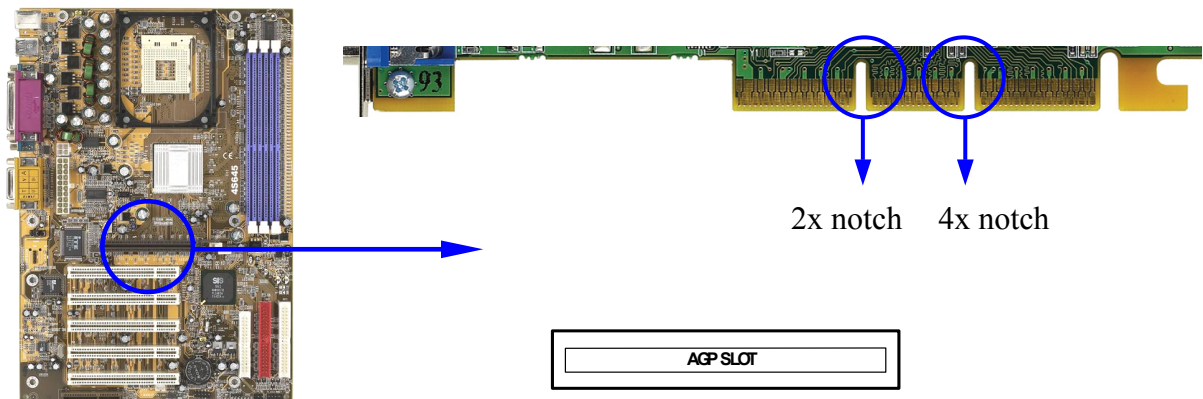

2-6 Connectors, Headers

2-6-1 Connectors

(1) Power Connector (20-pin block) : ATX1

ATX Power Supply connector. This is a new defined 20-pins connector that usually comes with ATX case. The ATX Power Supply allows to use soft power on momentary switch that connect from the front panel switch to 2-pins Power On jumper pole on the motherboard. When the power switch on the back of the ATX power supply turned on, the full power will not come into the system board until the front panel switch is momentarily pressed. Press this switch again will turn off the power to the system board.

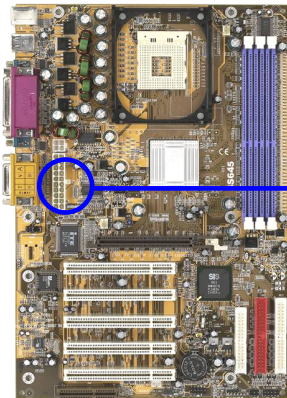

PIN	ROW2	ROW1
1	3.3V	3.3V
2	-12V	3.3V
3	GND	GND
4	Soft Power On	5V
5	GND	GND
6	GND	5V
7	GND	GND
8	-5V	Power OK
9	+5V	+5V (for Soft Logic)
10	+5V	+12V

(2) ATX 12V Power Connector (4-pin block) : ATX2

This is a new defined 4-pin connector that usually comes with ATX Power Supply. The ATX Power Supply which fully support Pentium 4 processor must including this connector for support extra 12V voltage to maintain system power consumption. Without this connector might cause system unstable because the power supply can not provide sufficient current for system.

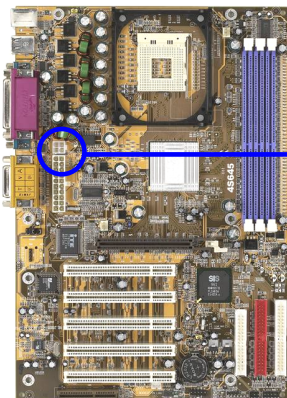

* This Motherboard Conditional supports the ATX Power Supply which without Extra ATX 12V Power connector, if it's 12V output can offer more than 120W to maintain system power consumption.

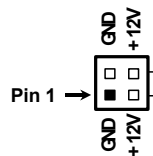

(3) PS/2 Mouse & PS/2 Keyboard Connector: KBMS1

The connectors for PS/2 keyboard and PS/2 Mouse.

(4) USB Port connector: USB1

The connectors are 4-pin connector that connect USB devices to the system board.

(5) Parallel Port Connector (25-pin female): PRINT1

Parallel Port connector is a 25-pin D-Subminiature Receptacle connector. The On-board Parallel Port can be disabled through the BIOS SETUP. Please refer to Chapter 3 "INTEGRATED PERIPHERALS SETUP" section for more detail information.

(6) Audio and Game Connector : AUDIO_GAME (SPK1, LININ1, MIC1, GAME1)

This Connector are 3 phone Jack for LINE-OUT, LINE-IN, MIC and a 15-pin D-Subminiature Receptacle Connector for joystick/MIDI Device.

- Line-out :** Audio output to speaker
- Line-in :** Audio input to sound chip
- MIC :** Microphone Connector
- Game/MIDI :** For joystick or MIDI Device

(7) **Serial Port COM1, COM2 : COM1, COM2**

COM1, COM2 are the 9-pin D-Subminiature mail connector. The On-board serial port can be disabled through BIOS SETUP. Please refer to Chapter 3 “INTEGRATED PERIPHERALS SETUP” section for more detail information.

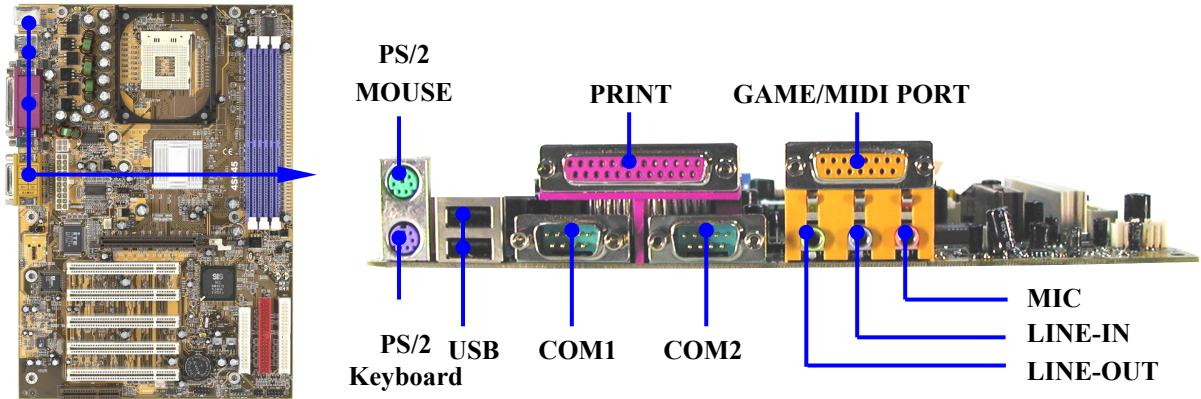

(8) **Floppy drive Connector (34-pin block): FDC1**

This connector supports the provided floppy drive ribbon cable. After connecting the single plug end to motherboard, connect the two plugs at other end to the floppy drives.

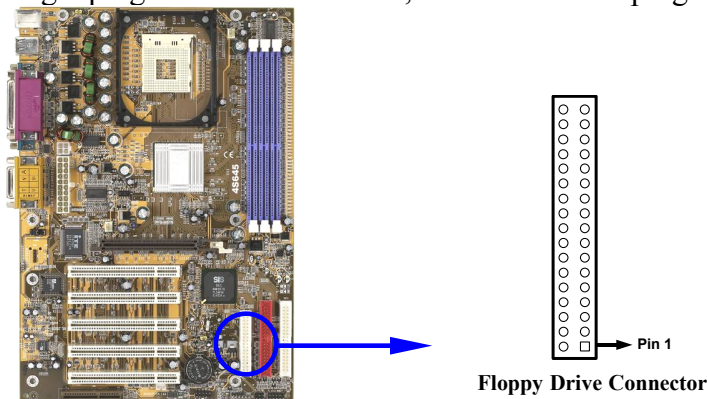

(9) **Primary IDE Connector (40-pin block): IDE1**

This connector supports the provided IDE hard disk ribbon cable. After connecting the single plug end to motherboard, connect the two plugs at other end to your hard disk(s). If you install two hard disks, you must configure the second drive to Slave mode by setting its jumpers accordingly. Please refer to the documentation of your hard disk for the jumper settings.

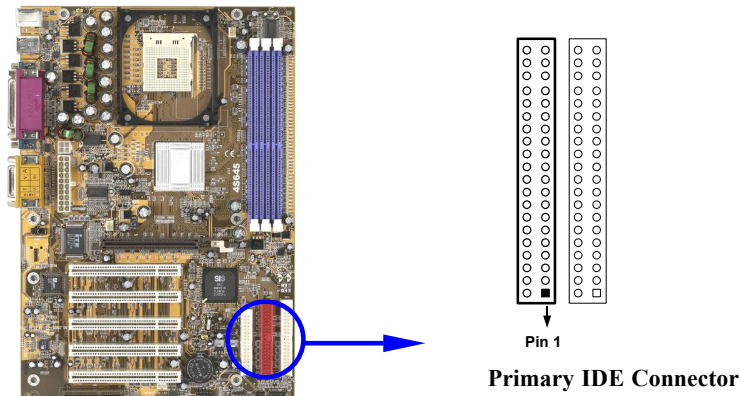

(10) Secondary IDE Connector (40-pin block): IDE2

This connector connects to the next set of Master and Slave hard disks. Follow the same procedure described for the primary IDE connector. You may also configure two hard disks to be both Masters using one ribbon cable on the primary IDE connector and another ribbon cable on the secondary IDE connector.

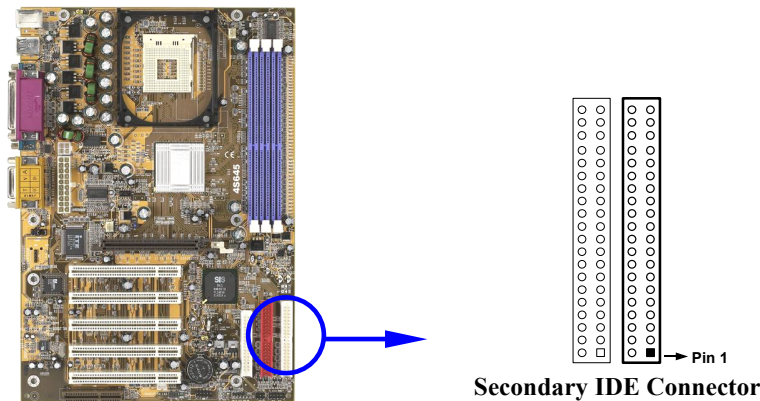

- Two hard disks can be connected to each connector. The first HDD is referred to as the “Master” and the second HDD is referred to as the “Slave”.
- For performance issues, we strongly suggest you don’t install a CD-ROM or DVD-ROM drive on the same IDE channel as a hard disk. Otherwise, the system performance on this channel may drop.

2-6-2 Headers

(1) Line-Out/MIC Header for Front Panel (9-pin): FAUDIO

This header connect to Front Panel Line-out, MIC connector with cable.

Without install the cable, this header default setting is 5-6 short, 9-10 short. When you install the cable you have take off these jumpers.

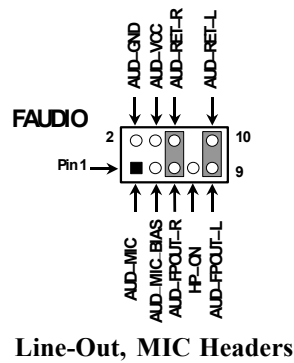
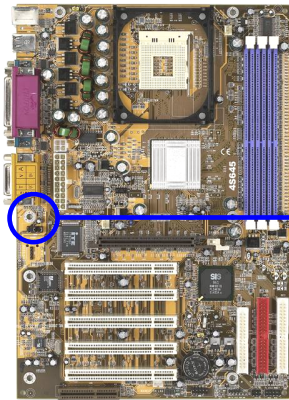

(2) USB Port Headers (9-pin) : USB2

These headers are used for connecting the additional USB port plug. By attaching an option USB cable, your can be provided with two additional USB plugs affixed to the back panel.

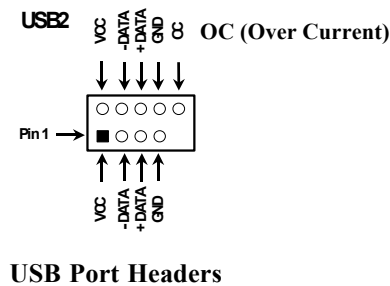
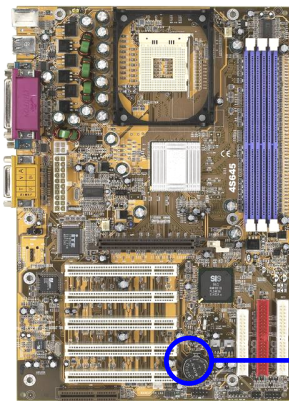

(3) IDE Activity LED: HDLED

This connector connects to the hard disk activity indicator light on the case.

(4) Reset switch lead: RESET

This 2-pin connector connects to the case-mounted reset switch for rebooting your computer without having to turn off your power switch. This is a preferred method of rebooting in order to prolong the life of the system's power supply. See the figure below.

(5) Speaker connector: SPK2

This 4-pin connector connects to the case-mounted speaker. See the figure below.

(6) Power LED: ACPILED

The Power LED is light on while the system power is on. Connect the Power LED from the system case to this pin.

(7) Power switch: PWRBT

This 2-pin connector connects to the case-mounted power switch to power ON/OFF the system.

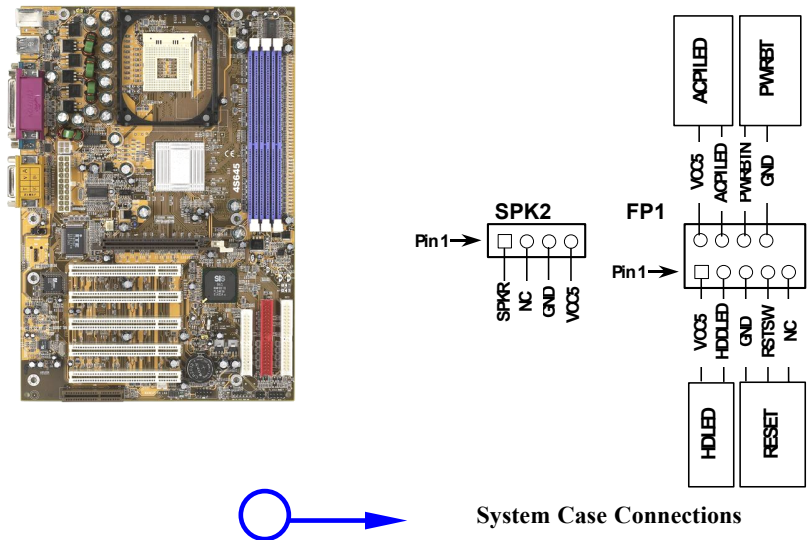

(8) Wake On-LAN Headers (3-pin) : WOL1

This connector connects to a LAN card with a WAKE ON-LAN output. This connector power up the system when a wake up signal is received through the LAN/Modem card.

NOTE: This feature requires that Wake On LAN or Ring In Wake up is enabled.

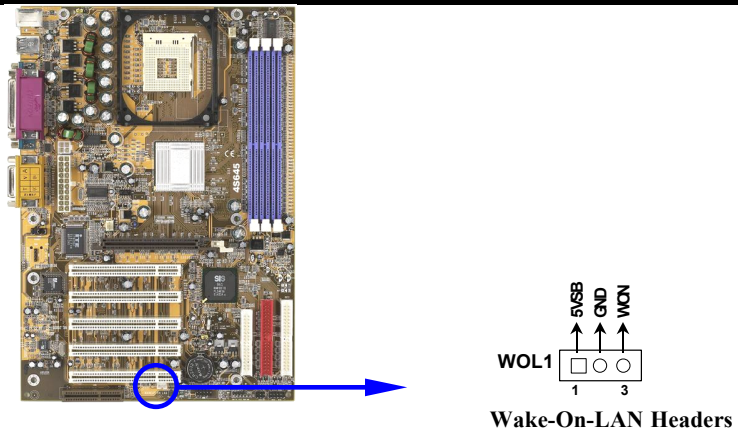

(9) FAN Speed Headers (3-pin) : SYSTEM FAN, CPU FAN

These connectors support cooling fans of 350mA (4.2 Watts) or less, depending on the fan manufacturer, the wire and plug may be different. The red wire should be positive, while the black should be ground. Connect the fan's plug to the board taking into consideration the polarity of connector.

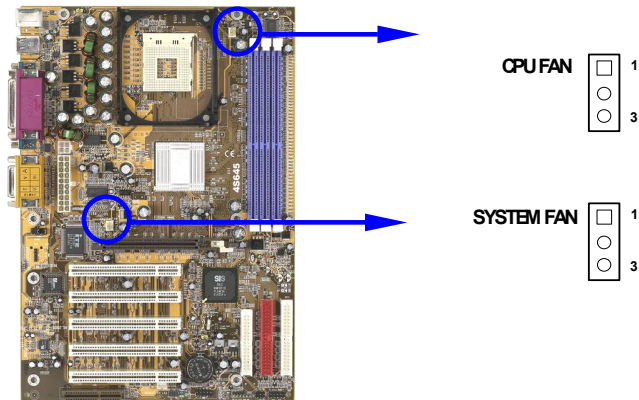

(10) IR infrared module Headers (5-pin) : IR1

This connector supports the optional wireless transmitting and receiving infrared module. You must configure the setting through the BIOS setup to use the IR function.

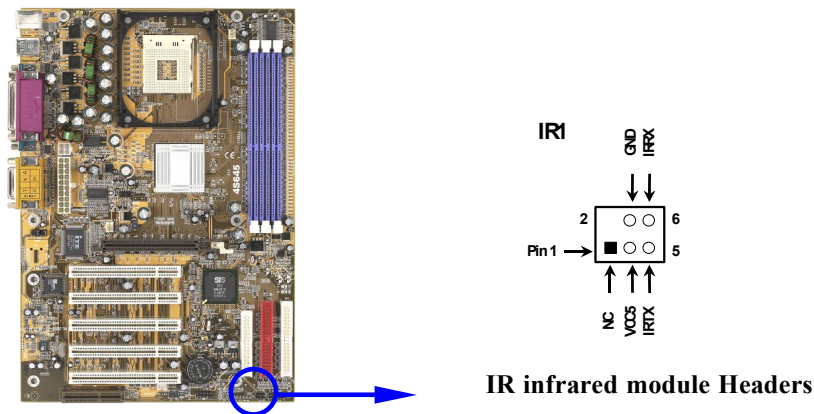

(11) CD Audio-In Headers (4-pin) : CDIN1

CDIN are the connectors for CD-Audio Input signal. Please connect it to CD-ROM CD-Audio output connector.

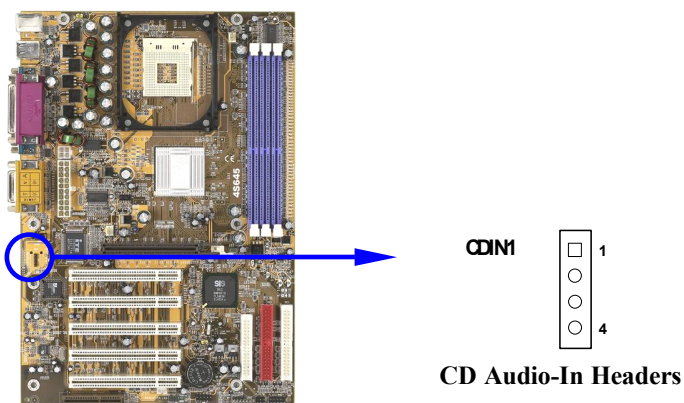

2-7 Starting Up Your Computer

1. After all connection are made, close your computer case cover.
2. Be sure all the switch are off, and check that the power supply input voltage is set to proper position, usually in-put voltage is 220V~240V or 110V~120V depending on your country's voltage used.
3. Connect the power supply cord into the power supply located on the back of your system case according to your system user's manual.
4. Turn on your peripheral as following order:
 - a. Your monitor.
 - b. Other external peripheral (Printer, Scanner, External Modem etc...)
 - c. Your system power. For ATX power supplies, you need to turn on the power supply and press the ATX power switch on the front side of the case.
5. The power LED on the front panel of the system case will light. The LED on the monitor may light up or switch between orange and green after the system is on. If it complies with green standards or if it is has a power standby feature. The system will then run power-on test. While the test are running, the BIOS will alarm beeps or additional message will appear on the screen.

If you do not see any thing within 30 seconds from the time you turn on the power. The system may have failed on power-on test. Recheck your jumper settings and connections or call your retailer for assistance.

Beep	Meaning
One short beep when displaying logo	No error during POST
Long beeps in an endless loop	No DRAM install or detected
One long beep followed by three short beeps	Video card not found or video card memory bad
High frequency beeps when system is working	CPU overheated System running at a lower frequency

6. During power-on, press <Delete> key to enter BIOS setup. Follow the instructions in BIOS SETUP.
7. **Power off your computer:** You must first exit or shut down your operating system before switch off the power switch. For ATX power supply, you can press ATX power switching after exiting or shutting down your operating system. If you use Windows 9X, click "Start" button, click "Shut down" and then click "Shut down the computer?" The power supply should turn off after windows shut down.

Chapter 3

Introducing BIOS

The BIOS is a program located on a Flash Memory on the motherboard. This program is a bridge between motherboard and operating system. When you start the computer, the BIOS program gain control. The BIOS first operates an auto-diagnostic test called POST (power on self test) for all the necessary hardware, it detects the entire hardware device and configures the parameters of the hardware synchronization. Only when these tasks are completed done it gives up control of the computer to operating system (OS). Since the BIOS is the only channel for hardware and software to communicate, it is the key factor for system stability, and in ensuring that your system performance as its best.

In the BIOS Setup main menu of Figure 3-1, you can see several options. We will explain these options step by step in the following pages of this chapter, but let us first see a short description of the function keys you may use here:

- Press <Esc> to quit the BIOS Setup.
- Press ↑↓←→ (up, down, left, right) to choose, in the main menu, the option you want to confirm or to modify.
- Press <F10> when you have completed the setup of BIOS parameters to save these parameters and to exit the BIOS Setup menu.
- Press Page Up/Page Down or +/- keys when you want to modify the BIOS parameters for the active option.

3-1 Entering Setup

Power on the computer and by pressing immediately allows you to enter Setup. If the message disappears before your respond and you still wish to enter Setup, restart the system to try again by turning it OFF then ON or pressing the “RESET” button on the system case. You may also restart by simultaneously pressing <Ctrl>, <Alt> and <Delete> keys. If you do not press the keys at the correct time and the system does not boot, an error message will be displayed and you will again be asked to

Press <F1> to continue, <Ctrl-Alt-Esc> or to enter Setup

3-2 Getting Help

Main Menu

The on-line description of the highlighted setup function is displayed at the bottom of the screen.

Status Page Setup Menu/Option Page Setup Menu

Press F1 to pop up a small help window that describes the appropriate keys to use and the possible selections for the highlighted item. To exit the Help Window, press <Esc>.

3-3 The Main Menu

Once you enter Award® BIOS CMOS Setup Utility, the Main Menu (Figure 3-1) will appear on the screen. The Main Menu allows you to select from fourteen setup functions and two exit choices. Use arrow keys to select among the items and press <Enter> to accept or enter the sub-menu.

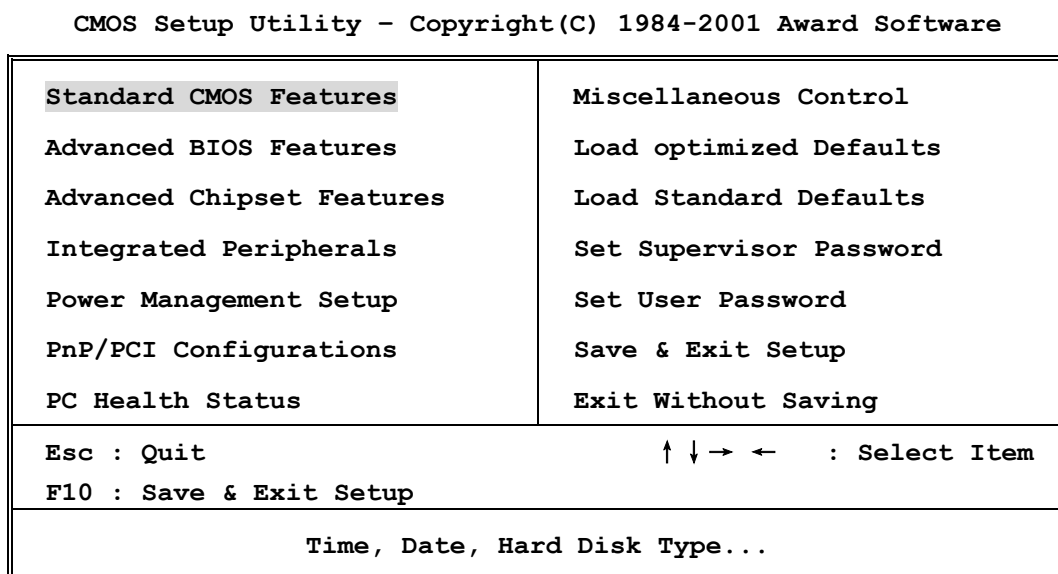

Figure 3-1

Standard CMOS Features

Use this Menu for basic system configurations.

Advanced BIOS Features

Use this menu to set the Advanced Features available on your system.

Advanced Chipset Features

Use this menu to change the values in the chipset registers and optimize your system's performance.

Integrated Peripherals

Use this menu to specify your settings for integrated peripherals.

Power Management Setup

Use this menu to specify your settings for power management.

PnP/PCI configurations

This entry appears if your system supports PnP/PCI.

PC Health Status

This entry shows your PC health status.

Miscellaneous Control

Use this menu to specify your settings for Miscellaneous control.

Load Optimized Defaults

Use this menu to load the BIOS default values that are factory settings for optimal performances system operations.

Load Standard Defaults

Use this menu to load the BIOS default values for the minimal/stable performance system operation.

Set Supervisor/User Password

Use this menu to set User and Supervisor Passwords.

Save & Exit Setup

Save CMOS value changes to CMOS and exit setup.

Exit Without Saving

Abandon all CMOS value changes and exit setup.

3-4 Standard CMOS Features

The items in Standard CMOS Setup Menu are divided into several categories. Each category includes no, one or more than one setup items. Use the arrow keys to highlight the item and then use the <PgUp> or <PgDn> keys to select the value you want in each item.

CMOS Setup Utility - Copyright(C) 1984-2001 Award Software
Standard CMOS Features

Date (mm:dd:yy) Mon, Oct, 26 2001 Time (hh:mm:ss) 16 : 48 : 35 > IDE Primary Master Press Enter None > IDE Primary Slave Press Enter None > IDE Secondary Master Press Enter None > IDE Secondary Slave Press Enter None Drive A 1.44M, 3.25 in. Drive B None Video EGA/VGA Halt On All,But Keyboard Base Memory 640K Extended Memory 56320K Total Memory 57344K	<table border="1" style="width: 100%; border-collapse: collapse;"> <tr> <td style="width: 80%; text-align: center;">Item Help</td> </tr> <tr> <td style="padding: 5px;"> Menu Level > Change the day, month, year and century </td> </tr> </table>	Item Help	Menu Level > Change the day, month, year and century
Item Help			
Menu Level > Change the day, month, year and century			
↑ ↓ → ← Move Enter:Select +/-/PU/PD:Value F10:Save ESC:Exit F1:General Help F5:Previous Values F6:Optimized Defaults F7:Standard Defaults			

Date

The date format is <day><month><date><year>.

- Day** Day of the week, from Sun to Sat, determined by BIOS. Read-only.
- Month** The month from Jan. through Dec.
- Date** The date from 1 to 31 can be keyed by numeric function keys.
- Year** The year depends on the year of the BIOS.

Time

The time format is <hour><minute><second>.

**Primary Master/Primary Slave
Secondary Master/Secondary Slave**

Press PgUp/<+> or PgDn/<-> to select Manual, None, Auto type. Note that the specifications of your drive must match with the drive table. The hard disk will not work properly if you enter improper information for this category. If your hard disk drive type is not matched or listed, you can use Manual to define your own drive type manually.

If you select Manual, related information is asked to be entered to the following items. Enter the information directly from the keyboard. This information should be provided in the documentation from your hard disk vendor or the system manufacturer. If the controller of HDD interface is SCSI, the selection shall be "None".

If the controller of HDD interface is CD-ROM, the selection shall be "None"

- Access Mode** The settings are Auto Normal, Large, and LBA.
- Cylinder** number of cylinders
- Head** number of heads
- Precomp** write precomp
- Landing Zone** landing zone
- Sector** number of sectors

3-5 Advanced BIOS Features

CMOS Setup Utility - Copyright(C) 1984-2001 Award Software
Advanced BIOS Features

Anti-Virus Protection	Disabled	Item Help	
CPU L1 & L2 Cache	Enabled		
CPU L2 Cache ECC Checking	Disabled	Menu Level > Allows you to choose the VIRUS warning feature for IDE Hard Disk boot sector protection. If this function is enabled and someone attempt to write data into this area, BIOS will show a warning message on screen and alarm beep Enabled copies Video BIOS to shadow RAM Improves performance	
Quick Power On Self Test	Enabled		
First Boot Device	Floppy		
Second Boot Device	HDD-0		
Third Boot Device	CDROM		
Boot Other Device	Enabled		
Swap Floppy Drive	Disabled		
Boot Up Floppy Seek	Enabled		
Boot Up NumLock Status	On		
Gate A20 Option	Fast		
Typematic Rate Setting	Disabled		
Typematic Rate (Chars/Sec)	6		
Typematic Delay (Msec)	250		
Security Option	Setup		
OS Select For DRAM > 64MB	Non-OS2		
HDD S.M.A.R.T. Capability	Disabled		
Report No FDD For Windows	Yes		
Video BIOS Shadow	Enabled		
↑ ↓ → ← Move Enter:Select +/-/PU/PD:Value F10:Save ESC:Exit F1:General Help F5:Previous Values F6:Optimized Defaults F7:Standard Defaults			

Anti-Virus Protection

Allows you to choose the VIRUS Warning feature for IDE Hard Disk boot sector protection. If this function is enabled and someone attempt to write data into this area, BIOS will show a warning message on screen and alarm beep.

Disabled (default) No warning message to appear when anything attempts to access the boot sector or hard disk partition table.

Enabled Activates automatically when the system boots up causing a warning message to appear when anything attempts to access the boot sector of hard disk partition table.

CPU L1 Cache

The default value is Enabled.

Enabled (default) Enable cache

Disabled Disable cache

Note: The internal cache is built in the processor.

CPU L2 Cache

Choose Enabled or Disabled. This option enables the Level 2 cache memory.

Quick Power On Self Test

This category speeds up Power On Self Test (POST) after you power on the computer. If this is set to Enabled. BIOS will shorten or skip some check items during POST.

Enabled (default) Enable quick POST

Disabled Normal POST

First/Second/Third/ Boot Device, Boot Other Device

The BIOS attempts to load the operating system from the devices in the sequence selected in these items. The settings are Floppy, LS/ZIP, HDD-0/HDD-1/HDD-3, SCSI, CDROM, LAN and Disabled.

Swap Floppy Drive

Switches the floppy disk drives between being designated as A and B. Default is Disabled.

Boot Up Floppy Seek

During POST, BIOS will determine if the floppy disk drive installed is 40 or 80 tracks. 360K type is 40 tracks while 760K, 1.2M and 1.44M are all 80 tracks.

Boot Up NumLock Status

The default value is On.

On (default) Keypad is numeric keys.

Off Keypad is arrow keys.

Gate A20 Option

Normal The A20 signal is controlled by keyboard controller or chipset hardware.

Fast (default) The A20 signal is controlled by port 92 or chipset specific method.

Typematic Rate Setting

Keystrokes repeat at a rate determined by the keyboard controller. When enabled, the typematic rate and typematic delay can be selected. The settings are: Enabled/Disabled.

Typematic Rate (Chars/Sec)

Sets the number of times a second to repeat a keystroke when you hold the key down. The settings are: 6, 8, 10, 12, 15, 20, 24, and 30.

Typematic Delay (Msec)

Sets the delay time after the key is held down before it begins to repeat the keystroke. The settings are 250, 500, 750, and 1000.

Security Option

This category allows you to limit access to the system and Setup, or just to Setup.

System The system will not boot and access to Setup will be denied if the correct password is not entered at the prompt.

Setup (default) The system will boot, but access to Setup will be denied if the correct password is not entered prompt.

OS Select For DRAM > 64MB

Allows OS2[®] to be used with >64MB or DRAM. Settings are Non-OS/2 (default) and OS2. Set to OS/2 if using more than 64MB and running OS/2[®].

Report No FDD For Win 95

Whether report no FDD for Win 95 or not. The settings are: Yes, No.

3-6 Advanced Chipset Features

The Advanced Chipset Features Setup option is used to change the values of the chipset registers. These registers control most of the system options in the computer.

CMOS Setup Utility - Copyright(C) 1984-2001 Award Software
Advanced Chipset Features

> DRAM Timing Settings	Press Enter	Item Help
> AGP Function Settings	Press Enter	
Prefetch Caching	Disabled	
Memory Hole at 15M-16M	Disabled	Menu Level >
↑ ↓ → ← Move Enter:Select +/-/PU/PD:Value F10:Save ESC:Exit F1:General Help F5:Previous Values F6:Optimized Defaults F7:Standard Defaults		

DRAM Timing Settings

Please refer to section 3-6-1

AGP Function Settings

This option determines the effective size of the graphics aperture used in the particular PAC configuration. The AGP aperture is memory-mapped, while graphics data structure can reside in a graphics aperture. The aperture range should be programmed as not cacheable in the processor cache, accesses with the aperture range are forwarded to the main memory, then PAC will translate the original issued address via a translation table that is maintained on the main memory. The option allows the selection of an aperture size of 32MB, 64MB.

Please refer to section 3-6-2

Memory Hole at 15M-16M

You can reserve this area of system memory for ISA adapter ROM. When this area is reserved, it cannot be cached. The user information of peripherals that need to use this area of system memory usually discusses their memory requirements. The settings are: Enabled and Disabled.

3-6-1 DRAM Timing Setting

CMOS Setup Utility - Copyright(C) 1984-2001 Award Software

DRAM Timing Setting

Auto Configuration	Standard	Item Help
RAS Active Time	7T	
RAS Precharge Time	2T	
RAS to CAS Delay	2T	Menu Level >>
Write Recovery Time	2T	
CAS Latency Setting	2.5T	

↑ ↓ → ← Move Enter:Select +/-/PU/PD:Value F10:Save ESC:Exit F1:General Help
F5:Previous Values F6:Optimized Defaults F7:Standard Defaults

RAS Active Time

Select the number of SCLKs for an access cycle. The settings are: Auto (Default), 6T, 7T, 5T, 4T.

RAS Precharge Time

If an insufficient number of cycles is allowed for the RAS to accumulate its charge before DRAM refresh, the refresh may be incomplete and the DRAM may fail to retain data. *Fast* gives faster performance; and *Slow* gives more stable performance. This field applies only when synchronous DRAM is installed in the system. The settings are: Auto (default), 4T, 2T and 3T.

RAS to CAS Delay

This field let's you insert a timing delay between the CAS and RAS strobe signals, used when DRAM is written to, read from, or refreshed. *Fast* gives faster performance; and *Slow* gives more stable performance. This field applies only when synchronous DRAM is installed in the system. The settings are: 2T and 3T.

CAS Latency Setting

When synchronous DRAM is installed, the number of clock cycles of CAS latency depends on the DRAM timing. The settings are: Auto (Default) 2T and 3T.

3-6-2 AGP Function Settings

CMOS Setup Utility - Copyright(C) 1984-2001 Award Software
AGP Function Settings

AGP Transfer Mode	Auto	Item Help
AGP Fast Write	Disabled	
AGP Aperture Size	64MB	Menu Level >>
AGP Aperture Write Combining	Enabled	
AGP Driving Control	Auto	
AGP Driving Value	88	
↑ ↓ → ← Move Enter:Select +/-/PU/PD:Value F10:Save ESC:Exit F1:General Help F5:Previous Values F6:Optimized Defaults F7:Standard Defaults		

3-7 Integrated Peripherals

CMOS Setup Utility - Copyright(C) 1984-2001 Award Software
Integrated Peripherals

> OnChip IDE Function	Press Enter	Item Help
> OnChip Device Function	Press Enter	
> Onboard SuperIO Function	Press Enter	Menu Level >
Power Loss Function	Always Off	
Init Display First	PCI Slot	
↑ ↓ → ← Move Enter:Select +/-/PU/PD:Value F10:Save ESC:Exit F1:General Help F5:Previous Values F6:Optimized Defaults F7:Standard Defaults		

OnChip IDE Function

Please refer to section 3-7-1

OnChip Device Function

Please refer to section 3-7-2

Onboard SuperIO Function

Please refer to section 3-7-3

Init Display First

This item allows you to decide to activate whether PCI Slot or AGP VGA first. The settings are: PCI Slot, AGP Slot.

3-7-1 OnChip IDE Function

CMOS Setup Utility - Copyright(C) 1984-2001 Award Software
OnChip IDE Function

Internal PCI/IDE	Both	Item Help
Primary Master PIO	Auto	Menu Level >>
Primary Slave PIO	Auto	
Secondary Master PIO	Auto	
Secondary Slave PIO	Auto	
Primary Master UltraDMA	Auto	
Primary Slave UltraDMA	Auto	
Secondary Master UltraDMA	Auto	
Secondary Slave UltraDMA	Auto	
IDE Burst Mode	Enabled	
IDE HDD Block Mode	Enabled	
Delay For HDD (Secs)	0	
↑ ↓ → ← Move Enter:Select +/-/PU/PD:Value F10:Save ESC:Exit F1:General Help		
F5:Previous Values F6:Optimized Defaults F7:Standard Defaults		

Internal PCI/IDE

The integrated peripheral controller contains an IDE interface with support for two IDE channels. Select Both to activate each channel separately. The settings are: Both, IDE0, IDE1.

Primary/Secondary Master/Slave PIO

The four IDE PIO (Programmed Input/Output) fields let you set a PIO mode (0-4) for each of the four IDE devices that the onboard IDE interface supports. Modes 0 through 4 provide successively increased performance. In Auto mode, the system automatically determines the best mode for each device. The settings are: Auto, Mode 0, Mode 1, Mode 2, Mode 3, Mode 4.

Primary/Secondary Master/Slave UltraDMA

Ultra DMA/33 implementation is possible only if your IDE hard drive supports it and the operating environment includes a DMA driver (Windows 95 OSR2 or a third-party IDE bus master driver). If your hard drive and your system software both support Ultra DMA/33 and Ultra DMA/66, select Auto to enable BIOS support. The settings are: Auto, Disabled.

IDE HDD Block Mode

Block mode is also called block transfer, multiple commands, or multiple sector read/write. If your IDE hard drive supports block mode (most new drives do), select Enabled for automatic detection of the optimal number of block read/writes per sector the drive can support. The settings are: Enabled, Disabled.

3-7-2 OnChip Device Function

CMOS Setup Utility - Copyright(C) 1984-2001 Award Software
OnChip Device Function

AC97 Audio Device	Enabled	Item Help
Game Port Address	201	
Midi Port Address	Disabled	
Midi Port IRQ	10	
AC97 Modem Device	Enabled	Menu Level >>
USB Controller	Enabled	
USB Keyboard Legacy Support	Disabled	
↑ ↓ → ← Move Enter:Select +/-/PU/PD:Value F10:Save ESC:Exit F1:General Help F5:Previous Values F6:Optimized Defaults F7:Standard Defaults		

AC97 Audio Device

This item allows you to decide to enable/disable the chipset family to support AC97 Audio. The settings are: Enabled, Disabled.

Game Port Address/Midi Port Address

This will determine which Address the Game Port/Midi Port will use.

AC97 Modem Device

This item allows you to decide to enable/disable the chipset family to support AC97 Modem. The settings are: Auto, Disabled.

USB Controller

Select *Enabled* if your system contains a Universal Serial Bus (USB) controller and you have a USB peripherals. The settings are: Enabled, Disabled.

USB Keyboard Legacy Support

Select *Enabled* if your system contains a Universal Serial Bus (USB) controller and you have a USB keyboard. The settings are: Enabled, Disabled.

3-7-3 Onboard SuperIO Function

CMOS Setup Utility - Copyright(C) 1984-2001 Award Software
Onboard SuperIO Function

Onboard FDD Controller	Enabled	Item Help
Onboard Serial Port 1	3F8/IRQ4	
Onboard Serial Port 2	2F8/IRQ3	Menu Level >>
UART2 Mode	Normal	
IR Duplex Mode	Half	
Onboard Parallel Port	378/IRQ7	
Parallel Port Mode	SPP	
ECP Mode Use DMA	3	
↑ ↓ → ← Move Enter:Select +/-/PU/PD:Value F10:Save ESC:Exit F1:General Help F5:Previous Values F6:Optimized Defaults F7:Standard Defaults		

Onboard FDD Controller

Select Enabled if your system has a floppy disk controller (FDD) installed on the system board and you wish to use it. If you install add-on FDC or the system has no floppy drive, select Disabled in this field. The settings are: Enabled and Disabled.

Onboard Serial Port 1/Port 2

Select an address and corresponding interrupt for the first and the second serial ports. The settings are: 3F8/IRQ4, 2E8/IRQ3, 3E8/IRQ4, 2F8/IRQ3, Disabled, Auto.

UART 2 Mode

This item allows you to determine which InfraRed(IR) function of the onboard I/O chip, this functions uses.

Onboard Parallel Port

There is a built-in parallel port on the on-board Super I/O chipset that Provides Standard, ECP, and EPP features. It has the following option:

Disabled

(3BCH/IRQ7)/ Line Printer port 0

(278H/IRQ5)/ Line Printer port 2

(378H/IRQ7) Line Printer port 1

Parallel Port Mode

SPP : Standard Parallel Port

EPP : Enhanced Parallel Port

ECP : Extended Capability Port

SPP/EPP/ECP/ECP+EPP

To operate the onboard parallel port as Standard Parallel Port only, choose "SPP." To operate the onboard parallel port in the EPP modes simultaneously, choose "EPP." By choosing "ECP", the onboard parallel port will operate in ECP mode only. Choosing "ECP+EPP" will allow the onboard parallel port to support both the ECP and EPP modes simultaneously. The ECP mode has to use the DMA channel, so choose the onboard parallel port with the ECP feature. After selecting it, the following message will appear: "ECP Mode Use DMA" at this time, the user can choose between DMA channels 3 to 1. The onboard parallel port is EPP Spec. compliant, so after the user chooses the onboard parallel port with the EPP function, the following message will be displayed on the screen: "EPP Mode Select." At this time either EPP 1.7 spec. or EPP 1.9 spec. can be chosen.

3-8 Power Management Setup

The Power Management Setup allows you to configure your system to most effectively save energy saving while operating in a manner consistent with your own style of computer use.

CMOS Setup Utility - Copyright(C) 1984-2001 Award Software

Power Management Setup

ACPI Function	Enabled	Item Help
ACPI Suspend Type	S1 (POS)	
Video Off Option	Always Off	
Video Off Method	V/H SYNC+Blank	Menu Level >
MODEM Use IRQ	Auto	
Hot key Function as	Power Off	
Power Button Function	Instant Off	
> PM Wake Up Events	Press Enter	
↑ ↓ → ← Move Enter:Select +/-/PU/PD:Value F10:Save ESC:Exit F1:General Help F5:Previous Values F6:Optimized Defaults F7:Standard Defaults		

ACPI Function

This item allows you to Enabled/Disabled the Advanced Configuration and Power Management (ACPI). The settings are Enabled and Disabled.

Video Off Option

This determines the manner in which the monitor is blanked. The choice are Suspend → off, All Modes → Off, and Always On.

Video Off Method

This determines the manner in which the monitor is blanked.

- DPMS (default)** Initial display power management signaling.
- Blank Screen** This option only writes blanks to the video buffer.
- V/H SYNC+Blank** This selection will cause the system to turn off the vertical and horizontal synchronization ports and write blanks to the video buffer.

Modem Use IRQ

This determines the IRQ in which the MODEM can use.
The settings are: 3, 4, 5, 7, 9, 10, 11, NA.

Power Button Function

Pressing the power button for more than 4 seconds forces the system to enter the Soft-Off state. The settings are: Delay 4 Sec, Instant-Off.

PM Wake Up Events

Please refer to section 3-8-1

3-8-1 PM Wake Up Events

CMOS Setup Utility - Copyright(C) 1984-2001 Award Software

PM Wake Up Events

IRQ [3-7,9-15],NMI	Enabled	Item Help Menu Level >>
IRQ 8 Break Suspend	Disabled	
RING Power Up Control	Disabled	
MACPME Power UP Control	Disabled	
KB Power ON Password	Enter	
Power Up by Alarm	Disabled	
x Month Alarm	NA	
x Day of Month Alarm	NA	
x Time (hh:mm:ss) Alarm	0 : 0 : 0	
↑ ↓ → ← Move Enter:Select +/-/PU/PD:Value F10:Save ESC:Exit F1:General Help F5:Previous Values F6:Optimized Defaults F7:Standard Defaults		

Ring Power Up Control

During Disabled, the system will ignore any incoming call from the modem. During Enabled, the system will boot up if there's an incoming call from the modem.

PCIPME Power Up Control

This will enable the system to wake up by PCI device Power Management function. The settings are: Enabled and Disabled.

KB Power ON Password

This item can setting Power On Password, if you Enabled keyboard Power On function then you can Power On system by key-in the password which you setting.

Power Up by Alarm

This function is for setting date and time for your computer to boot up. During Disabled, you cannot use this function. During Enabled, choose the Date and Time Alarm:

Date(of month) Alarm

You can choose which month the system will boot up. Set to 0, to boot every day.

Time(hh:mm:ss) Alarm

You can choose what hour, minute and second the system will boot up.

Note: If you have change the setting, you must let the system boot up until it goes to the operating system, before this function will work.

3-9 PnP/PCI Configuration Setup

This section describes configuring the PCI bus system. PCI, or Personal Computer Interconnect, is a system which allows I/O devices to operate at speeds nearing the speed the CPU itself uses when communicating with its own special components. This section covers some very technical items and it is strongly recommended that only experienced users should make any changes to the default settings.

CMOS Setup Utility - Copyright(C) 1984-2001 Award Software
PnP/PCI Configurations

Reset Configuration Data	Disabled	Item Help
Resources Controlled By	Manual	
> IRQ Resources	Press Enter	Menu Level >
PCI/VGA Palette Snoop	Disabled	Default is Disabled.
Assign IRQ For VGA	Enabled	Select Enabled to
Assign IRQ For USB	Enabled	reset Extended System
		Configuration Data
		(ESCD) when you exit
		Setup if you have
		installed a new add-on
		and the system
		reconfiguration has
		caused such a serious
		conflict that the OS
		cannot boot
↑ ↓ → ← Move Enter:Select +/-/PU/PD:Value F10:Save ESC:Exit F1:General Help F5:Previous Values F6:Optimized Defaults F7:Standard Defaults		

Reset Configuration Data

Normally, you leave this field Disabled. Select Enabled to reset Extended System Configuration Data (ESCD) when you exit Setup if you have installed a new add-on and the system reconfiguration has caused such a serious conflict that the operating system can not boot. The settings are: Enabled and Disabled.

Resource Controlled By

The Award Plug and Play BIOS has the capacity to automatically configure all of the boot and Plug and Play compatible devices. However, this capability means absolutely nothing unless you are using a Plug and Play operating system such as Windows®95/98. If you set this field to “manual” choose specific resources by going into each of the sub menu that follows this field (a sub menu is preceded by a “>”).

The settings are: Auto(ESCD), Manual.

IRQ Resources

When resources are controlled manually, assign each system interrupt a type, depending on the type of device using the interrupt.

Please refer to section 3-9-1

PCI/VGA Palette Snoop

Leave this field at *Disabled*. The settings are Enabled, Disabled.

3-9-1 IRQ Resources

CMOS Setup Utility - Copyright(C) 1984-2001 Award Software

IRQ Resources

IRQ-3 assigned to	PCI Device	Item Help	
IRQ-4 assigned to	PCI Device		
IRQ-5 assigned to	PCI Device	Menu Level >>	
IRQ-7 assigned to	PCI Device		
IRQ-9 assigned to	PCI Device		
IRQ-10 assigned to	PCI Device		
IRQ-11 assigned to	PCI Device		
IRQ-14 assigned to	PCI Device		
IRQ-15 assigned to	PCI Device		
↑ ↓ → ← Move Enter:Select +/-/PU/PD:Value F10:Save ESC:Exit F1:General Help F5:Previous Values F6:Optimized Defaults F7:Standard Defaults			

3-10 PC Health Status

This section shows the Status of you CPU, Fan, Warning for overall system status. This is only available if there is Hardware Monitor onboard.

CMOS Setup Utility - Copyright(C) 1984-2001 Award Software

PC Health Status

Shutdown Temperature	Disabled	Item Help
Show PC Health in Post	Enabled	
Vcore	1.5V	Menu Level >
VccVid	1.18V	
Vcc3	3.3V	
Vcc5	5.01V	
+12V	12.02V	
SB3V	3.31V	
-12V	-11.95V	
SB5V	5.02V	
Vbat	3.01V	
CPU Temperature	43°C/109°C	
System Temperature	33°C/91°C	
CPU Fan	5500 RPM	
System Fan	0 RPM	
↑ ↓ → ← Move Enter:Select +/-/PU/PD:Value F10:Save ESC:Exit F1:General Help F5:Previous Values F6:Optimized Defaults F7:Standard Defaults		

Show PC Health in Post

During Enabled, it displays information list below. The choice is either Enabled or Disabled

**Current CPU Temperature/Current System Temp/Current CPUFAN, SYSFAN Speed/
Vcore/ Vcc/3.3V/+5V/+12V/-12V/5VSB(V)**

This will show the CPU/FAN/System voltage chart and FAN Speed.

3-11 Miscellaneous Control

This section is for setting CPU Frequency Control.

CMOS Setup Utility - Copyright(C) 1984-2001 Award Software
Miscellaneous Control

CPU Clock Ratio	10 X	Item Help
Auto Detect DIMM/PCI Clock	Enabled	
Spread Spectrum	Disabled	
Clock Control	By Hardware	Menu Level >
** Current Host Clock is 100/33MHz **		
HOST/PCI Clock at Next Boot is 100/33MHz		
** Current DRAM Clock is 100 MHz **		
DRAM Clock at Next Boot is 100MH (HOST CLK)		
↑ ↓ → ← Move Enter:Select +/-/PU/PD:Value F10:Save ESC:Exit F1:General Help F5:Previous Values F6:Optimized Defaults F7:Standard Defaults		

Auto Detect DIMM/PCI Clock

This item allows you to enable/disable auto detect DIMM/PCI Clock.

The settings are: Enabled, Disabled.

Clock Control

This item allows you to set the CPU Host Clock by Hardware (CPU/PCI 100/33MHz) or by Software (BIOS)

Host/PCI clock at Next boot is

When Clock Control setting By Software this item allows you to set CPU Host Clock step by step from 100MHz to 200MHz, use Page Down/Page Up key can change the frequency to approach over clocking.

DRAM Clock at Next Boot is

This item allows you to set the DRAM clock synchronous as CPU Host Clock or Asynchronous as Host clock 100MHz, 133MHz, 166MHz to approach your DDR SDRAM specification.

3-12 Load Standard/Optimized Defaults

Load Standard Defaults

When you press <Enter> on this item, you get confirmation dialog box with a message similar to:

Load Standard Defaults (Y/N)? N

Pressing <Y> loads the BIOS default values for the most stable, minimal-performance system operations.

Load Optimized Defaults

When you press <Enter> on this item, you get a confirmation dialog box with a message similar to:

Load Optimized Defaults (Y/N)? N

Pressing <Y> loads the default values that are factory settings for optimal performance system operations.

3-13 Set Supervisor/User Password

You can set either supervisor or user password, or both of them. The differences are:

Supervisor password: Can enter and change the options of the setup menus.

User password: Can only enter but do not have the right to change the options of the setup menus. When you select this function, the following message will appear at the center of the screen to assist you in creating a password.

ENTER PASSWORD:

Type the password, up to eight characters in length, and press <Enter>. The password typed now will clear any previously entered password from CMOS memory. You will be asked to confirm the password. Type the password again and press <Enter>. You may also press <Esc> to abort the selection and not enter a password.

To disable a password, just press <Enter> when you are prompted to enter the password. A message will confirm that the password will be disabled. Once the password is disabled, the system will boot and you can enter Setup freely.

PASSWORD DISABLED.

When a password has been enabled, you will be prompted to enter it every time you try to enter Setup. This prevents an unauthorized person from changing any part of your system configuration.

Additionally, when a password is enabled, you can also require the BIOS to request a password every time your system is rebooted. This would prevent unauthorized use of your computer.

You determine when the password is required within the BIOS Features Setup Menu and its Security option. If the Security option is set to “System”, the password will be required both at boot and at entry to Setup. If set to “Setup”, prompting only occurs when trying to enter Setup.

Chapter 4

DRIVER & FREE PROGRAM INSTALLATION

Check your package and there is A MAGIC INSTALL CD included. This CD consists of all DRIVERS you need and some free application programs and utility programs. In addition, this CD also include an auto detect software which can tell you which hardware is installed, and which DRIVERS needed so that your system can function properly. We call this auto detect software MAGIC INSTALL.

MAGIC INSTALL Supports WINDOWS 95/98/98SE/ME/NT4.0/2000

Insert CD into your CD-ROM drive and the MAGIC INSTALL Menu should appear as below. If the menu does not appear, double-click MY COMPUTER / double-click CD-ROM drive or click START / click RUN / type X:\SETUP.EXE (assuming X is your CD-ROM drive).

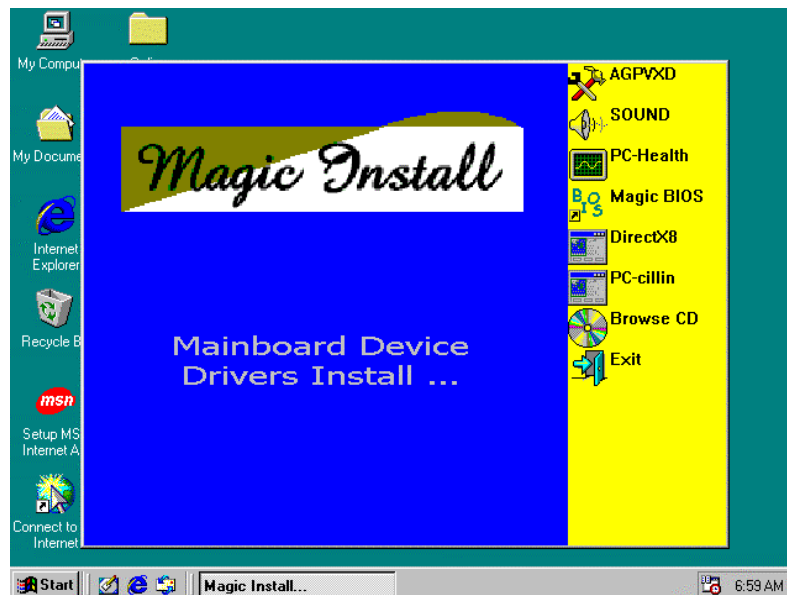

From MAGIC INSTALL MENU you may make 8 selections:

1. AGPVXD Install AGPVXD file when use External AGP card
2. SOUND install ALC201 Audio Codec driver
3. PC-HEALTH installs SMART GUARDIAN software for hardware monitoring device
4. MAGIC BIOS install BIOS Live Update Utility
5. DIRECTX8 install Microsoft DirectX 8.0 driver
6. PC-CILLIN install PC-CILLIN2000 anti-virus program
7. BROWSE CD to browse the contents of the CD
8. EXIT to exit from MAGIC INSTALL menu

4-1 AGPVXD Install SiS AGPVXD Driver

The AGPVXD Driver is Only For AGP Slot VGA CARD User, before install AGP card driver please install this AGPVXD driver first.

The path of the file:

for WINDOWS 9X is X:\SIS645\AGPVXD\WIN9X\SETUP.EXE

(including WIN95/98/98SE/ME)

for WINDOWS 2000/XP is X:\SIS645\AGPVXD\WIN2K_XP\SETUP.EXE

For WINDOWS 95/98/98SE/ME/2000/XP

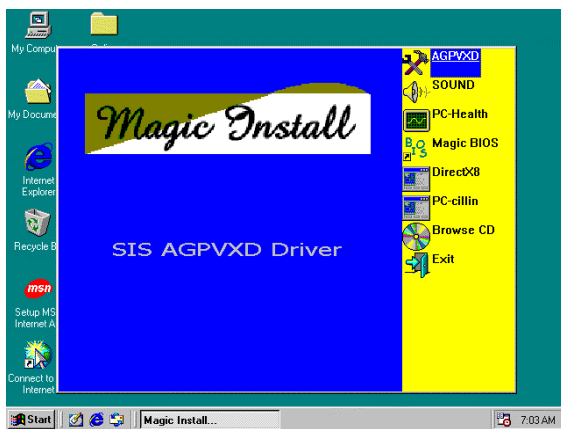

1. Click AGPVXD when Magic Install MENU appears

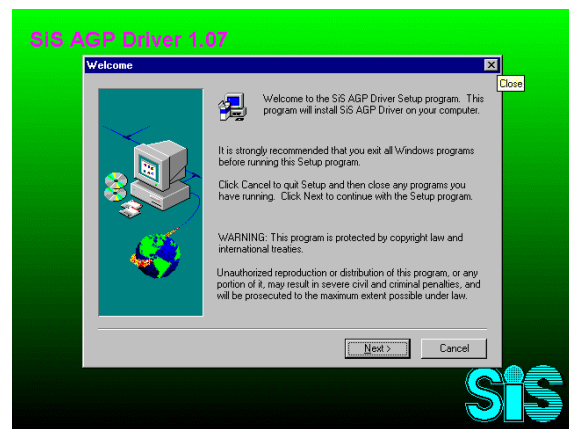

2. Click Next when SiS Acceleration Graphic Port appears

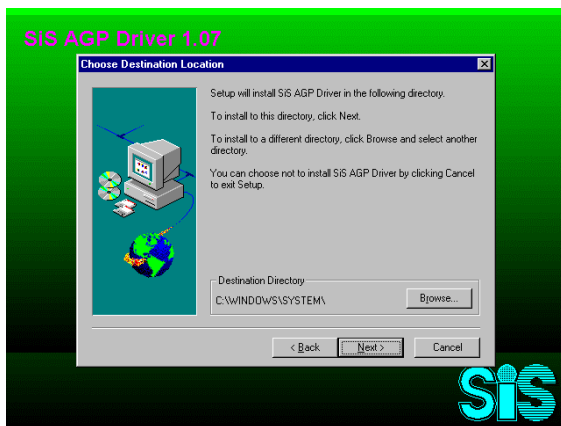

3. Click NEXT or choose BROWSE to change the path For the file to be stored

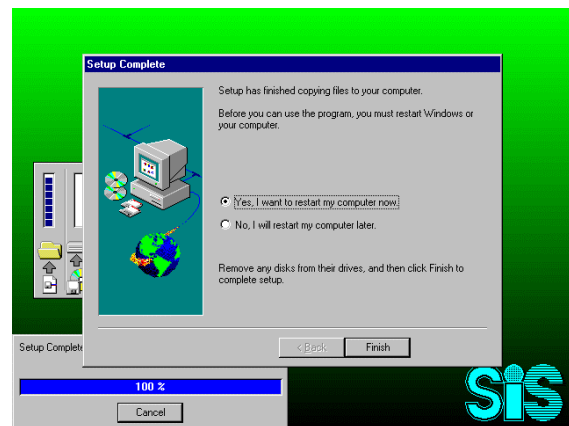

4. After Setup complete please select restart my computer now and click Finish to complete setup

4-2 SOUND Install ALC201 Audio Codec Driver

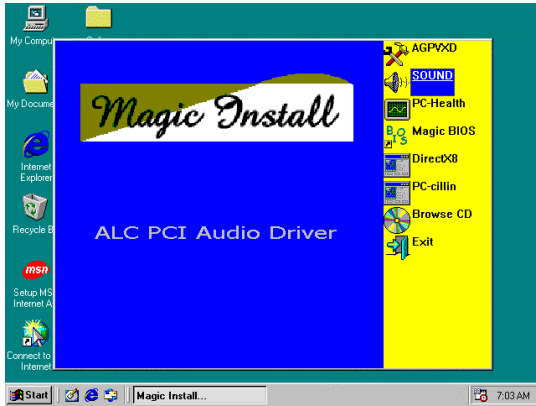

1. Click SOUND when MAGIC INSTALL MENU appears



2. Then auto detect operation system language edition, click Next, start to install DRIVER

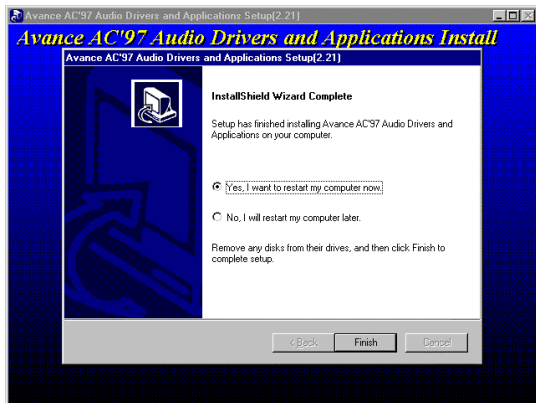

3. Click Finish and Restart Windows

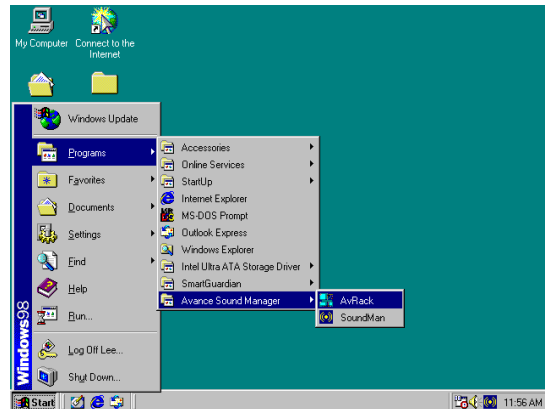

4. Click Start→Program→Avance Sound Manager→AvRack. Then AVRACK Windows appears

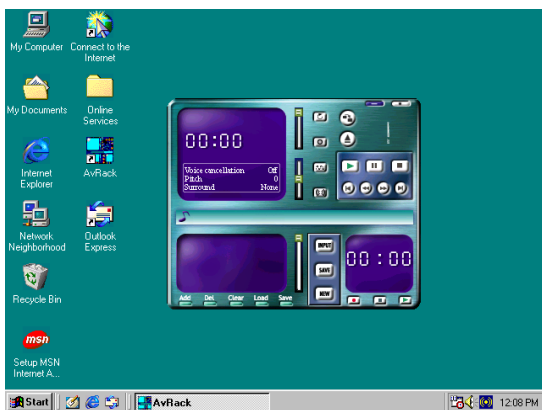

5. Avance Audio Rack table can play CD, WAV, MID, MP3, AVI, MPG Format File

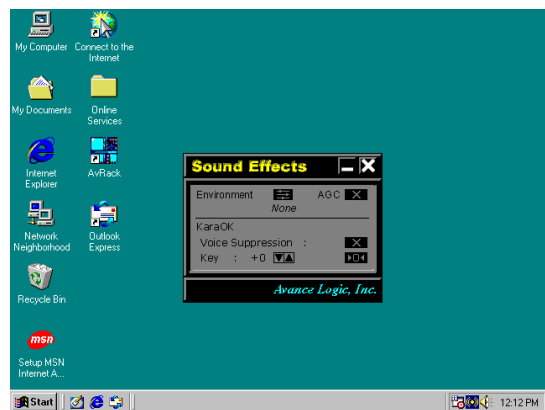

6. This is a Sound Environment Simulator and Karaoke function table

NOTE: MAGIC INSTALL will auto detect file path:

X:\SIS645\SOUND\SETUP.EXE (for WINDOWS 95/98/98SE/ME/NT4.0/2000/XP)

4-3 PC-HEALTH installs SMART GUARDIAN software for hardware monitoring device

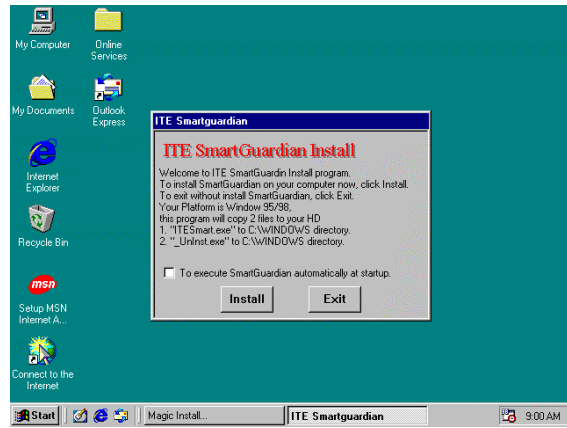
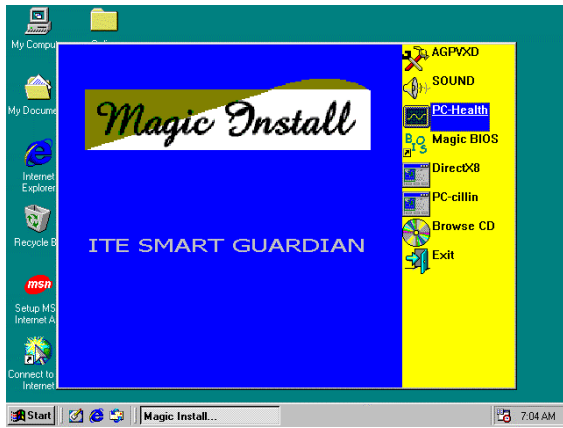

1. Click PC-HEALTH when MAGIC INSTALL MENU appears
2. Click Install when SMART GUARDIAN INSTALL appears

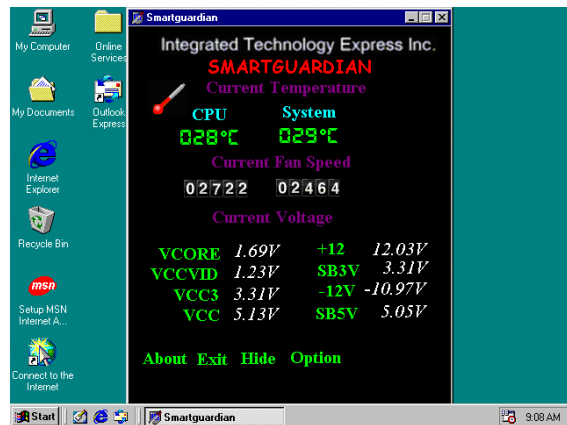
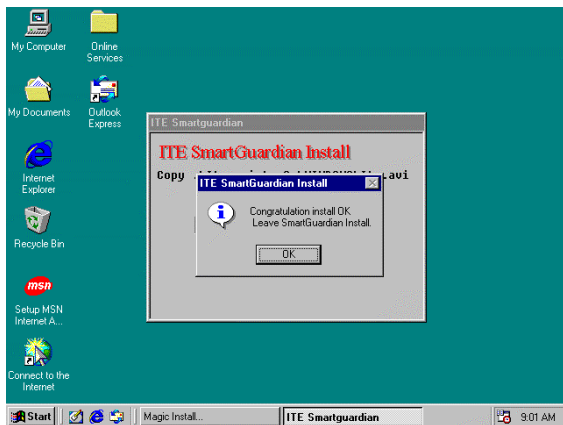

3. Click OK after the software is installed
4. SMART GUARDIAN Utility

**NOTE: MAGIC INSTALL will auto detect file path X:\SIS645\HEALTH\SETUP.EXE
This driver supports WINDOWS 95/98/98SE/NT4.0/2000**

