

**A8N-SLI**

**ASUS**<sup>®</sup>

**Motherboard**

**E2068**

**Revised Edition V2**

**April 2005**

**Copyright © 2005 ASUSTeK COMPUTER INC. All Rights Reserved.**

No part of this manual, including the products and software described in it, may be reproduced, transmitted, transcribed, stored in a retrieval system, or translated into any language in any form or by any means, except documentation kept by the purchaser for backup purposes, without the express written permission of ASUSTeK COMPUTER INC. ("ASUS").

Product warranty or service will not be extended if: (1) the product is repaired, modified or altered, unless such repair, modification or alteration is authorized in writing by ASUS; or (2) the serial number of the product is defaced or missing.

ASUS PROVIDES THIS MANUAL "AS IS" WITHOUT WARRANTY OF ANY KIND, EITHER EXPRESS OR IMPLIED, INCLUDING BUT NOT LIMITED TO THE IMPLIED WARRANTIES OR CONDITIONS OF MERCHANTABILITY OR FITNESS FOR A PARTICULAR PURPOSE. IN NO EVENT SHALL ASUS, ITS DIRECTORS, OFFICERS, EMPLOYEES OR AGENTS BE LIABLE FOR ANY INDIRECT, SPECIAL, INCIDENTAL, OR CONSEQUENTIAL DAMAGES (INCLUDING DAMAGES FOR LOSS OF PROFITS, LOSS OF BUSINESS, LOSS OF USE OR DATA, INTERRUPTION OF BUSINESS AND THE LIKE), EVEN IF ASUS HAS BEEN ADVISED OF THE POSSIBILITY OF SUCH DAMAGES ARISING FROM ANY DEFECT OR ERROR IN THIS MANUAL OR PRODUCT.

SPECIFICATIONS AND INFORMATION CONTAINED IN THIS MANUAL ARE FURNISHED FOR INFORMATIONAL USE ONLY, AND ARE SUBJECT TO CHANGE AT ANY TIME WITHOUT NOTICE, AND SHOULD NOT BE CONSTRUED AS A COMMITMENT BY ASUS. ASUS ASSUMES NO RESPONSIBILITY OR LIABILITY FOR ANY ERRORS OR INACCURACIES THAT MAY APPEAR IN THIS MANUAL, INCLUDING THE PRODUCTS AND SOFTWARE DESCRIBED IN IT.

Products and corporate names appearing in this manual may or may not be registered trademarks or copyrights of their respective companies, and are used only for identification or explanation and to the owners' benefit, without intent to infringe.

# Contents

|                                      |      |
|--------------------------------------|------|
| Notices .....                        | vi   |
| Safety information .....             | vii  |
| A8N-SLI specifications summary ..... | viii |

## Chapter 1: Hardware information

|     |   |      |
|-----|---|------|
| 1.1 | Before you proceed .....                    | 1-2  |
| 1.2 | Motherboard overview .....                  | 1-3  |
|     | 1.2.1 Placement direction .....             | 1-3  |
|     | 1.2.2 Screw holes .....                     | 1-3  |
|     | 1.2.3 Motherboard layout .....              | 1-4  |
|     | 1.2.4 Layout contents .....                 | 1-5  |
| 1.3 | Central Processing Unit (CPU) .....         | 1-7  |
|     | 1.3.1 Installing the CPU .....              | 1-7  |
|     | 1.3.2 Installing the heatsink and fan ..... | 1-9  |
| 1.4 | System memory .....                         | 1-12 |
|     | 1.4.1 Overview .....                        | 1-12 |
|     | 1.4.2 Memory configurations .....           | 1-12 |
|     | 1.4.3 Installing a DIMM .....               | 1-13 |
|     | 1.4.4 Removing a DIMM .....                 | 1-13 |
| 1.5 | Expansion slots .....                       | 1-14 |
|     | 1.5.1 Installing an expansion card .....    | 1-14 |
|     | 1.5.2 Configuring an expansion card .....   | 1-14 |
|     | 1.5.3 PCI slots .....                       | 1-16 |
|     | 1.5.4 PCI Express x16 slot .....            | 1-16 |
|     | 1.5.5 PCI Express x1 slot .....             | 1-16 |
| 1.6 | Jumper .....                                | 1-17 |
| 1.7 | Connectors .....                            | 1-18 |
|     | 1.7.1 Rear panel connectors .....           | 1-18 |
|     | 1.7.2 Internal connectors .....             | 1-20 |

# Contents

## Chapter 2: BIOS setup

|       |  |      |
|-------|--|------|
| 2.1   | Managing and updating your BIOS .....              | 2-2  |
| 2.1.1 | Creating a bootable floppy disk .....              | 2-2  |
| 2.1.2 | AwardBIOS Flash Utility .....                      | 2-3  |
| 2.1.3 | ASUS CrashFree BIOS 2 utility .....                | 2-7  |
| 2.2   | BIOS Setup program .....                           | 2-8  |
| 2.2.1 | BIOS menu bar .....                                | 2-9  |
| 2.2.2 | Legend bar .....                                   | 2-9  |
| 2.3   | Main Menu .....                                    | 2-11 |
| 2.3.1 | System Time .....                                  | 2-11 |
| 2.3.2 | System Date .....                                  | 2-11 |
| 2.3.3 | Legacy Diskette A .....                            | 2-11 |
| 2.3.4 | Installed Memory .....                             | 2-11 |
| 2.3.5 | Primary and Secondary IDE Master/Slave .....       | 2-12 |
| 2.3.6 | First, Second, Third, and Fourth SATA Master ..... | 2-14 |
| 2.3.7 | Installed Memory .....                             | 2-15 |
| 2.4   | Advanced Menu .....                                | 2-16 |
| 2.4.1 | CPU configuration .....                            | 2-17 |
| 2.4.2 | Chipset configuration .....                        | 2-18 |
| 2.4.3 | PCI/PnP .....                                      | 2-20 |
| 2.4.4 | Onboard device configuration .....                 | 2-22 |
| 2.5   | Power Menu .....                                   | 2-28 |
| 2.5.1 | APM configuration .....                            | 2-29 |
| 2.5.2 | Hardware monitor .....                             | 2-31 |
| 2.6   | Boot Menu .....                                    | 2-32 |
| 2.6.1 | Boot Device Priority .....                         | 2-33 |
| 2.6.2 | Hard Disk Drives .....                             | 2-33 |
| 2.6.3 | Boot settings configuration .....                  | 2-34 |
| 2.6.4 | Security .....                                     | 2-36 |
| 2.7   | Exit menu .....                                    | 2-37 |

## **Chapter 3: NVIDIA® SLI™ technology support**

|       |  |      |
|-------|--|------|
| 3.1   | Overview.....                                    | 3-2  |
| 3.1.1 | Requirements.....                                | 3-2  |
| 3.1.2 | ASUS Certified SLI Graphics cards .....          | 3-2  |
| 3.2   | Dual graphics card setup .....                   | 3-4  |
| 3.2.1 | Setting the ASUS EZ selector card .....          | 3-4  |
| 3.2.2 | Installing SLI-ready graphics cards .....        | 3-6  |
| 3.2.3 | Installing the device drivers .....              | 3-10 |
| 3.2.4 | Enabling the multi-GPU feature in Windows® ..... | 3-10 |

# Notices

## Federal Communications Commission Statement

This device complies with Part 15 of the FCC Rules. Operation is subject to the following two conditions:

- This device may not cause harmful interference, and
- This device must accept any interference received including interference that may cause undesired operation.

This equipment has been tested and found to comply with the limits for a Class B digital device, pursuant to Part 15 of the FCC Rules. These limits are designed to provide reasonable protection against harmful interference in a residential installation. This equipment generates, uses and can radiate radio frequency energy and, if not installed and used in accordance with manufacturer's instructions, may cause harmful interference to radio communications. However, there is no guarantee that interference will not occur in a particular installation. If this equipment does cause harmful interference to radio or television reception, which can be determined by turning the equipment off and on, the user is encouraged to try to correct the interference by one or more of the following measures:

- Reorient or relocate the receiving antenna.
- Increase the separation between the equipment and receiver.
- Connect the equipment to an outlet on a circuit different from that to which the receiver is connected.
- Consult the dealer or an experienced radio/TV technician for help.



---

The use of shielded cables for connection of the monitor to the graphics card is required to assure compliance with FCC regulations. Changes or modifications to this unit not expressly approved by the party responsible for compliance could void the user's authority to operate this equipment.

---

## Canadian Department of Communications Statement

This digital apparatus does not exceed the Class B limits for radio noise emissions from digital apparatus set out in the Radio Interference Regulations of the Canadian Department of Communications.

**This class B digital apparatus complies with Canadian ICES-003.**

# Safety information

## Electrical safety

- To prevent electrical shock hazard, disconnect the power cable from the electrical outlet before relocating the system.
- When adding or removing devices to or from the system, ensure that the power cables for the devices are unplugged before the signal cables are connected. If possible, disconnect all power cables from the existing system before you add a device.
- Before connecting or removing signal cables from the motherboard, ensure that all power cables are unplugged.
- Seek professional assistance before using an adapter or extension cord. These devices could interrupt the grounding circuit.
- Make sure that your power supply is set to the correct voltage in your area. If you are not sure about the voltage of the electrical outlet you are using, contact your local power company.
- If the power supply is broken, do not try to fix it by yourself. Contact a qualified service technician or your retailer.

## Operation safety

- Before installing the motherboard and adding devices on it, carefully read all the manuals that came with the package.
- Before using the product, make sure all cables are correctly connected and the power cables are not damaged. If you detect any damage, contact your dealer immediately.
- To avoid short circuits, keep paper clips, screws, and staples away from connectors, slots, sockets and circuitry.
- Avoid dust, humidity, and temperature extremes. Do not place the product in any area where it may become wet.
- Place the product on a stable surface.
- If you encounter technical problems with the product, contact a qualified service technician or your retailer.

## A8N-SLI specifications summary

|                         |  |
|-------------------------|--|
| <b>CPU</b>              | Socket 939 for AMD Athlon™ 64FX/AMD Athlon™ 64 processor<br>Supports AMD 64 architecture that enables simultaneous 32-bit and 64-bit architecture                    |
| <b>Chipset</b>          | NVIDIA® nForce™4 SLI   |
| <b>Front Side Bus</b>   | 1 GHz (K8) / 800 MHz   |
| <b>Memory</b>           | Dual-channel memory architecture<br>4 x 184-pin DIMM sockets support non-ECC unbuffered 400 MHz DDR memory modules<br>Supports up to 2 GB system memory              |
| <b>Expansion slots</b>  | 2 x PCI Express™ x16 slot for discrete graphics cards*<br>2 x PCI Express™ x1 slots<br>3 x PCI slots   |
| <b>Storage</b>          | NVIDIA® nForce™4 SLI chipset supports:<br>- 4 x Ultra DMA 133/100/66/33 hard disk drives<br>- 4 x Serial ATA drives with RAID 0, RAID 1, and RAID 0+1 configurations |
| <b>Audio</b>            | Realtek® ALC850 8-channel CODEC<br>1 x Coaxial S/PDIF out port<br>1 x Optical S/PDIF out port  |
| <b>LAN</b>              | Marvell® 88E81111 PCI Express™ Gigabit LAN controller  |
| <b>IEEE 1394</b>        | T1 1394a controller supports:<br>- 2 x IEEE 1394a ports  |
| <b>USB</b>              | Supports up to 10 USB 2.0 ports  |
| <b>BIOS features</b>    | 4 Mb Flash ROM, Phoenix-Award BIOS, LPC, Green, PnP, DMI2.0, WfM2.0, SM BIOS 2.3, ACPI 2.0a  |
| <b>Special features</b> | ASUS Q-Fan2<br>ASUS My Logo2™<br>ASUS EZ Flash<br>ASUS Crash Free BIOS 2   |

*(continued on the next page)*



## A8N-SLI specifications summary

|                            |   |
|----------------------------|---|
| <b>Rear panel</b>          | 1 x PS/2 mouse port<br>1 x Parallel port<br>1 x IEEE 1394a port<br>1 x LAN (RJ-45) port<br>4 x USB 2.0 ports<br>1 x Coaxial S/PDIF Out port<br>1 x Optical S/PDIF Out port<br>1 x PS/2 keyboard port<br>8-Channel audio ports   |
| <b>Internal connectors</b> | 1 x Floppy disk drive connector<br>2 x IDE connectors<br>4 x Serial ATA connectors<br>1 x CPU fan connector<br>2 x Chassis fan connectors<br>1 x Chipset fan connector<br>3 x USB connectors<br>1 x IEEE 1394a connector<br>1 x Serial port connector<br>1 x 24-pin ATX power connector<br>1 x 4-pin ATX 12V power connector<br>1 x Internal audio connector<br>1 x Optical drive audio<br>1x Front panel audio connector<br>1 x System panel connector |
| <b>Power requirement</b>   | ATX power supply (with 24-pin and 4-pin 12 V plugs)<br>ATX 12 V 2.0 compliant   |
| <b>Form factor</b>         | ATX form factor: 12 in x 9.6 in (30.5 cm x 24.4 cm)   |

\*Specifications are subject to change without notice.



This chapter lists the hardware setup procedures that you have to perform when installing system components. It includes description of the jumpers and connectors on the motherboard.

# **Hardware information**

## 1.1 Before you proceed

Take note of the following precautions before you install motherboard components or change any motherboard settings.



- Unplug the power cord from the wall socket before touching any component.
- Use a grounded wrist strap or touch a safely grounded object or a metal object, such as the power supply case, before handling components to avoid damaging them due to static electricity
- Hold components by the edges to avoid touching the ICs on them.
- Whenever you uninstall any component, place it on a grounded antistatic pad or in the bag that came with the component.
- **Before you install or remove any component, ensure that the ATX power supply is switched off or the power cord is detached from the power supply.** Failure to do so may cause severe damage to the motherboard, peripherals, and/or components.

## Onboard LEDs

The motherboard comes with a green standby power LED that lights up to indicate that the system is ON, in sleep mode, or in soft-off mode. This is a reminder that you should shut down the system and unplug the power cable before removing or plugging in any motherboard component.

The red warning LED lights up when you installed two graphics cards but did not connect the ASUS EZ Plug™. The illustration below shows the location of the onboard LEDs.

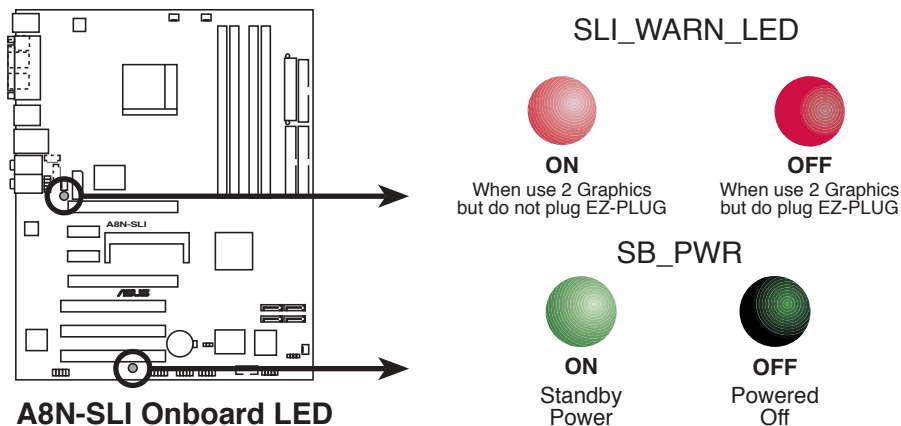

## 1.2 Motherboard overview

Before you install the motherboard, study the configuration of your chassis to ensure that the motherboard fits into it. Refer to the chassis documentation before installing the motherboard.



---

Make sure to unplug the power cord before installing or removing the motherboard. Failure to do so can cause you physical injury and damage motherboard components.

---

### 1.2.1 Placement direction

When installing the motherboard, make sure that you place it into the chassis in the correct orientation. The edge with external ports goes to the rear part of the chassis as indicated in the image below.

### 1.2.2 Screw holes

Place nine screws into the holes indicated by circles to secure the motherboard to the chassis.



---

Do not overtighten the screws! Doing so can damage the motherboard.

---

Place this side towards  
the rear of the chassis

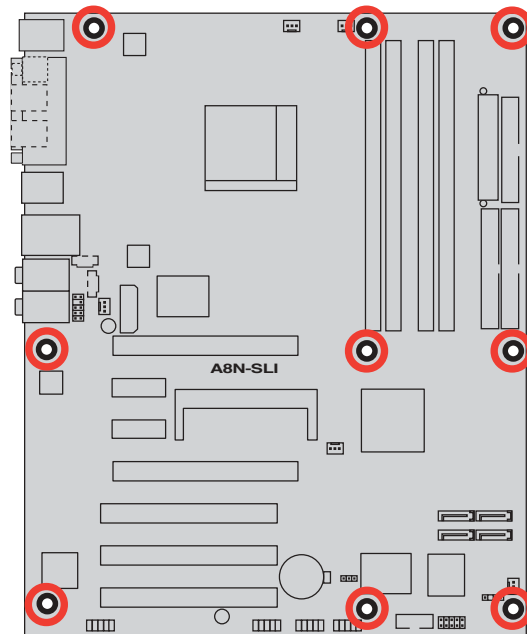

## 1.2.3 Motherboard layout

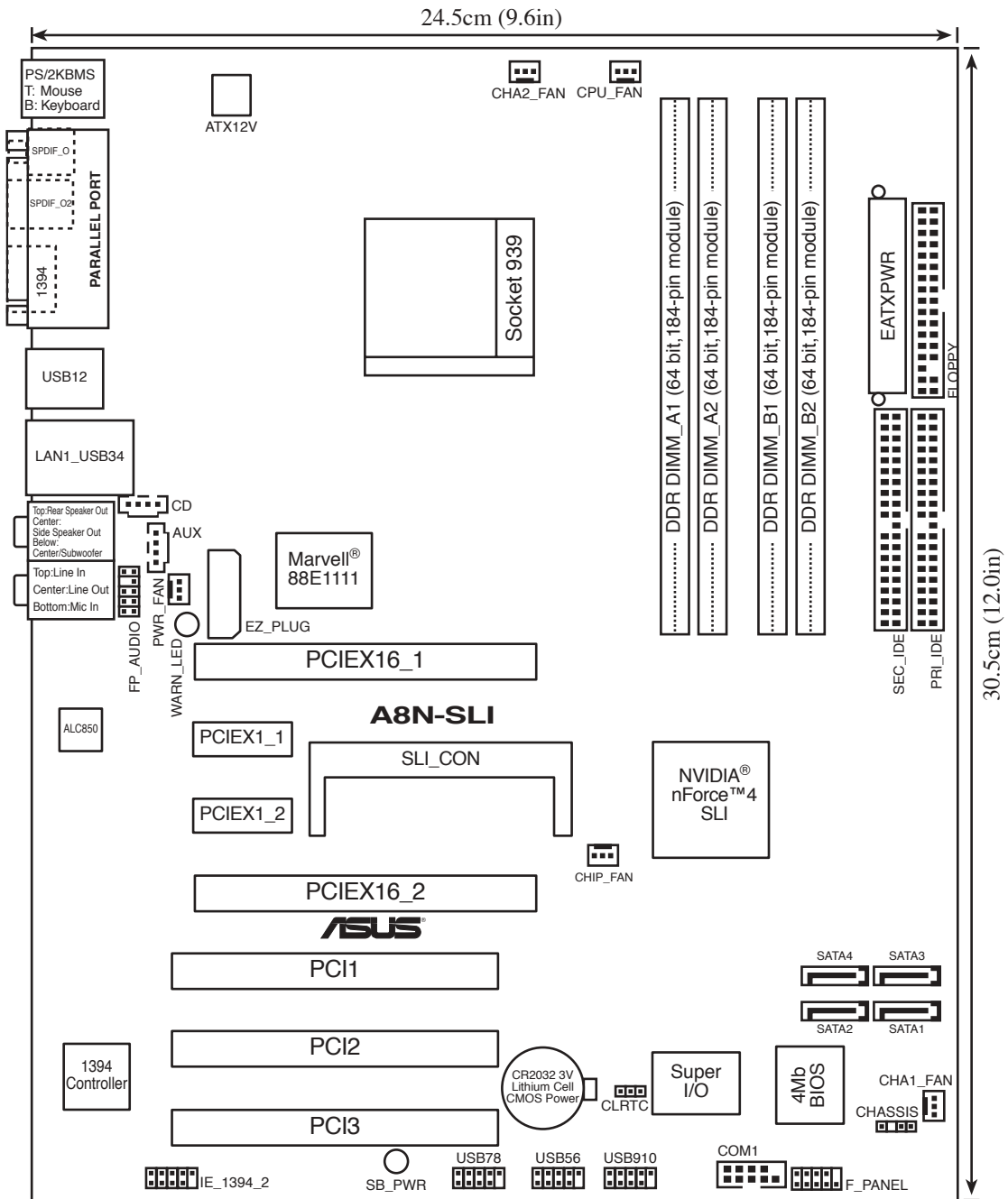

## 1.2.4 Layout contents

| Slots                   | Page |
|-------------------------|------|
| 1. DDR DIMM slots       | 1-12 |
| 2. PCI slots            | 1-16 |
| 3. PCI Express x16 slot | 1-16 |
| 4. PCI Express x1 slot  | 1-16 |

| Jumper                          | Page |
|---------------------------------|------|
| 1. Clear RTC RAM (3-pin CLRRTC) | 1-17 |

| Rear panel connectors       | Page |
|-----------------------------|------|
| 1. PS/2 mouse port          | 1-18 |
| 2. Parallel port            | 1-18 |
| 3. LAN (RJ-45) port         | 1-18 |
| 4. Rear Speaker Out port    | 1-18 |
| 5. Side Speaker Out port    | 1-18 |
| 6. Line In port             | 1-18 |
| 7. Line Out port            | 1-18 |
| 8. Microphone port          | 1-19 |
| 9. Center/Subwoofer port    | 1-19 |
| 10. USB 2.0 ports 3 and 4   | 1-19 |
| 11. USB 2.0 ports 1 and 2   | 1-19 |
| 12. IEEE 1394a port         | 1-19 |
| 13. Optical S/PDIF Out port | 1-19 |
| 14. Coaxial S/PDIF Out port | 1-19 |
| 15. PS/2 keyboard port      | 1-19 |

| Internal connectors   | Page |
|---|------|
| 1. Floppy disk drive connector (34-1 pin FLOPPY1)                       | 1-20 |
| 2. Serial port connector (10-1 pin COM1)                                | 1-20 |
| 3. IDE connectors (40-1 pin PRI_IDE, SEC_IDE)                           | 1-21 |
| 4. Serial ATA connectors (7-pin SATA1, SATA2, SATA3, SATA4)             | 1-22 |
| 5. CPU fan connector (3-pin CPU_FAN)                                    | 1-23 |
| 6. Chassis fan connectors (3-pin CHA1_FAN, CHA2_FAN)                    | 1-23 |
| 7. Chipset fan connector (3-pin CHIP_FAN)                               | 1-23 |
| 8. Power fan connector (3-pin PWR_FAN)                                  | 1-23 |
| 9. USB connectors (10-1 pin USB78, USB56, USB910)                       | 1-24 |
| 10. IEEE 1394a connector (10-1 pin IE_1394_2)                           | 1-24 |
| 11. ATX power connectors (24-pin EATXPWR, 4-pin ATX12V1, 4-pin EZ_PLUG) | 1-25 |
| 12. Internal audio connectors (4-pin AUX, 4-pin CD)                     | 1-26 |
| 13. Front panel audio connector (10-1 pin FP_AUDIO)                     | 1-26 |
| 14. Chassis intrusion connector (4-1 pin CHASSIS)                       | 1-27 |
| 15. System panel connector (10-1 pin FRONTANEL)                         | 1-28 |



## 1.3 Central Processing Unit (CPU)

The motherboard comes with a surface mount 939-pin Zero Insertion Force (ZIF) socket designed for the AMD Athlon™ 64FX or AMD Athlon™ 64 processor.

The 128-bit-wide data paths of these processors can run applications faster than processors with only 32-bit or 64-bit wide data paths.

Take note of the marked corner (with gold triangle) on the CPU. This mark should match a specific corner on the socket to ensure correct installation.

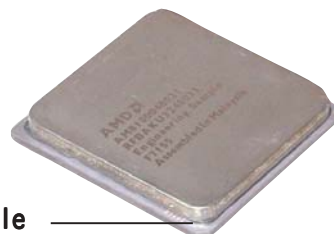

Gold triangle

### 1.3.1 Installing the CPU

To install a CPU:

1. Locate the CPU socket on the motherboard.

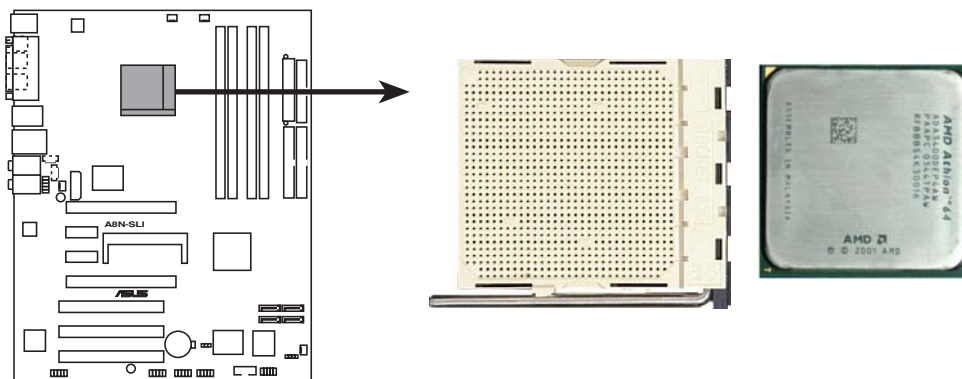

A8N-SLI CPU Socket 939

2. Unlock the socket by pressing the lever sideways, then lift it up to a 90°-100° angle.

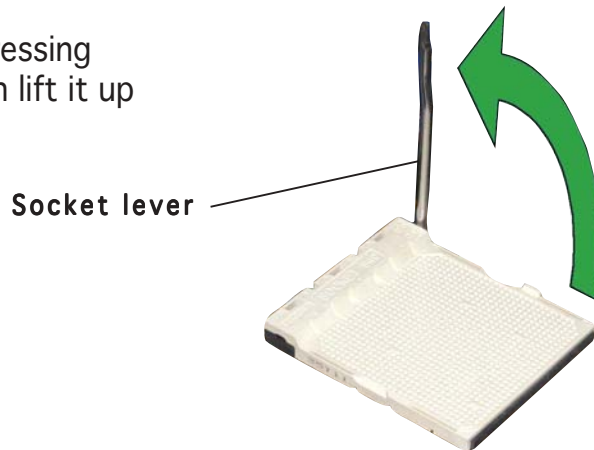

---

Make sure that the socket lever is lifted up to 90°-100° angle; otherwise the CPU does not fit in completely.

---

3. Position the CPU above the socket such that the CPU corner with the gold triangle matches the socket corner with a small triangle.
4. Carefully insert the CPU into the socket until it fits in place.

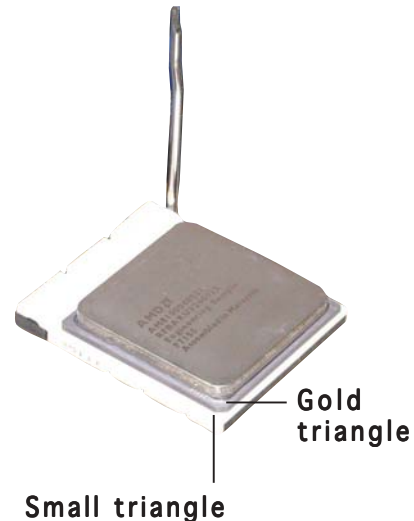

---

The CPU fits only in one correct orientation. DO NOT force the CPU into the socket to prevent bending the pins and damaging the CPU!

---

5. When the CPU is in place, push down the socket lever to secure the CPU. The lever clicks on the side tab to indicate that it is locked.

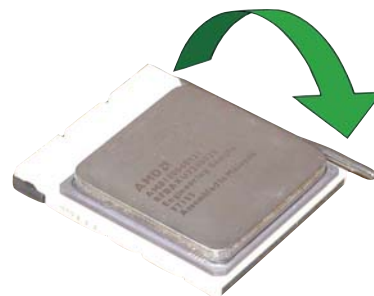

## 1.3.2 Installing the heatsink and fan

The AMD Athlon™ 64FX or AMD Athlon™ 64 processor requires a specially designed heatsink and fan assembly to ensure optimum thermal condition and performance.



---

Make sure that you use only qualified heatsink and fan assembly.

---

To install the CPU heatsink and fan:

1. Place the heatsink on top of the installed CPU, making sure that the heatsink fits properly on the retention module base.



- The retention module base is already installed on the motherboard upon purchase.
  - You do not have to remove the retention module base when installing the CPU or installing other motherboard components.
  - If you purchased a separate CPU heatsink and fan assembly, make sure that a Thermal Interface Material is properly applied to the CPU heatsink or CPU before you install the heatsink and fan assembly.
- 

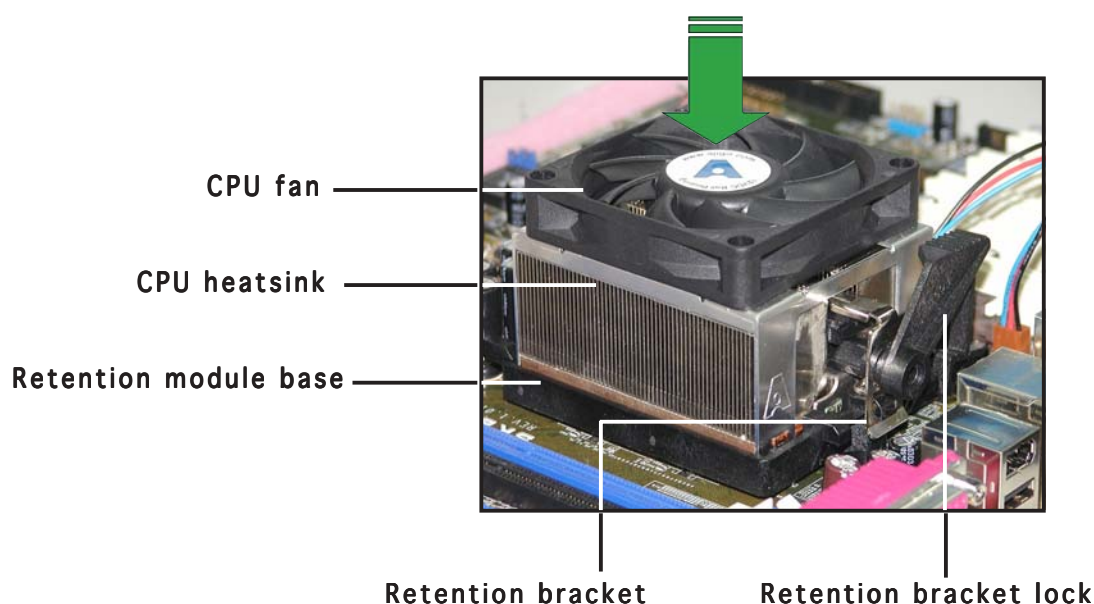

---

Your boxed CPU heatsink and fan assembly should come with installation instructions for the CPU, heatsink, and the retention mechanism. If the instructions in this section do not match the CPU documentation, follow the latter.

---

2. Attach one end of the retention bracket to the retention module base.

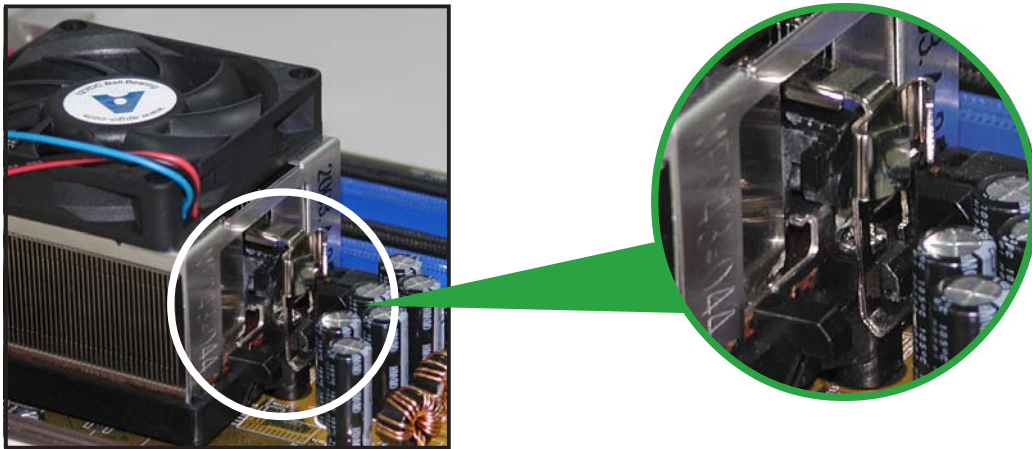

3. Align the other end of the retention bracket (near the retention bracket lock) to the retention module base. A clicking sound denotes that the retention bracket is in place.



Make sure that the fan and heatsink assembly perfectly fits the retention mechanism module base; otherwise, you cannot snap the retention bracket in place.



4. Push down the retention bracket lock on the retention mechanism to secure the heatsink and fan to the module base.

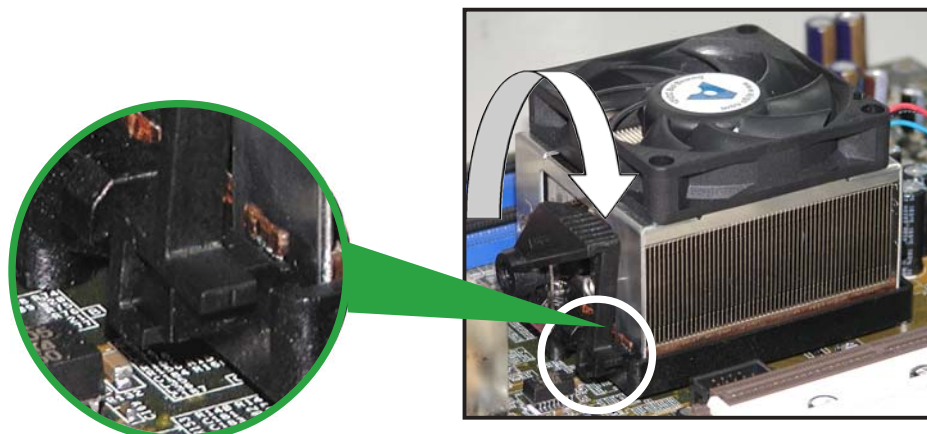

5. When the fan and heatsink assembly is in place, connect the CPU fan cable to the connector on the motherboard labeled CPU\_FAN.

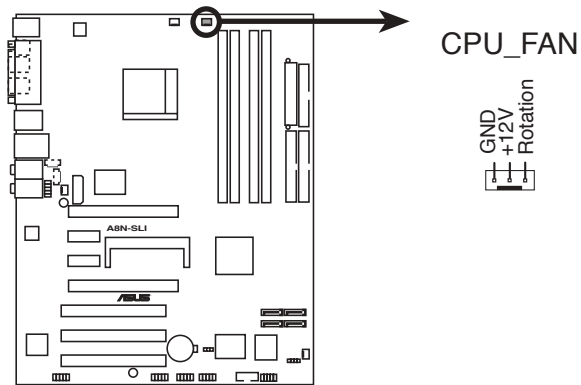

**A8N-SLI CPU fan connector**



---

Do not forget to connect the CPU fan connector! Hardware monitoring errors can occur if you fail to plug this connector.

---

## 1.4 System memory

### 1.4.1 Overview

The motherboard comes with four 184-pin Double Data Rate (DDR) Dual Inline Memory Modules (DIMM) sockets.

The following figure illustrates the location of the sockets:

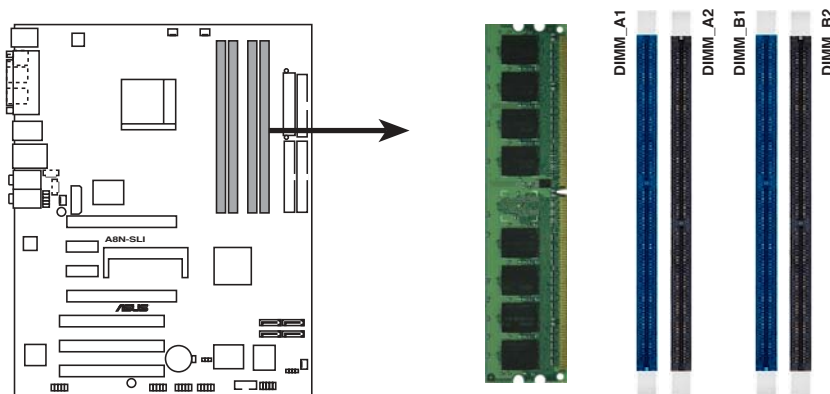

**A8N-SLI 184-pin DDR DIMM sockets**

| Channel   | Sockets             |
|-----------|---------------------|
| Channel A | DIMM_A1 and DIMM_A2 |
| Channel B | DIMM_B1 and DIMM_B2 |

### 1.4.2 Memory configurations

You may install 256 MB, 512 MB and 1 GB unbuffered non-ECC DDR DIMMs into the DIMM sockets using the memory configurations in this section.



- For dual-channel configuration, the total size of memory module(s) installed per channel must be the same for better performance (DIMM\_A1+DIMM\_A2=DIMM\_B1+DIMM\_B2).
- When using one DDR DIMM module, install into DIMM\_B1 slot only.
- When using two DDR DIMM modules, install into DIMM\_A1 and DIMM\_B1 slots only.
- Always install DIMMs with the same CAS latency. For optimum compatibility, we recommended that you obtain memory modules from the same vendor system builder's website for the latest qualified vendors list (QVL).
- Due to chipset resource allocation, the system may detect less than 4 GB of system memory when you installed four 1 GB DDR memory modules.
- Due to CPU limitation, this motherboard does not support DIMM modules with 128 Mb memory chips or double-sided x16 memory chips.

### 1.4.3 Installing a DIMM



Make sure to unplug the power supply before adding or removing DIMMs or other system components. Failure to do so may cause severe damage to both the motherboard and the components.

1. Unlock a DIMM socket by pressing the retaining clips outward.
2. Align a DIMM on the socket such that the notch on the DIMM matches the break on the socket.

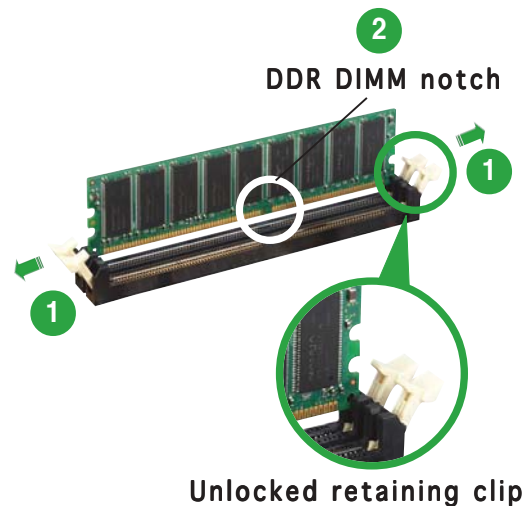

A DDR DIMM is keyed with a notch so that it fits in only one direction. DO NOT force a DIMM into a socket to avoid damaging the DIMM.

3. Firmly insert the DIMM into the socket until the retaining clips snap back in place and the DIMM is properly seated.

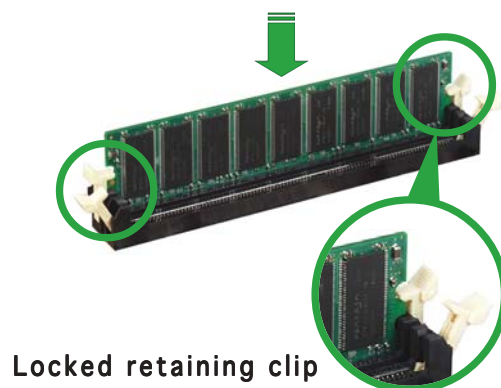

### 1.4.4 Removing a DIMM

To remove a DIMM:

1. Simultaneously press the retaining clips outward to unlock the DIMM.

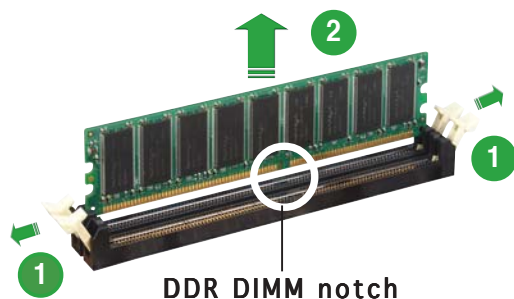

Support the DIMM lightly with your fingers when pressing the retaining clips. The DIMM might get damaged when it flips out with extra force.

2. Remove the DIMM from the socket.

## 1.5 Expansion slots

In the future, you may need to install expansion cards. The following sub-sections describe the slots and the expansion cards that they support.



---

Make sure to unplug the power cord before adding or removing expansion cards. Failure to do so may cause you physical injury and damage motherboard components.

---

### 1.5.1 Installing an expansion card

To install an expansion card:

1. Before installing the expansion card, read the documentation that came with it and make the necessary hardware settings for the card.
2. Remove the system unit cover (if your motherboard is already installed in a chassis).
3. Remove the bracket opposite the slot that you intend to use. Keep the screw for later use.
4. Align the card connector with the slot and press firmly until the card is completely seated on the slot.
5. Secure the card to the chassis with the screw you removed earlier.
6. Replace the system cover.

### 1.5.2 Configuring an expansion card

After installing the expansion card, configure it by adjusting the software settings.

1. Turn on the system and change the necessary BIOS settings, if any. See Chapter 2 for information on BIOS setup.
2. Assign an IRQ to the card. Refer to the tables on the next page.
3. Install the software drivers for the expansion card.



## Standard interrupt assignments

| IRQ | Priority | Standard Function            |
|-----|----------|------------------------------|
| 0   | 1        | System Timer                 |
| 1   | 2        | Keyboard Controller          |
| 2   | -        | Re-direct to IRQ#9           |
| 4   | 12       | Communications Port (COM1)*  |
| 5   | 13       | IRQ holder for PCI steering* |
| 6   | 14       | Floppy Disk Controller       |
| 7   | 15       | Printer Port (LPT1)*         |
| 8   | 3        | System CMOS/Real Time Clock  |
| 9   | 4        | IRQ holder for PCI steering* |
| 10  | 5        | IRQ holder for PCI steering* |
| 11  | 6        | IRQ holder for PCI steering* |
| 12  | 7        | PS/2 Compatible Mouse Port*  |
| 13  | 8        | Numeric Data Processor       |
| 14  | 9        | Primary IDE Channel          |
| 15  | 10       | Secondary IDE Channel        |

\* These IRQs are usually available for ISA or PCI devices.

## IRQ assignments for this motherboard

|                            | A      | B      | C      | D      | E | F | G | H |
|----------------------------|--------|--------|--------|--------|---|---|---|---|
| PCI slot 1                 | shared | —      | —      | —      | — | — | — | — |
| PCI slot 2                 | —      | shared | —      | —      | — | — | — | — |
| PCI slot 3                 | —      | —      | shared | —      | — | — | — | — |
| Onboard USB 1.0 controller | shared | —      | —      | —      | — | — | — | — |
| Onboard USB 2.0 controller | shared | —      | —      | —      | — | — | — | — |
| Onboard LAN1               | shared | —      | —      | —      | — | — | — | — |
| Onboard LAN2               | —      | shared | —      | —      | — | — | — | — |
| Onboard PCI SATA RAID (SI) | —      | —      | —      | shared | — | — | — | — |
| Onboard 1394a              | shared | —      | —      | —      | — | — | — | — |



When using PCI cards on shared slots, ensure that the drivers support “Share IRQ” or that the cards do not need IRQ assignments; otherwise, conflicts will arise between the two PCI groups, making the system unstable and the card inoperable.

### 1.5.3 PCI slots

The PCI slots support cards such as a LAN card, SCSI card, USB card, and other cards that comply with PCI specifications. The figure shows a LAN card installed on a PCI slot.

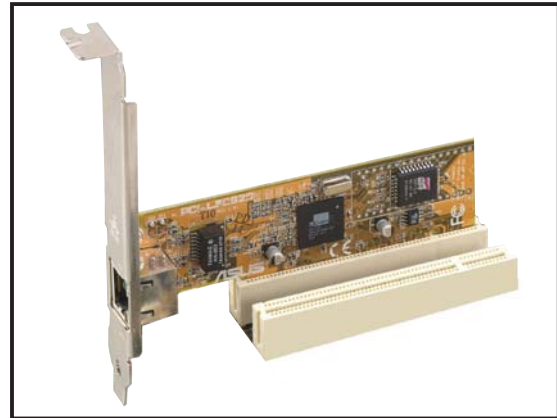

### 1.5.4 PCI Express x16 slot

This motherboard supports PCI Express x16 graphic cards that comply with the PCI Express specifications.

The figure shows a graphics card installed on the PCI Express x16 slot.

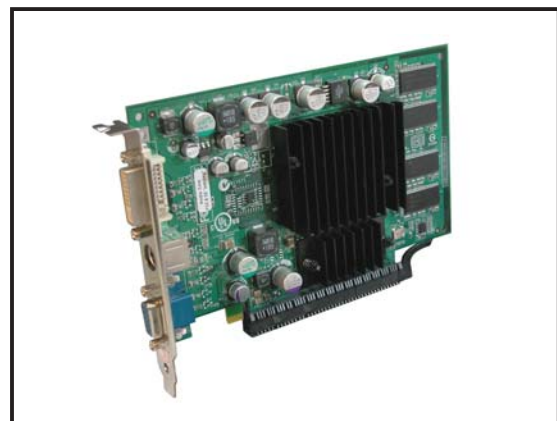

---

This motherboard does not support the Scalable Link Interface™ (SLI) mode for two identical SLI™-ready PCI Express x16 graphics cards.

Single card mode (default) supports:

- 1 x PCI Express™ x16 graphics card on either blue or black slot
- 

### 1.5.5 PCI Express x1 slot

This motherboard supports PCI Express x1 network cards, SCSI cards and other cards that comply with the PCI Express specifications. The figure shows a network card installed on the PCI Express x1 slot.

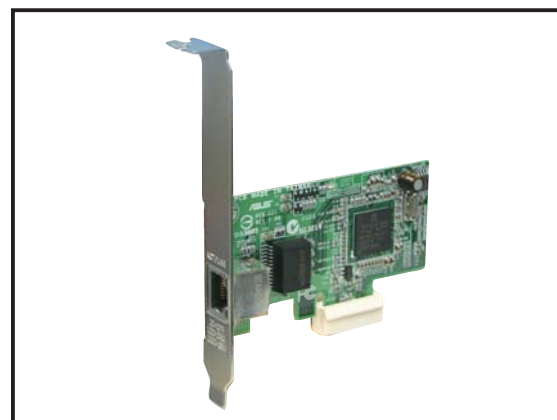

## 1.6 Jumper

### Clear RTC RAM (CLRTC)

This jumper allows you to clear the Real Time Clock (RTC) RAM in CMOS. You can clear the CMOS memory of date, time, and system setup parameters by erasing the CMOS RTC RAM data. The onboard button cell battery powers the RAM data in CMOS, which include system setup information such as system passwords.

To erase the RTC RAM:

1. Turn OFF the computer and unplug the power cord.
2. Move the jumper cap from pins 1-2 (default) to pins 2-3. Keep the cap on pins 2-3 for about 5~10 seconds, then move the cap back to pins 1-2.
3. Plug the power cord and turn ON the computer.
4. Hold down the <Del> key during the boot process and enter BIOS setup to re-enter data.



---

Except when clearing the RTC RAM, never remove the cap on CLRTC jumper default position. Removing the cap will cause system boot failure!

---

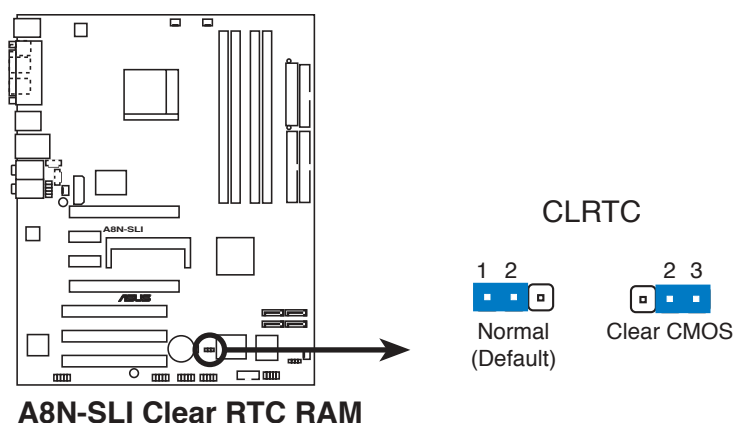

---

You do not need to clear the RTC when the system hangs due to overclocking. For system failure due to overclocking, use the C.P.R. (CPU Parameter Recall) feature. Shut down and reboot the system so the BIOS can automatically reset parameter settings to default values.

---

## 1.7 Connectors

### 1.7.1 Rear panel connectors

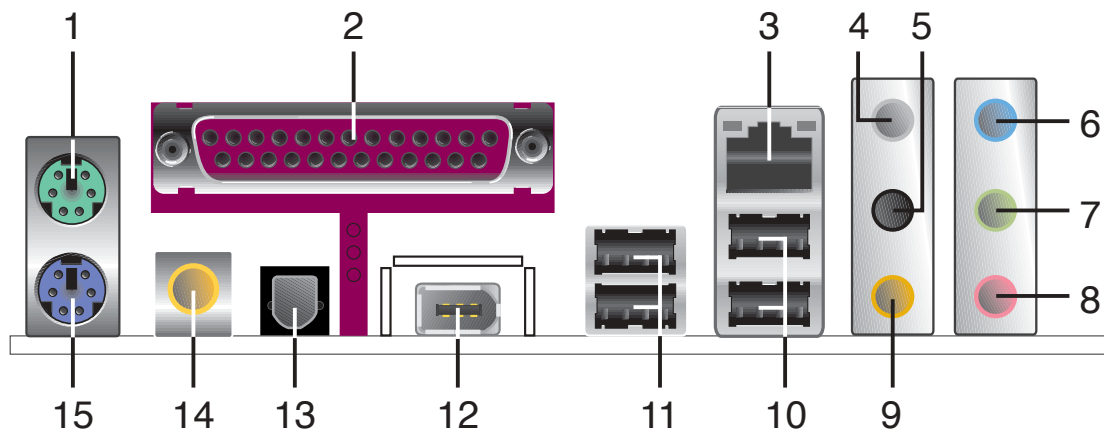

1. **PS/2 mouse port (green).** This port is for a PS/2 mouse.
2. **Parallel port.** This 25-pin port connects a parallel printer, a scanner, or other devices.
3. **LAN 2 (RJ-45) port.** Supported by the Marvell® 88E81111 Gigabit LAN controller, this port allows Gigabit connection to a Local Area Network (LAN) through a network hub.

#### LAN port LED indications

| ACT/LINK LED |               | SPEED LED |                     |
|--------------|---------------|-----------|---------------------|
| Status       | Description   | Status    | Description         |
| OFF          | No link       | OFF       | 10 Mbps connection  |
| GREEN        | Linked        | ORANGE    | 100 Mbps connection |
| BLINKING     | Data activity | GREEN     | 1 Gbps connection   |

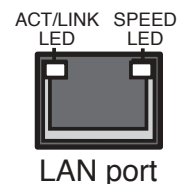

4. **Rear Speaker Out port (gray).** This port connects the rear speakers on a 4-channel, 6-channel, or 8-channel audio configuration.
5. **Side Speaker Out port (black).** This port connects the side speakers in an 8-channel audio configuration.
6. **Line In port (light blue).** This port connects the tape, CD, DVD player, or other audio sources.
7. **Line Out port (lime).** This port connects a headphone or a speaker. In 4-channel, 6-channel, and 8-channel configuration, the function of this port becomes Front Speaker Out.

8. **Microphone port (pink).** This port connects a microphone.
9. **Center/Subwoofer port (yellow orange).** This port connects the center/subwoofer speakers.



---

Refer to the audio configuration table below for the function of the audio ports in 2, 4, 6, or 8-channel configuration.

---

## Audio 2, 4, 6, or 8-channel configuration

| Port          | Headset<br>2-channel | 4-channel         | 6-channel         | 8-channel         |
|---------------|----------------------|-------------------|-------------------|-------------------|
| Light Blue    | Line In              | Line In           | Line In           | Line In           |
| Lime          | Line Out             | Front Speaker Out | Front Speaker Out | Front Speaker Out |
| Pink          | Mic In               | Mic In            | Mic In            | Mic In            |
| Gray          | -                    | Rear Speaker Out  | Rear Speaker Out  | Rear Speaker Out  |
| Black         | -                    | -                 | -                 | Side Speaker Out  |
| Yellow Orange | -                    | -                 | Center/Subwoofer  | Center/Subwoofer  |

10. **USB 2.0 ports 3 and 4.** These two 4-pin Universal Serial Bus (USB) ports are available for connecting USB 2.0 devices.
11. **USB 2.0 ports 1 and 2.** These two 4-pin Universal Serial Bus (USB) ports are available for connecting USB 2.0 devices.
12. **IEEE 1394a port.** This 6-pin IEEE 1394 port provides high-speed connectivity for audio/video devices, storage peripherals, PCs, or portable devices.
13. **Optical S/PDIF Out port.** This port connects an external audio output device via an optical S/PDIF cable.
14. **Coaxial S/PDIF Out port.** This port connects an external audio output device via a coaxial S/PDIF cable.
15. **PS/2 keyboard port (purple).** This port is for a PS/2 keyboard.

## 1.7.2 Internal connectors

### 1. Floppy disk drive connector (34-1 pin FLOPPY)

This connector is for the provided floppy disk drive (FDD) signal cable. Insert one end of the cable to this connector, then connect the other end to the signal connector at the back of the floppy disk drive.



The Pin 5 on the connector is removed to prevent incorrect cable connection when using an FDD cable with a covered Pin 5.

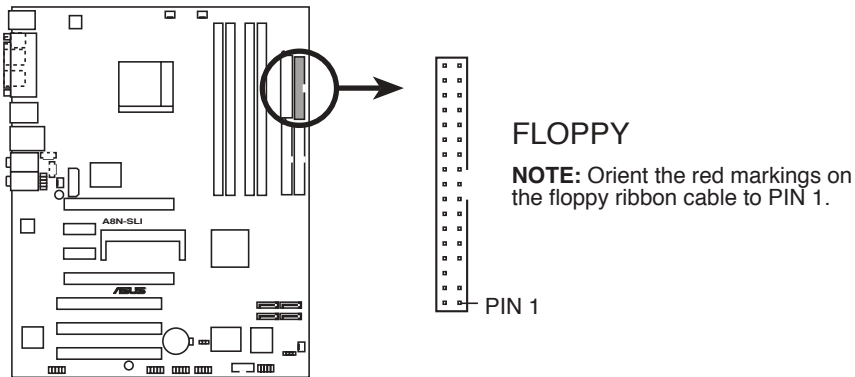

**A8N-SLI Floppy disk drive connector**

### 2. Serial port connector (10-1 pin COM1)

This connector is for a serial (COM) port. Connect the serial port module cable to this connector, then install the module to a slot opening at the back of the system chassis.

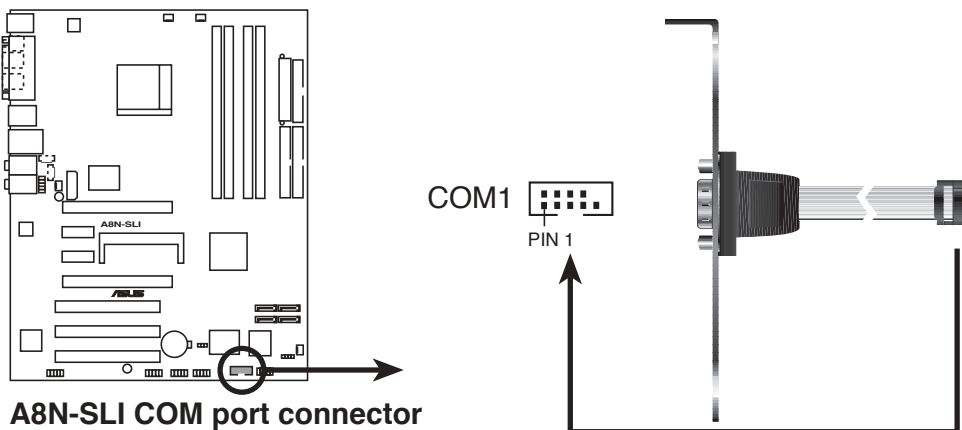

**A8N-SLI COM port connector**

### 3. IDE connectors (40-1 pin PRI\_IDE, SEC\_IDE)

These connectors are for Ultra DMA 133/100/66 signal cables. The Ultra DMA 133/100/66 signal cable has three connectors: a blue connector for the primary IDE connector on the motherboard, a black connector for an Ultra DMA 133/100/66 IDE slave device (optical drive/hard disk drive), and a gray connector for an Ultra DMA 133/100/66 IDE master device (hard disk drive). If you install two hard disk drives, you must configure the second drive as a slave device by setting its jumper accordingly. Refer to the hard disk documentation for the jumper settings.



- The Pin 20 on the IDE connector is removed to match the covered hole on the Ultra DMA cable connector. This prevents incorrect insertion when you connect the IDE cable.
- Use the 80-conductor IDE cable for UltraDMA133/100/66 IDE devices.

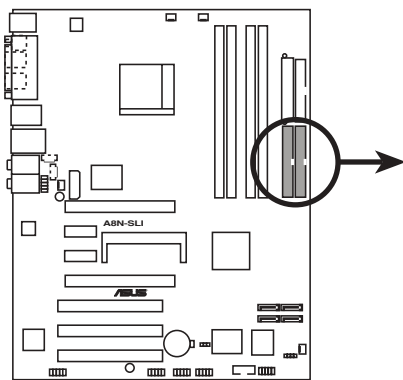

**A8N-SLI IDE connectors**

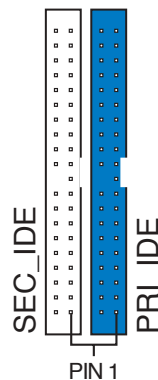

**NOTE:** Orient the red markings (usually zigzag) on the IDE ribbon cable to PIN 1.

#### 4. Serial ATA connectors (7-pin SATA1, SATA2, SATA3, SATA4)

Supported by the NVIDIA® nForce™4 SLI chipset, these connectors are for the Serial ATA signal cables for Serial ATA hard disk drives that allow up to 3Gb/s of data transfer rate.

If you installed Serial ATA hard disk drives, you can create a RAID 0, RAID 1, or RAID 1+0 configuration that span across the Parallel ATA drives.



These connectors are set to **SATA** by default. In SATA mode, you can connect Serial ATA boot or data hard disk drives to these connectors. If you intend to create a Serial ATA RAID set using these connectors, enable the RAID function of each port from the **NVRAID Configuration** sub-menu item in the BIOS. See section “2.4.3 Onboard Devices Configuration” on pages 2-24 and 2-26 for details.

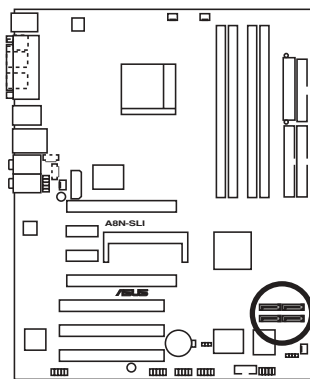

**A8N-SLI SATA connectors**

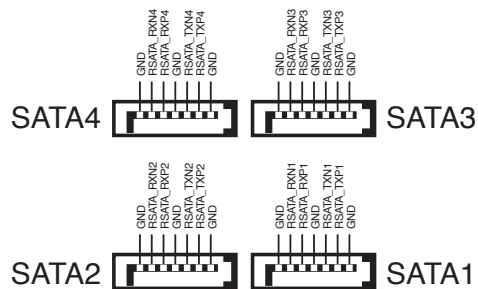

The actual data transfer rate depends on the speed of Serial ATA hard disks installed.

#### Serial ATA Master/Slave connectors

| Connector    | Color | Setting | Use       |
|--------------|-------|---------|-----------|
| SATA1, SATA2 | Black | Master  | Boot Disk |
| SATA3, SATA4 | Black | Slave   | Data Disk |



## 5. CPU, chassis, power, and chipset fan connectors (3-pin CPU\_FAN, 3-pin CHA1\_FAN, 3-pin CHA2\_FAN, 3-pin PWR\_FAN, 3-pin CHIP\_FAN))

These fan connectors support cooling fans of 350 mA ~ 2000 mA (24 W max.) or a total of 1 A ~ 3.48 A (41.76 W max.) at +12 V. Connect the fan cable to the fan connector on the motherboard, making sure that the black wire of each cable matches the ground pin of the connector.

The chipset fan connector is for the NVIDIA® nForce™4 SLI chipset. Connect the fan cable to the fan connector on the motherboard.



Do not forget to connect the fan cables to the fan connectors. Insufficient air flow inside the system may damage the motherboard components. These are not jumpers! DO NOT place jumper caps on the fan connectors.

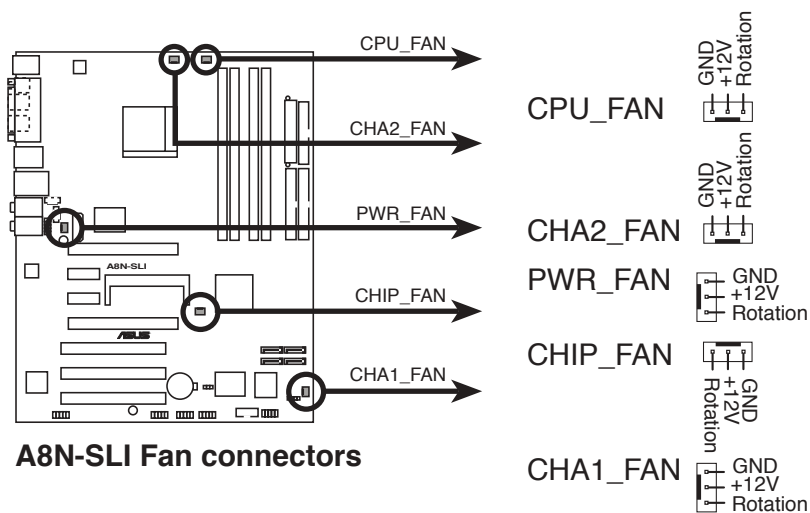

## 6. USB connectors (10-1 pin USB78, USB56, USB910)

These connectors are for USB 2.0 ports. Connect the USB/GAME module cable to any of these connectors, then install the module to a slot opening at the back of the system chassis. These USB connectors comply with USB 2.0 specification that supports up to 480 Mbps connection speed.

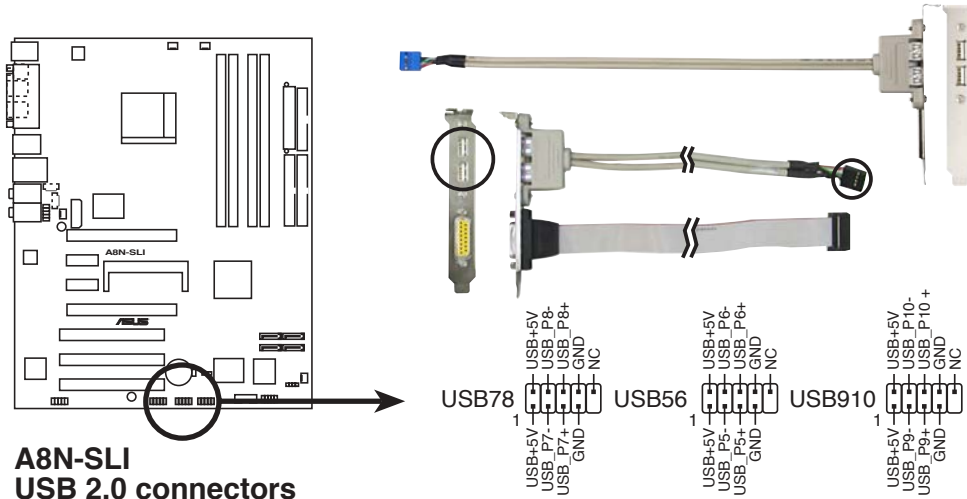

**A8N-SLI  
USB 2.0 connectors**



Never connect a **1394** cable to the USB connectors. Doing so will damage the motherboard!

## 7. IEEE 1394a connector (10-1 pin IE\_1394\_2)

This connector is for an IEEE 1394a port. Connect the IEEE 1394a module cable to this connector, then install the module to a slot opening at the back of the system chassis.

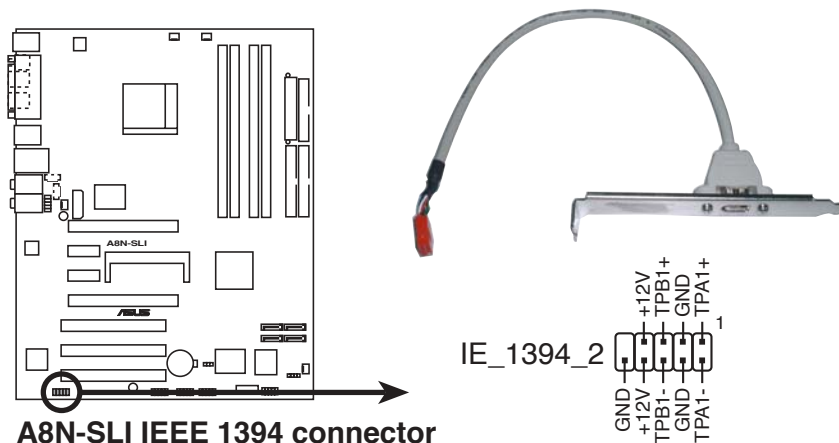

**A8N-SLI IEEE 1394 connector**



NEVER connect a **USB** cable to the IEEE 1394a connector. Doing so will damage the motherboard!

## 8. ATX power connectors (24-pin EATXPWR, 4-pin ATX12V1, 4-pin EZ\_PLUG)

These connectors are for ATX power supply plugs. The power supply plugs are designed to fit these connectors in only one orientation. Find the proper orientation and push down firmly until the connectors completely fit.



- Do not forget to connect the 4-pin ATX +12 V power plug; otherwise, the system will not boot.
- Use of a PSU with a higher power output is recommended when configuring a system with more power-consuming devices. The system may become unstable or may not boot up if the power is inadequate.
- Make sure that your power supply unit (PSU) can provide at least the minimum power required by your system. See the table below for details.

## Power supply requirements

| Components/Peripherals    | Loading           |                   |                   |
|---------------------------|-------------------|-------------------|-------------------|
|                           | Heavy             | Normal            | Light             |
| AMD® K8 939-pin CPU type  | Athlon 64 FX-55   | Athlon 64 3800+   | Athlon 64 3400+   |
| PCIe™ x16 graphics cards  | 6800 Ultra x2     | 6800GT x2         | 6600GT x2         |
| DDR DIMMs                 | 4                 | 2                 | 2                 |
| HDD                       | 4                 | 2                 | 2                 |
| Optical drive (DVD/CD-RW) | 2                 | 2                 | 1                 |
| PCIe™ x 1 card            | 1                 | 0                 | 0                 |
| PCI cards                 | 3                 | 2                 | 1                 |
| IEEE 1394 devices         | 1                 | 0                 | 0                 |
| USB devices               | 6                 | 4                 | 3                 |
| Required +12V current     | <b>&gt; 25A</b>   | <b>&gt; 20A</b>   | <b>&gt; 17A</b>   |
| Required wattage          | <b>&gt;= 500W</b> | <b>&gt;= 400W</b> | <b>&gt;= 350W</b> |

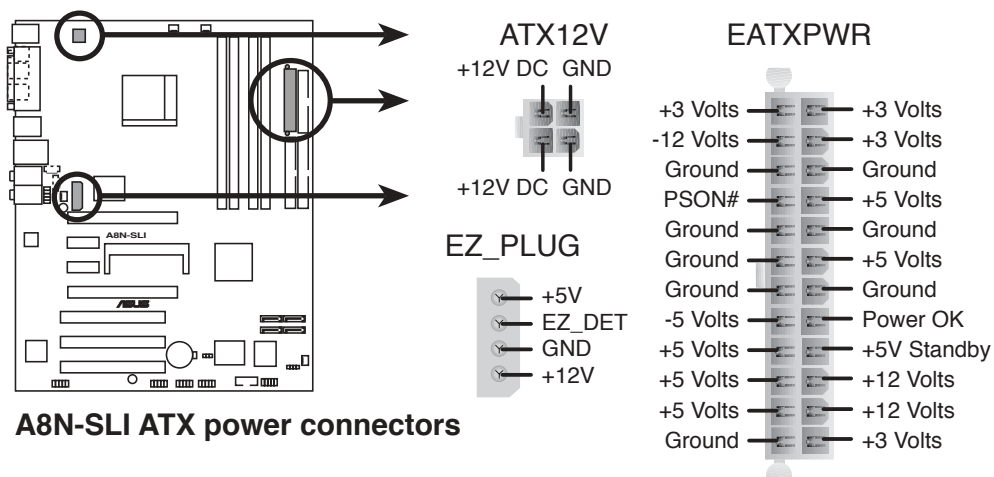

## 9. Internal audio connectors (4-pin AUX, 4-pin CD)

These connectors allow you to receive stereo audio input from sound sources such as a CD-ROM, TV tuner, or MPEG card.

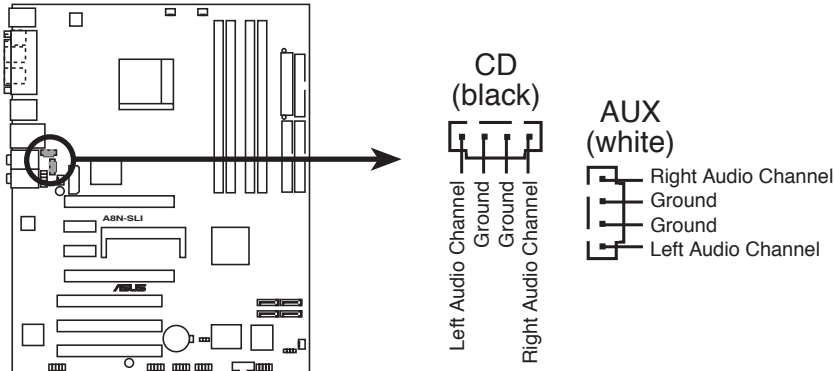

**A8N-SLI Internal audio connectors**

## 10. Front panel audio connector (10-1 pin FP\_AUDIO)

This connector is for a chassis-mounted front panel audio I/O module that supports legacy AC '97 audio standard. Connect one end of the front panel audio I/O module cable to this connector.

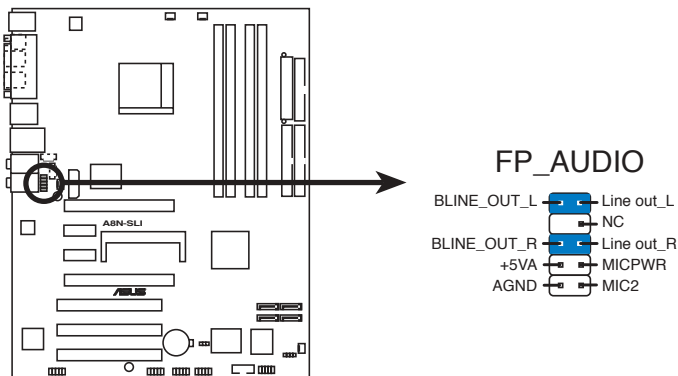

**A8N-SLI Front panel audio connector**

## 11. Chassis intrusion connector (4-1 pin CHASSIS)

This connector is for a chassis-mounted intrusion detection sensor or switch. Connect one end of the chassis intrusion sensor or switch cable to this connector. The chassis intrusion sensor or switch sends a high-level signal to this connector when a chassis component is removed or replaced. The signal is then generated as a chassis intrusion event.

By default, the pins labeled “Chassis Signal” and “Ground” are shorted with a jumper cap. Remove the jumper caps only when you intend to use the chassis intrusion detection feature.

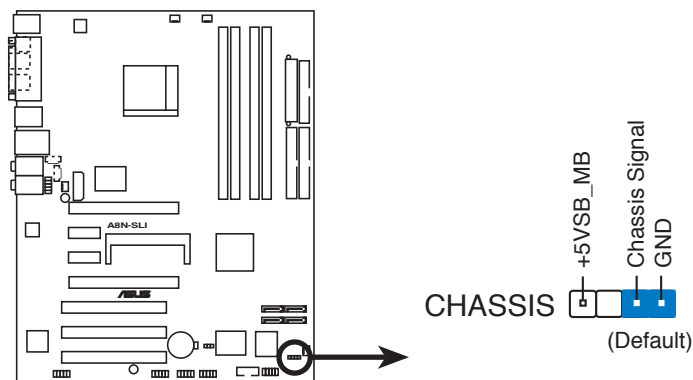

**A8N-SLI Chassis alarm lead**

## 12. System panel connector (10-1 pin F\_PANEL)

This connector supports several chassis-mounted functions.

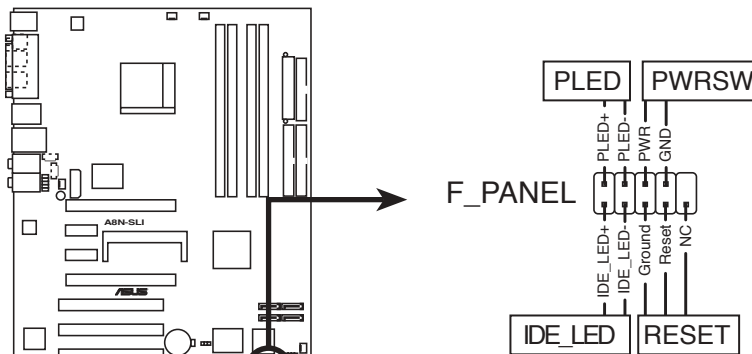

\* Requires an ATX power supply.

**A8N-SLI System panel connector**

- **System power LED (2-pin PLED)**  
This 3-pin connector is for the system power LED. Connect the chassis power LED cable to this connector. The system power LED lights up when you turn on the system power, and blinks when the system is in sleep mode.
- **Hard disk drive activity (2-pin IDE\_LED)**  
This 2-pin connector is for the HDD Activity LED. Connect the HDD Activity LED cable to this connector. The IDE LED lights up or flashes when data is read from or written to the HDD.
- **Power/Soft-off button (2-pin PWRSW)**  
This connector is for the system power button. Pressing the power button turns the system ON or puts the system in SLEEP or SOFT-OFF mode depending on the BIOS settings. Pressing the power switch for more than four seconds while the system is ON turns the system OFF.
- **Reset button (2-pin RESET)**  
This 2-pin connector is for the chassis-mounted reset button for system reboot without turning off the system power.

This chapter tells how to change the system settings through the BIOS Setup menus. Detailed descriptions of the BIOS parameters are also provided.

# BIOS setup

## 2.1 Managing and updating your BIOS

The following utilities allow you to manage and update the motherboard Basic Input/Output System (BIOS) setup.

1. **AwardBIOS Flash Utility** (Updates the BIOS using a floppy disk during POST.)
2. **ASUS CrashFree BIOS 2 Utility** (Updates the BIOS using a bootable floppy disk when the BIOS gets corrupted.)

Refer to the corresponding section for details on these utilities.

### Important notes



- 
- Save a copy of the **original motherboard BIOS file** to a **bootable floppy disk** in case you need to restore the BIOS in the future. Copy the original motherboard BIOS using the ASUS Update or AFLASH utilities.
  - Visit the system builder's website and download the latest BIOS file for this motherboard using the ASUS Update utility.
- 

### 2.1.1 Creating a bootable floppy disk

1. Do either one of the following to create a bootable floppy disk.
  - DOS environment
    - a. Insert a 1.44 MB floppy disk into the drive.
    - b. At the DOS prompt, type `format A: /s` then press <Enter>.
  - Windows® XP environment
    - a. Insert a 1.44 MB floppy disk to the floppy disk drive.
    - b. Click **Start** from the Windows® desktop, then select **My Computer**.
    - c. Select the 3 1/2 Floppy Drive icon.
    - d. Click **File** from the menu, then select **Format**. A **Format 3 1/2 Floppy Disk** window appears.
    - e. Select **Create an MS-DOS startup disk** from the format options field, then click **Start**.

#### Windows® 2000 environment

To create a set of boot disks for Windows® 2000:



- a. Insert a formatted, high density 1.44 MB floppy disk into the drive.
  - b. Insert the Windows® 2000 CD to the optical drive.
  - c. Click **Start**, then select **Run**.
  - d. From the Open field, type  
`D:\bootdisk\makeboot a:`  
assuming that D: is your optical drive.
  - e. Press <Enter>, then follow screen instructions to continue.
2. Copy the original or the latest motherboard BIOS file to the bootable floppy disk.

## 2.1.2 AwardBIOS Flash Utility

The Basic Input/Output System (BIOS) can be updated using the built-in Flash Memory Writer utility or using a bootable floppy disk with the executable Flash Memory Writer Utility (AWDFLASH.EXE). Follow these instructions to update the BIOS using this utility.



---

Save only the updated BIOS file in the floppy disk to avoid loading a wrong BIOS file.

---



---

The succeeding screens are for reference only. The actual displays may not exactly match what you see on your screen.

---

### Updating the BIOS file

1. Download the latest BIOS file from the system builder's website. .  
Rename the file to (BIOS file name on the support CD).BIN and save it to the bootable floppy disk you created earlier.
2. Copy the AwardBIOS Flash Utility (awdfash.exe) from the Software folder of the support CD to the floppy disk with the latest BIOS file.
3. Boot the system in DOS mode using the bootable floppy disk you created earlier.

4. When the **A:>** appears, replace the bootable floppy disk with the floppy disk containing the new BIOS file and the Award BIOS Flash Utility.
5. At the prompt, type **awdflash** then press <Enter>. The Award BIOS Flash Utility screen appears.

```
AwardBIOS Flash Utility for ASUS V1.09
(C) Phoenix Technologies Ltd. All Rights Reserved

For NF-KC804-A8N-SLI-00      DATE: 11/30/2004
Flash Type - SST 49LF004A/B /3.3V

File Name to Program: 
```

Message: Please input File Name!

6. Type the BIOS file name in the **File Name to Program** field, then press <Enter>.

```
AwardBIOS Flash Utility for ASUS V1.09
(C) Phoenix Technologies Ltd. All Rights Reserved

For NF-KC804-A8N-SLI-00      DATE: 11/30/2004
Flash Type - SST 49LF004A/B /3.3V

File Name to Program: 1001-001.bin
```

Message: Do You Want To Save Bios (Y/N)

7. The utility prompts you to save the current BIOS file. Press <Y> to save the current BIOS file to the floppy disk, or <N> to continue.



---

If you intend to save the current BIOS file, make sure that the floppy disk has enough disk space to save the file. See the next section for details on saving the current BIOS file.

---

8. The utility verifies the BIOS file in the floppy disk and starts flashing the BIOS file.

```
AwardBIOS Flash Utility for ASUS V1.09
(C) Phoenix Technologies Ltd. All Rights Reserved
For NF-KC804-A8N-SLI-00      DATE: 11/30/2004
Flash Type - SST 49LF004A/B /3.3V

File Name to Program: 1001-001.bin

Program Flashing Memory - OFE00 OK
████████████████████████████████████████████████████████████████████████████████
████████████████████████████████████████████████████████████████████████████████
████████████████████████████████████████████████████████████████████████████████
Write OK   No Update   Write Fail

Warning: Don't Turn Off Power Or Reset System!
```



---

Do not turn off or reset the system during the flashing process!

---

9. The utility displays a **Flashing Complete** message indicating that you have successfully flashed the BIOS file. Remove the floppy disk then press <F1> to restart the system.

```
AwardBIOS Flash Utility for ASUS V1.09
(C) Phoenix Technologies Ltd. All Rights Reserved
For NF-KC804-A8N-SLI-00      DATE: 11/30/2004
Flash Type - SST 49LF004A/B /3.3V

File Name to Program: 1001-001.bin

Flashing Complete
Press <F1> to Continue

Write OK   No Update   Write Fail

F1 Reset
```

## Saving the current BIOS file

You can use the AwardBIOS Flash Utility to save the current BIOS file. You can load the current BIOS file when the BIOS file gets corrupted during the flashing process.

To save the current BIOS file using the AwardBIOS Flash Utility:

1. Follow steps 1 to 6 of the previous section.

2. Press <Y> when the utility prompts you to save the current BIOS file. The following screen appears.

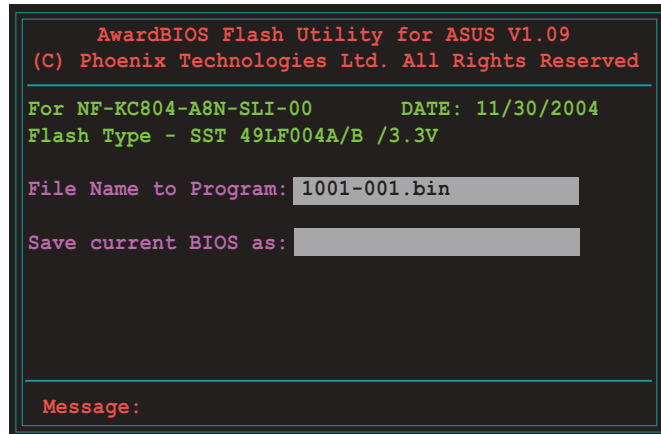

```
AwardBIOS Flash Utility for ASUS V1.09
(C) Phoenix Technologies Ltd. All Rights Reserved

For NF-KC804-A8N-SLI-00      DATE: 11/30/2004
Flash Type - SST 49LF004A/B /3.3V

File Name to Program: 1001-001.bin
Save current BIOS as: _____

Message:
```

3. Type a filename for the current BIOS file in the **Save current BIOS as** field, then press <Enter>.

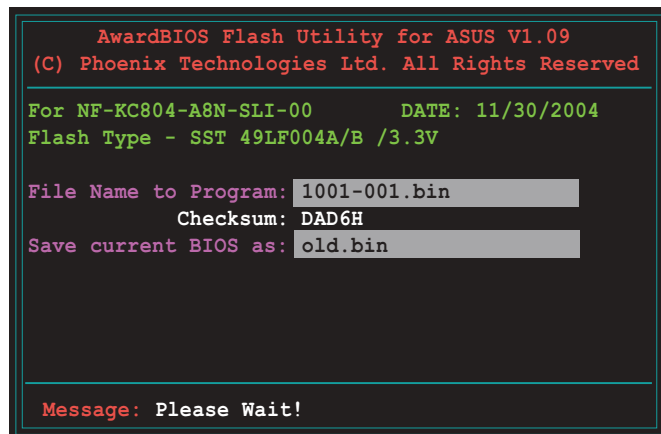

```
AwardBIOS Flash Utility for ASUS V1.09
(C) Phoenix Technologies Ltd. All Rights Reserved

For NF-KC804-A8N-SLI-00      DATE: 11/30/2004
Flash Type - SST 49LF004A/B /3.3V

File Name to Program: 1001-001.bin
Checksum: DAD6H
Save current BIOS as: old.bin

Message: Please Wait!
```

4. The utility saves the current BIOS file to the floppy disk, then returns to the BIOS flashing process.

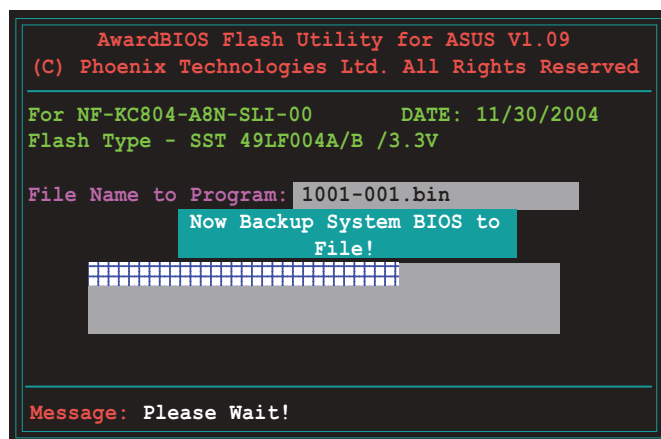

```
AwardBIOS Flash Utility for ASUS V1.09
(C) Phoenix Technologies Ltd. All Rights Reserved

For NF-KC804-A8N-SLI-00      DATE: 11/30/2004
Flash Type - SST 49LF004A/B /3.3V

File Name to Program: 1001-001.bin
Now Backup System BIOS to
File!
_____

Message: Please Wait!
```

## 2.1.3 ASUS CrashFree BIOS 2 utility

The ASUS CrashFree BIOS is an auto recovery tool that allows you to restore the BIOS file when it fails or gets corrupted during the updating process. You can update a corrupted BIOS file using the motherboard support CD or the floppy disk that contains the updated BIOS file.



- Prepare the floppy disk containing the updated motherboard BIOS before using this utility.
- Make sure that you rename the original or updated BIOS file in the floppy disk to **A8N-SLI.ROM**.

### Recovering the BIOS from a floppy disk

To recover the BIOS from a floppy disk:

1. Turn on the system.
2. Insert the floppy disk with the original or updated BIOS file to the floppy disk drive.
3. The utility displays the following message and automatically checks the floppy disk for the original or updated BIOS file.

```
Bad BIOS checksum. Starting BIOS recovery...
Checking for floppy...
```

When found, the utility reads the BIOS file and starts flashing the corrupted BIOS file.

```
Bad BIOS checksum. Starting BIOS recovery...
Checking for floppy...
Floppy found!
Reading file "A8N-SLI.ROM". Completed.
Start flashing...
```



**DO NOT** shut down or reset the system while updating the BIOS! Doing so can cause system boot failure!

4. Restart the system after the utility completes the updating process.

## 2.2 BIOS Setup program

This motherboard supports a programmable Flash ROM that you can update using the provided utility described in section “2.1 Managing and updating your BIOS.”

Use the BIOS Setup program when you are installing a motherboard, reconfiguring your system, or prompted to “Run Setup.” This section explains how to configure your system using this utility.

Even if you are not prompted to use the Setup program, you may want to change the configuration of your computer in the future. For example, you may want to enable the security password feature or make changes to the power management settings. This requires you to reconfigure your system using the BIOS Setup program so that the computer can recognize these changes and record them in the CMOS RAM of the Flash ROM.

The Flash ROM on the motherboard stores the Setup utility. When you start up the computer, the system provides you with the opportunity to run this program. Press <Delete> during the Power-On Self Test (POST) to enter the Setup utility; otherwise, POST continues with its test routines.

To enter Setup after POST, restart the system by pressing <Ctrl> + <Alt> + <Delete>, or by pressing the reset button on the system chassis. You can also restart by turning the system off and then back on. Do this last option only if the first two failed.

The Setup program is designed to make it as easy to use as possible. It is a menu-driven program, which means you can scroll through the various sub-menus and make your selections among the predetermined choices.



---

Because the BIOS software is constantly being updated, the following BIOS setup screens and descriptions are for reference purposes only, and may not exactly match what you see on your screen.

---

## 2.2.1 BIOS menu bar

The top of the screen has a menu bar with the following selections:

|                 |  |
|-----------------|--|
| <b>MAIN</b>     | Use this menu to make changes to the basic system configuration.                                   |
| <b>ADVANCED</b> | Use this menu to enable and make changes to the advanced features.                                 |
| <b>POWER</b>    | Use this menu to configure and enable Power Management features.                                   |
| <b>BOOT</b>     | Use this menu to configure the default system device used to locate and load the Operating System. |
| <b>EXIT</b>     | Use this menu to exit the current menu or to exit the Setup program.                               |

To access the menu bar items, press the right or left arrow key on the keyboard until the desired item is highlighted.

## 2.2.2 Legend bar

At the bottom of the Setup screen is a legend bar. The keys in the legend bar allow you to navigate through the various setup menus. The following table lists the keys found in the legend bar with their corresponding functions.

| Navigation Key(s)        | Function Description   |
|--------------------------|--|
| <F1> or <Alt + H>        | Displays the General Help screen from anywhere in the BIOS Setup   |
| <Esc>                    | Jumps to the Exit menu or returns to the main menu from a sub-menu |
| Left or Right arrow      | Selects the menu item to the left or right                         |
| Up or Down arrow         | Moves the highlight up or down between fields                      |
| - (minus key)            | Scrolls backward through the values for the highlighted field      |
| + (plus key) or spacebar | Scrolls forward through the values for the highlighted field       |
| <Enter>                  | Brings up a selection menu for the highlighted field               |
| <Home> or <PgUp>         | Moves the cursor to the first field                                |
| <End> or <PgDn>          | Moves the cursor to the last field                                 |
| <F5>                     | Resets the current screen to its Setup Defaults                    |
| <F10>                    | Saves changes and exits Setup                                      |

## General help

In addition to the Item Specific Help window, the BIOS setup program also provides a General Help screen. You may launch this screen from any menu by simply pressing <F1>. The General Help screen lists the legend keys and their corresponding functions.

Saving changes and exiting the Setup program

See “2.7 Exit Menu” for detailed information on saving changes and exiting the setup program.

## Scroll bar

When a scroll bar appears to the right of a help window, it indicates that there is more information to be displayed that will not fit in the window. Use <PgUp> and <PgDn> or the up and down arrow keys to scroll through the entire help document. Press <Home> to display the first page, press <End> to go to the last page. To exit the help window, press <Enter> or <Esc>.

## Sub-menu

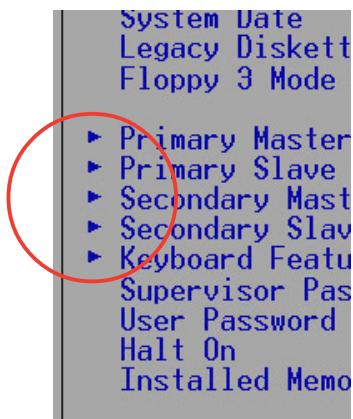

Note that a right pointer symbol (as shown on the left) appears to the left of certain fields. This pointer indicates that you can display a sub-menu from this field. A sub-menu contains additional options for a field parameter. To display a sub-menu, move the highlight to the field and press <Enter>. The sub-menu appears. Use the legend keys to enter values and move from field to field within a sub-menu as you would within a menu. Use the <Esc> key to return to the main menu.

Take some time to familiarize yourself with the legend keys and their corresponding functions. Practice navigating through the various menus and sub-menus. If you accidentally make unwanted changes to any of the fields, use the set default hot key <F5> to load the Setup default values. While moving around through the Setup program, note that explanations appear in the Item Specific Help window located to the right of each menu. This window displays the help text for the currently highlighted field.



## 2.3 Main Menu

When you enter the Setup program, the following screen appears.

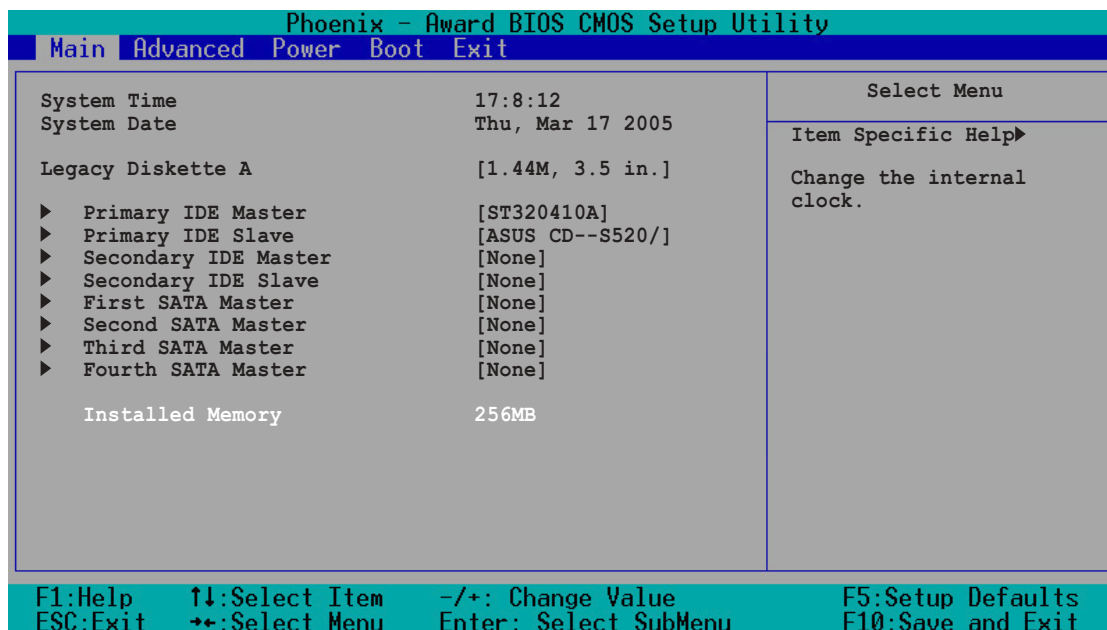

### 2.3.1 System Time [xx:xx:xx]

Sets the system to the time that you specify (usually the current time). The format is hour, minute, second. Valid values for hour, minute and second are Hour: (00 to 23), Minute: (00 to 59), Second: (00 to 59). Use the <Tab> key to move between the hour, minute, and second fields.

### 2.3.2 System Date [xx/xx/xxxx]

Sets the system to the date that you specify (usually the current date). The format is month, day, year. Valid values for month, day, and year are Month: (1 to 12), Day: (1 to 31), Year: (up to 2084). Use the <Tab> key to move between the month, day, and year fields.

### 2.3.3 Legacy Diskette A [1.44M, 3.5 in.]

Sets the type of floppy drive installed. Configuration options: [None] [360K, 5.25 in.] [1.2M , 5.25 in.] [720K , 3.5 in.] [1.44M, 3.5 in.] [2.88M, 3.5 in.]

### 2.3.4 Installed Memory [xxxMB]

This field automatically displays the amount of conventional memory detected by the system during the boot process.

## 2.3.5 Primary and Secondary IDE Master/Slave

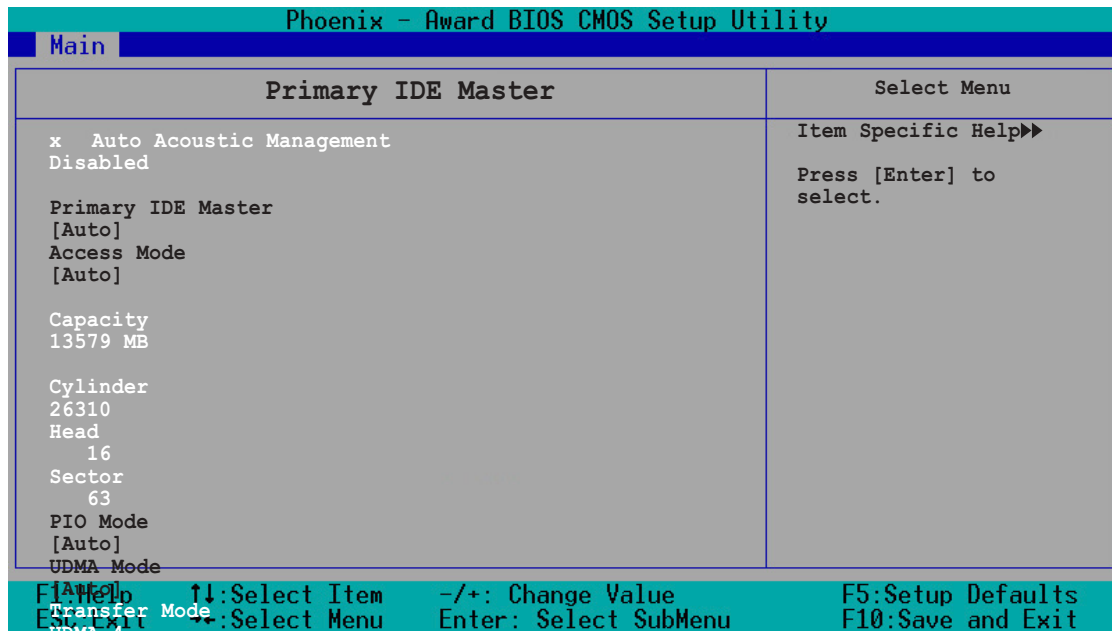

The BIOS automatically detects the values opposite the dimmed items (Capacity, Cylinder, Head, Sector, and Transfer Mode). These values are not user-configurable. These items show N/A if no IDE device is installed in the system.

### Auto Acoustic Management [Disabled]

This option allows drive noise reduction.

Configuration options: [Disabled] [Minimum] [Medium] [Maximum]

### Primary/Secondary IDE Master/Slave [Auto]

Select [Auto] to automatically detect an IDE hard disk drive. If automatic detection is successful, the BIOS automatically fills in the correct values for the remaining fields on this sub-menu. If the hard disk was already formatted on a previous system, the setup BIOS may detect incorrect parameters. Select [Manual] to manually enter the IDE hard disk drive parameters. If no drive is installed select [None].

Configuration options: [None] [Auto] [Manual]

### Access Mode [Auto]

The default [Auto] allows automatic detection of an IDE hard disk drive. Select [CHS] for this item if you set the IDE Primary Master/Slave to [Manual]. Configuration options: [CHS] [LBA] [Large] [Auto]



Before attempting to configure a hard disk drive, make sure you have the correct configuration information supplied by the drive manufacturer. Incorrect settings may cause the system to fail to recognize the installed hard disk.

## Capacity

Displays the auto-detected hard disk capacity. This item is not configurable.

## Cylinder

Shows the number of the hard disk cylinders. This item is not configurable.

## Head

Shows the number of the hard disk read/write heads. This item is not configurable.

## Sector

Shows the number of sectors per track. This item is not configurable.

## PIO Mode

Sets the PIO mode for the IDE device. Configuration options: [Auto] [Mode 0] [Mode 1] [Mode 2] [Mode 3] [Mode 4]

## UDMA Mode

Disables or sets the UDMA mode. Configuration options: [Disabled] [Auto]

## Transfer Mode

Shows the Transfer mode. This item is not configurable.



---

After entering the IDE hard disk drive information into BIOS, use a disk utility, such as FDISK, to partition and format new IDE hard disk drives. This is necessary so that you can write or read data from the hard disk. Make sure to set the partition of the Primary IDE hard disk drives to active.

---

## 2.3.6 First, Second, Third, and Fourth SATA Master

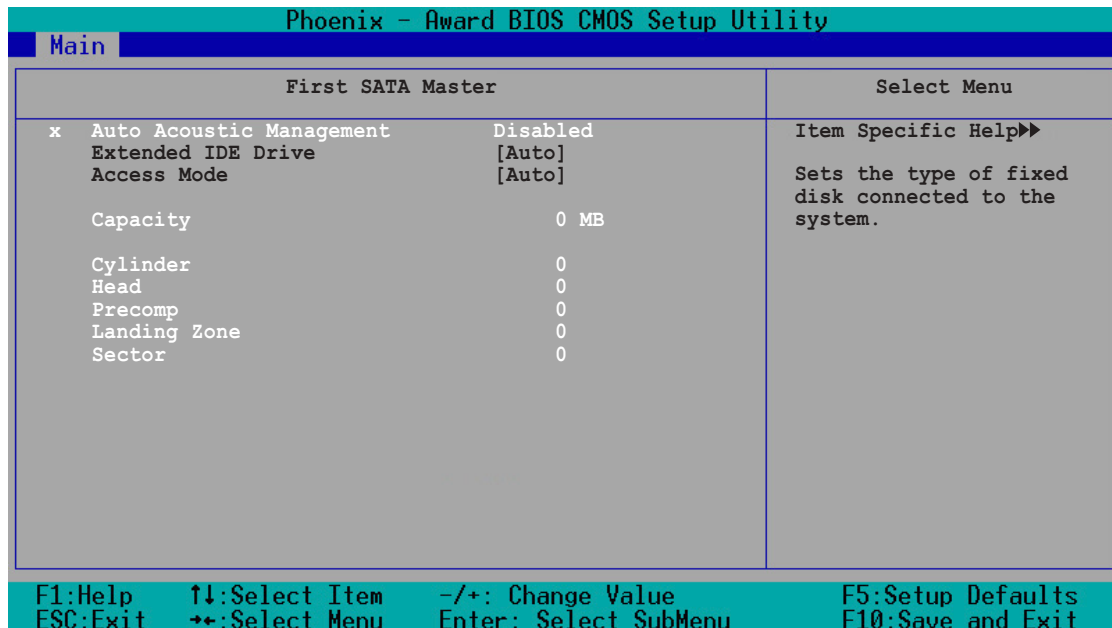

The BIOS automatically detects the values opposite the dimmed items (Capacity, Cylinder, Head, Precomp, Landing Zone and Sector). These values are not user-configurable. These items show 0 if no SATA device is installed in the system.

### Extended IDE Drive [Auto]

Select [Auto] to automatically detect a SATA hard disk drive. If automatic detection is successful, Setup automatically fills in the correct values for the remaining fields on this sub-menu. Configuration options: [None] [Auto]

### Access Mode [Auto]

Allows the user to select the sector addressing mode. Refer to the previous page for detailed descriptions of the different modes. Configuration options: [Large] [Auto]



Before attempting to configure a hard disk drive, make sure you have the correct configuration information supplied by the drive manufacturer. Incorrect settings may cause the system to fail to recognize the installed hard disk.

## Capacity

Displays the auto-detected hard disk capacity. This item is not configurable.

## Cylinder

Shows the number of the hard disk cylinders. This item is not configurable.

## Head

Shows the number of the hard disk read/write heads. This item is not configurable.

## Precomp

Shows the number of precomp per track. This item is not configurable.

## Landing Zone

Shows the number of landing zone per track. This item is not configurable.

## Sector

Shows the number of sectors per track. This item is not configurable.



---

After entering the IDE hard disk drive information into BIOS, use a disk utility, such as FDISK, to partition and format new IDE hard disk drives. This is necessary so that you can write or read data from the hard disk. Make sure to set the partition of the Primary IDE hard disk drives to active.

---

## 2.3.7 Installed Memory

Shows the size of installed memory.

## 2.4 Advanced Menu

The Advanced menu items allow you to change the settings for the CPU and other system devices.



Take caution when changing the settings of the Advanced menu items. Incorrect field values may cause the system to malfunction.

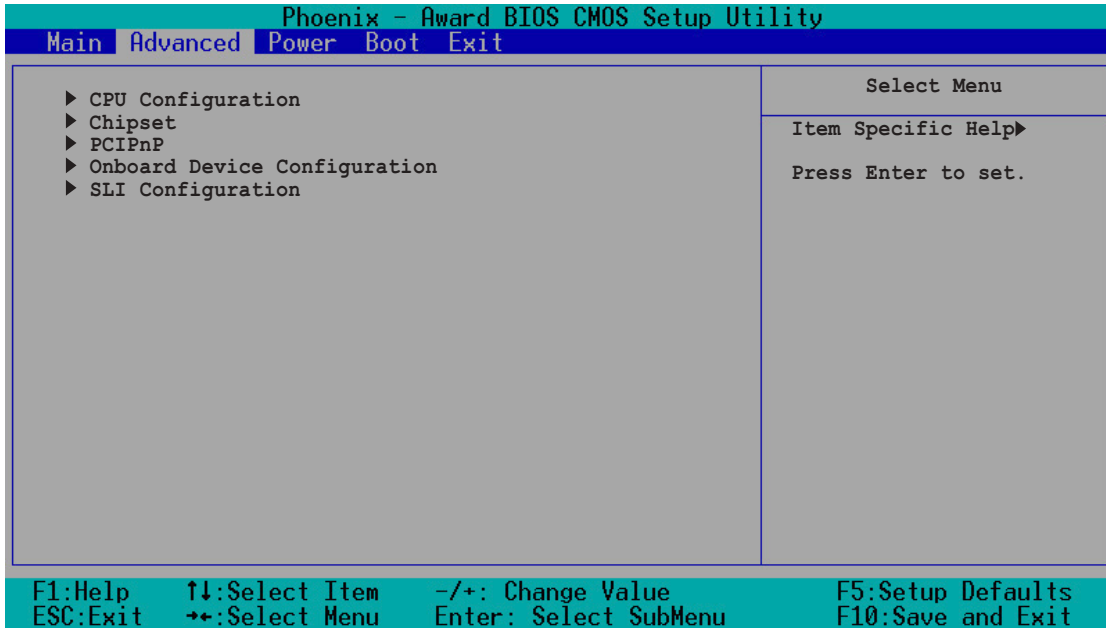

## 2.4.1 CPU configuration

The items in this menu show the CPU-related information auto-detected by the BIOS.

| Phoenix - Award BIOS CMOS Setup Utility              |                        |
|--|------------------------|
| Advanced   |                        |
| CPU Configuration                                    | Select Menu            |
| CPU Type           AMD Athlon(tm) 64 Processor 3400+ | Item Specific Help▶▶   |
| CPU Speed         2200MHz                            |                        |
| Cache RAM         512K                               | Enable/Disable         |
| AMD K8 Cool `n` Quiet control           [Enabled]    | Cool`n`Quiet function. |

F1:Help   ↑↓:Select Item   -/+ : Change Value   F5:Setup Defaults  
ESC:Exit   →←:Select Menu   Enter: Select SubMenu   F10:Save and Exit

### AMD K8 Cool `n` Quiet control [Enabled]

Enables or disables the AMD K8 Cool `n` Quiet™ feature.  
Configuration options: [Enabled] ~ [Disabled]

## 2.4.2 Chipset configuration

The items in this menu show the chipset configuration settings. Select an item then press <Enter> to display a pop-up menu with the configuration options.

| Phoenix - Award BIOS CMOS Setup Utility |                    |                   |                          |
|---|--------------------|-------------------|--------------------------|
| Advanced                                |                    |                   |                          |
| Chipset                                 |                    | Select Menu       |                          |
| ▶                                       | DRAM Configuration | [Press Enter]     | Item Specific Help▶▶     |
|   | Errata 94 Enhanced | [Enabled]         | DRAM timing and control. |
| F1:Help                                 |                    | ↑↓:Select Item    | -/+ : Change Value       |
| ESC:Exit                                |                    | +<:Select Menu    | Enter: Select SubMenu    |
|   |                    | F5:Setup Defaults | F10:Save and Exit        |

## DRAM Configuration

The items in this sub-menu show the DRAM-related information that the BIOS auto-detects.

| Phoenix - Award BIOS CMOS Setup Utility |                             |                   |   |
|---|-----------------------------|-------------------|---|
| Advanced                                |                             |                   |   |
| DRAM Configuration                      |                             | Select Menu       |   |
|   | Timing Mode                 |                   | Item Specific Help▶▶  |
|   | [Auto]                      |                   | <Enter> to select DRAM configuration. [Auto] is recommended. [Manual] allows you to set each configuration on your own. |
| x                                       | Memclock index value (Mhz)  | 200Mhz            |   |
| x                                       | CAS# Latency (Tcl)          | 2.5               |   |
| x                                       | Min RAS# active time (Tras) | 8T                |   |
| x                                       | RAS# to CAS# delay (Trcd)   | 4T                |   |
| x                                       | Row precharge time (Trp)    | 2T                |   |
| x                                       | 1/T/2T Memory Timing        | 2T                |   |
|   | Bottom of 32-bit [31:24] IO | [E0]              |   |
|   | DRAM Over 4G Remapping      |                   |   |
|   | [Disabled]                  |                   |   |
|   | MTRR mapping mode           |                   |   |
|   | [Continuous]                |                   |   |
| F1:Help                                 |                             | ↑↓:Select Item    | -/+ : Change Value  |
| ESC:Exit                                |                             | +<:Select Menu    | Enter: Select SubMenu   |
|   |                             | F5:Setup Defaults | F10:Save and Exit   |



Timing Mode [Auto]

Sets the timing mode. Configuration options: [Auto] [Manual]

Memclock index value [200Mhz]

Sets the DRAM frequency.

Configuration options: [100Mhz] [133Mhz] [166Mhz] [200Mhz]

CAS# latency (Tcl) [2.5]

Sets the CAS# latency.

Configuration options: [2] [2.5] [3]

Min RAS# active time (Tras) [8T]

Sets the minimum RAS# active time.

Configuration options: [5T] ~ [15T]

RAS# to CAS# delay (Trcd) [4T]

Sets the RAS# to CAS# delay to Read/Write command on the same bank. Configuration options: [2T] ~ [7T]

Row precharge Time (Trp) [2T]

Sets the Row precharge time.

Configuration options: [2T] ~ [7T]

1T/2T Memory Timing [2T]

Sets the memory timing. Configuration options: [1T] [2T]



---

The above items become configurable when the **Timing Mode** item is set to [Manual]

---

Bottom of 32-bit [31:24] IO [E0]

Allows you to see the minimum and maximum limits of the 32-bit memory-mapped IO location.

DRAM Over 4G Remapping [Disabled]

Enables or disables DRAM remapping when using 4 GB of system memory. Configuration options: [Disabled] [Enabled]

### MTRR mapping mode [Continuous]

Sets the MTRR mapping mode.

Configuration options: [Continuous] [Discrete]

## **Errata 94 Enhanced [Auto]**

Configuration options: [Auto] [Disabled]

## **2.4.3 PCIPnP**

The items in this menu show the PCIPnP configuration settings. Select an item then press <Enter> to display a pop-up menu with the configuration options.

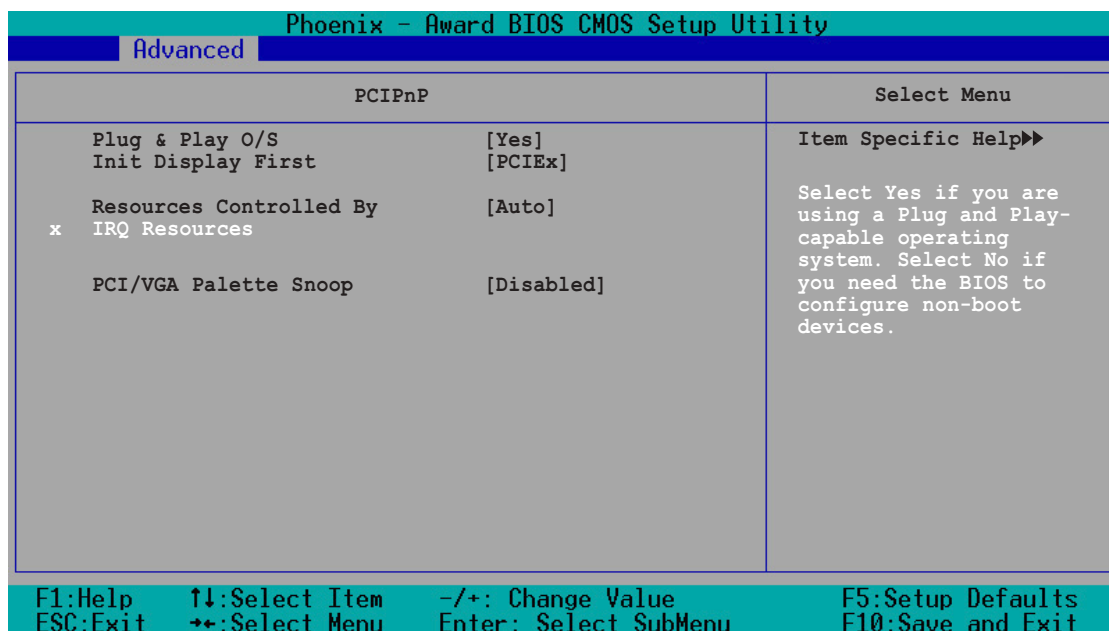

### **Plug & Play OS [Yes]**

Select [Yes] if you are using a Plug and Play capable operating system.

Select [No] if you need the BIOS to configure non-boot devices.

Configuration options: [No] [Yes]

### **Init Display First [PCIEx]**

Allows you to select which graphics controller to use as the primary boot device. Configuration options: [PCI slot] [PCIEx]

### **Resources Controlled By [Auto]**

When set to [Auto(ESCD)], this allows the BIOS to automatically configure all the boot and Plug and Play devices. When set to [Manual], you can assign the available IRQ resources to the PCI devices.

Configuration options: [Auto] [Manual]



When the item Resources Controlled By is set to [Auto], the item IRQ Resources is grayed out and is not configurable. Refer to the section “IRQ Resources” for information on how to enable this item.

## IRQ Resources

This sub-menu is activated only when the **Resources Controlled By** item is set to Manual.

| Phoenix - Award BIOS CMOS Setup Utility |                |                        |                   |
|---|----------------|------------------------|-------------------|
| Advanced                                |                |                        |                   |
| IRQ Resources                           |                | Select Menu            |                   |
| IRQ-3 assigned to                       | [PCI Device]   | Item Specific Help▶▶▶  |                   |
| IRQ-4 assigned to                       | [PCI Device]   | Legacy ISA for devices |                   |
| IRQ-5 assigned to                       | [PCI Device]   | compliant with the     |                   |
| IRQ-7 assigned to                       | [PCI Device]   | original PC AT bus     |                   |
| IRQ-9 assigned to                       | [PCI Device]   | specification, PCI ISA |                   |
| IRQ-10 assigned to                      | [PCI Device]   | PnP for devices        |                   |
| IRQ-11 assigned to                      | [PCI Device]   | compliant with the     |                   |
| IRQ-12 assigned to                      | [PCI Device]   | Plug and Play standard |                   |
| IRQ-14 assigned to                      | [PCI Device]   | whether designed for   |                   |
| IRQ-15 assigned to                      | [PCI Device]   | PCI or ISA bus         |                   |
|   |                | architecture.          |                   |
| F1:Help                                 | ↑↓:Select Item | -/+: Change Value      | F5:Setup Defaults |
| ESC:Exit                                | →+:Select Menu | Enter: Select SubMenu  | F10:Save and Exit |

### IRQ-xx assigned to

When set to [PCI Device], the specific IRQ is free for use of PCI/PnP devices. When set to [Reserved], the IRQ is reserved for legacy ISA devices. Configuration options: [PCI Device] [Reserved]

## PCI/VGA Palette Snoop [Disabled]

Some non-standard VGA cards, like graphics accelerators or MPEG video cards, may not show colors properly. Setting this field to [Enabled] corrects this problem. If you are using standard VGA cards, leave this field to the default setting [Disabled]. Configuration options: [Disabled] [Enabled]

## 2.4.4 Onboard device configuration

The items in this menu show the onboard device configuration settings. Select an item then press <Enter> to display a pop-up menu with the configuration options.

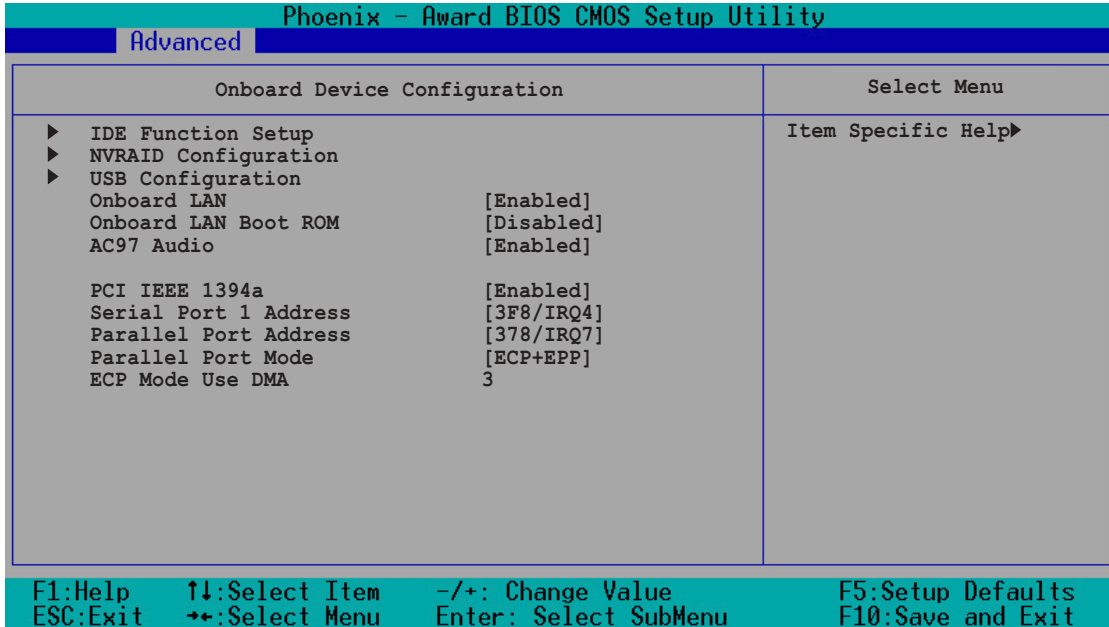

## IDE Function Setup

This sub-menu contains IDE function-related items. Select an item then press <Enter> to edit.

| Phoenix - Award BIOS CMOS Setup Utility  |                                    |
|--|------------------------------------|
| Advanced   |                                    |
| IDE Function Setup   | Select Menu                        |
| OnChip Channel0 [Enabled]  | Item Specific Help▶▶▶              |
| OnChip IDE Channel1 [Enabled]  | Disable/Enable OnChip IDE Channel0 |
| IDE DMA transfer access [Enabled]  |                                    |
| Serial-ATA 1 [Enabled]   |                                    |
| SATA DMA transfer [Enabled]  |                                    |
| Serial-ATA 2 [Enabled]   |                                    |
| SATA2 DMA transfer [Enabled]   |                                    |
| IDE Prefetch Mode [Enabled]  |                                    |
| F1:Help    ↑↓:Select Item    -/+ : Change Value    F5:Setup Defaults<br>ESC:Exit    →+:Select Menu    Enter: Select SubMenu    F10:Save and Exit |                                    |

### OnChip IDE Channel0 [Enabled]

Allows you to enable or disable the onchip IDE channel 0 controller .  
Configuration options: [Disabled] [Enabled]

### OnChip IDE Channel1 [Enabled]

Allows you to enable or disable the onchip IDE channel 1 controller .  
Configuration options: [Disabled] [Enabled]

### IDE DMA transfer access [Enabled]

Allows you to enable or disable the IDE DMA transfer access.  
Configuration options: [Disabled] [Enabled]

### Serial-ATA 1 [Enabled]

Allows you to enable or disable the Serial ATA 1 port.  
Configuration options: [Disabled] [Enabled]

### SATA DMA transfer [Enabled]

Allows you to enable or disable the SATA DMA transfer access.  
Configuration options: [Disabled] [Enabled]

Serial-ATA 2 [Enabled]

Allows you to enable or disable the Serial ATA 2 port.  
Configuration options: [Disabled] [Enabled]

SATA2 DMA transfer [Enabled]

Allows you to enable or disable the SATA2 DMA transfer access.  
Configuration options: [Disabled] [Enabled]

IDE Prefetch Mode [Enabled]

Allows you to enable or disable the IDE prefetch mode.  
Configuration options: [Disabled] [Enabled]

## NVRAID Configuration

This sub-menu contains NVRAID function-related items. Select an item then press <Enter> to edit.

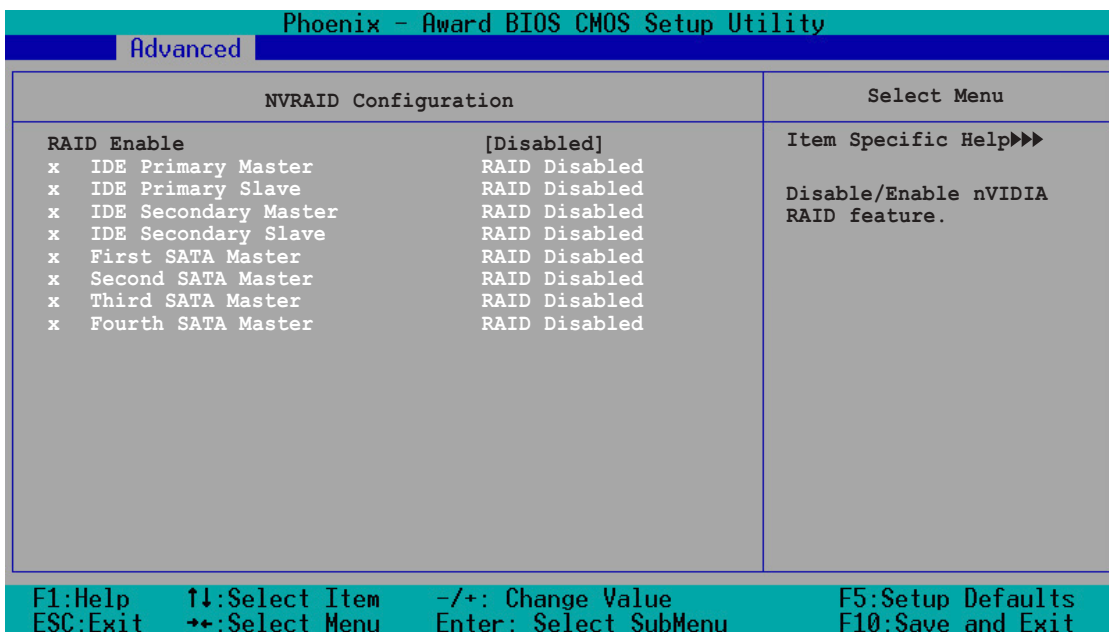

RAID Enable [Disabled]

Enables or disables the onboard RAID controller. When Enabled, the succeeding items become user-configurable.  
Configuration options: [Enabled] [Disabled]

IDE Primary and Secondary Master/Slave RAID [Disabled]

Enables or disables the RAID function of the primary or secondary master or slave IDE. Configuration options: [Enabled] [Disabled]

First, Second, Third, Fourth SATA Master RAID [Disabled]

Enables or disables the RAID function of the first, second, third or fourth SATA master drive. Configuration options: [Enabled] [Disabled]

## USB configuration

The items in this menu show the USB configuration settings. Select an item then press <Enter> to display a pop-up menu with the configuration options.

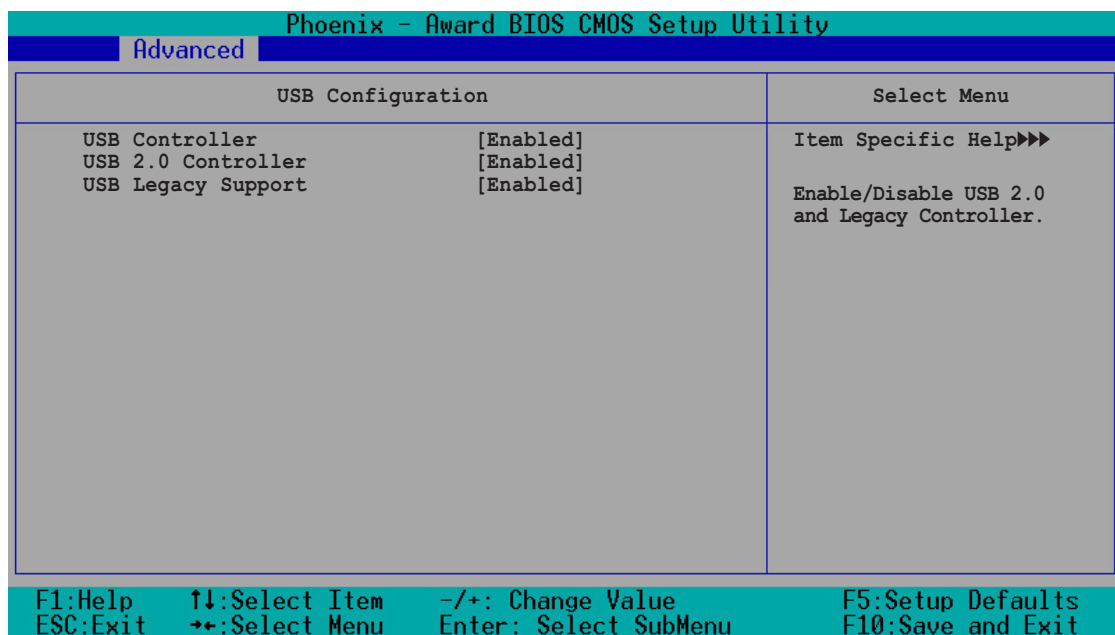

### USB Controller [Enabled]

Allows you to enable or disable the onchip USB controller. Configuration options: [Disabled] [Enabled]

### USB 2.0 Controller [Enabled]

Allows you to enable or disable the USB 2.0 controller. Configuration options: [Disabled] [Enabled]

### USB Legacy Support [Enabled]

Allows you to enable or disable support for USB devices on legacy operating systems (OS). Configuration options: [Disabled] [Enabled]

### **Onboard LAN [Enabled]**

Allows you to enable or disable the onboard LAN controller. Keep the default [Enabled] if you wish to use the onboard LAN feature. Set to [Disabled] if you installed a PCI LAN card. Configuration options: [Disabled] [Enabled]

### **Onboard LAN Boot ROM [Disabled]**

Setting to [Enabled] allowed the BIOS to invoke the boot ROM of the onboard LAN chip. Configuration options: [Enabled] [Disabled]

### **AC97 Audio [Enabled]**

Allows you to enable or disable the onboard AC`97 Audio controller. Configuration options: [Disabled] [Enabled]

### **PCI IEEE 1394a [Enabled]**

Allows you to enable or disable the onboard IEEE 1394a device support. Configuration options: [Disabled] [Enabled]

### **Serial Port1 Address [3F8/IRQ4]**

Allows you to set the addresses for the onboard serial port connector. Configuration options: [Disabled] [3F8/IRQ4] [2F8/IRQ3] [3E8/IRQ4] [2E8/IRQ3]

### **Parallel Port Address [378/IRQ7]**

Allows you to set the base address of the onboard parallel port connector. If you disable this field, the Parallel Port Mode and ECP DMA Select configurations are not available. Configuration options: [Disabled] [378/IRQ7] [278/IRQ5] [3BC/IRQ7]

### **Parallel Port Mode [ECP+EPP]**

Allows you to set the operation mode of the parallel port. Configuration options: [SPP] [EPP] [ECP] [ECP+EPP]

### **ECP Mode Use DMA [3]**

Allows you to select the ECP Mode. This item becomes configurable only if the **Parallel Port Mode** is set to [ECP] or [ECP+EPP]. Configuration options: [1] [3]



## SLI configuration

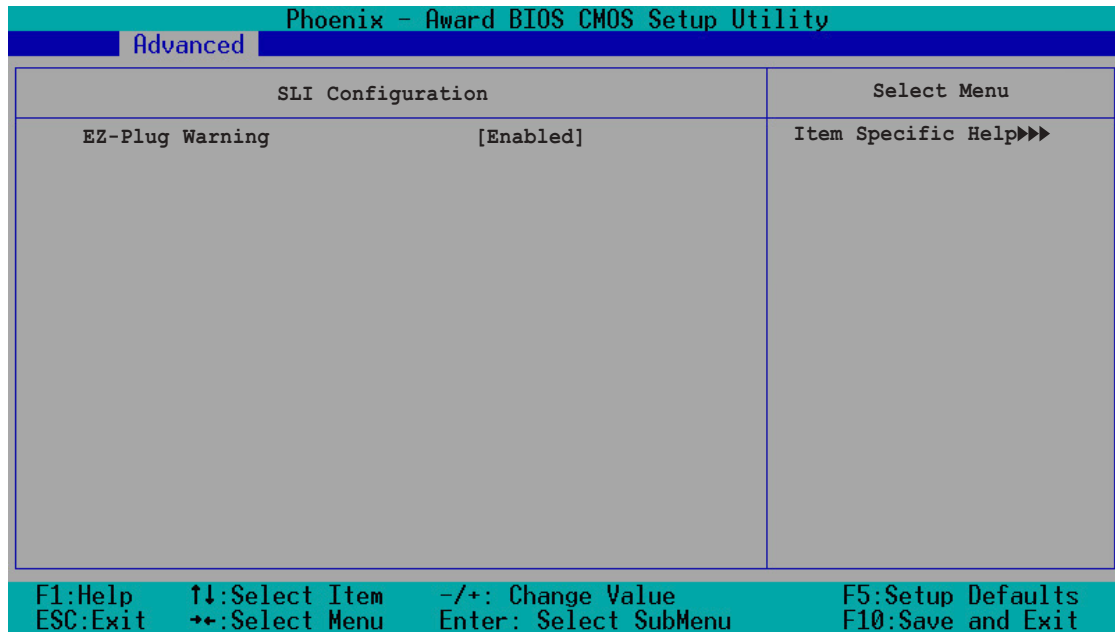

### EZ-Plug Warning [Enabled]

Allows you to enable or disable the EZ-Plug warning feature.  
Configuration options: [Disabled] [Enabled]

## 2.5 Power Menu

The Power menu allows you to reduce power consumption. This feature turns off the video display and shuts down the hard disk after a period of inactivity.

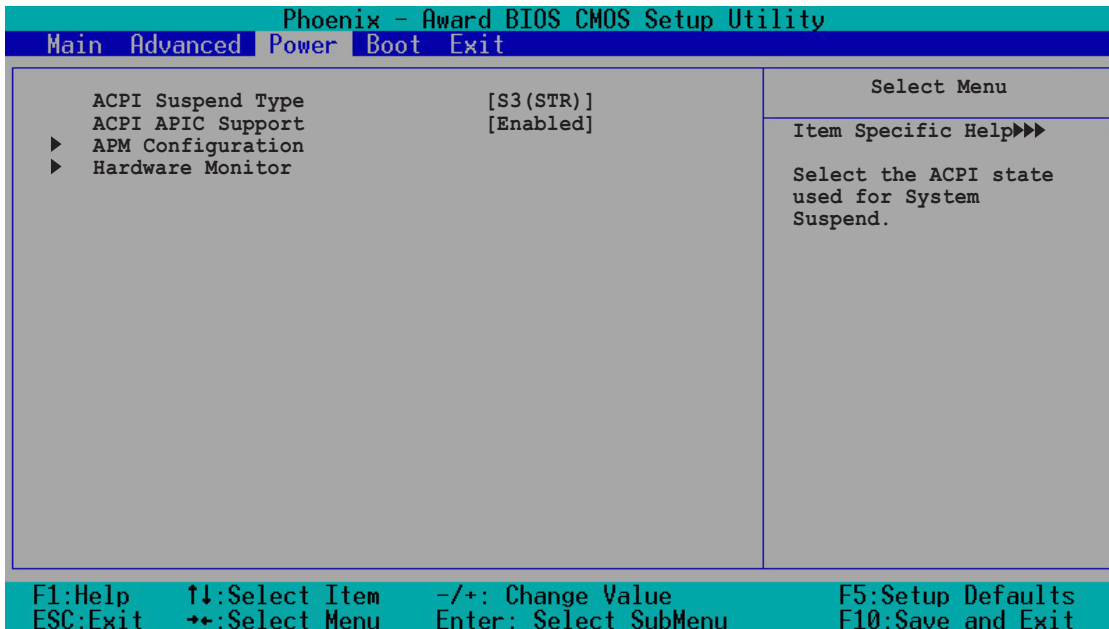

### ACPI Suspend Type [S3(STR)]

Allows you to select the ACPI state used for system suspend.  
Configuration options: [S1(POS)] [S3(STR)] [S1&S3]

### ACPI APIC Support [Enabled]

Allows you to enable or disable the Advanced Configuration and Power Interface (ACPI) support in the Advanced Programmable Interrupt Controller (APIC). When set to Enabled, the ACPI APIC table pointer is included in the RSDT pointer list. Configuration options: [Disabled] [Enabled]

## 2.5.1 APM configuration

This menu shows the Advanced Power Management (APM) configuration settings. Select an item then press <Enter> to display a pop-up menu with the configuration options.

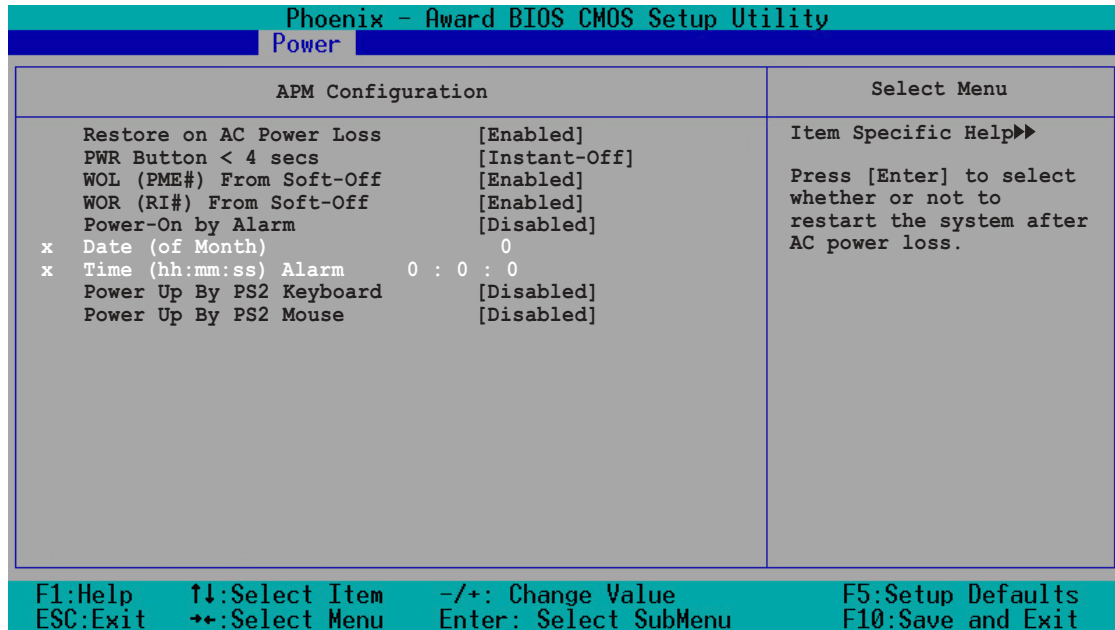

### Restore on AC Power Loss [Enabled]

Allows you to set whether or not to reboot the system after power interruptions. [Disabled] leaves your system off while [Enabled] reboots the system. Configuration options: [Disabled] [Enabled]

### PWR Button < 4 secs [Instant-Off]

Allows you to set the event after the power button is pressed for more than 4 seconds. Configuration options: [Suspend] [Instant-Off]

### WOL (PME#) From Soft-Off [Enabled]

Allows you to enable or disable the Wake-On-LAN feature. This feature requires an ATX power supply that provides at least 1A on the +5VSB lead. Configuration options: [Disabled] [Enabled]

### WOR (RI#) From Soft-Off [Enabled]

Allows you to enable or disable the Wake-On-Ring feature. This feature requires an ATX power supply that provides at least 1A on the +5VSB lead. Configuration options: [Disabled] [Enabled]

## Power-On By Alarm [Disabled]

Allows you to enable or disable RTC to generate a wake event. When this item is set to Enabled, the items Date of Month Alarm and Time (hh:mm:ss) Alarm items become user-configurable with set values.

Configuration options: [Disabled] [Enabled]



---

The two succeeding items become configurable only when the **Power-On By RTC Alarm** item is set to [Enabled].

---

## Day of Month Alarm [0]

To set the date of alarm, highlight this item and press <Enter> to display the Day of Month Alarm pop-up menu. Key-in a value within the specified range then press <Enter>. A [0] value means everyday. Configuration options: [Min=0] [Max=31]

## Time (hh:mm:ss) Alarm [0:0:0]

To set the time of alarm:

1. Highlight this item and press <Enter> to display a pop-up menu for the hour field.
2. Key-in a value (Min=0, Max=23), then press <Enter>.
3. Press <TAB> to move to the minutes field then press <Enter>.
4. Key-in a minute value (Min=0, Max=59), then press <Enter>.
5. Press <TAB> to move to the seconds field then press <Enter>.
6. Key-in a value (Min=0, Max=59), then press <Enter>.

## Power Up By PS2 Keyboard [Disabled]

Allows you to disable the Power On by PS/2 keyboard function or set specific keys on the PS/2 keyboard to turn on the system. This feature requires an ATX power supply that provides at least 1A on the +5VSB lead. Configuration options: [Disabled] [Enabled]

## Power Up By PS2 Mouse [Disabled]

When set to [Enabled], this parameter allows you to use the PS/2 mouse to turn on the system. This feature requires an ATX power supply that provides at least 1A on the +5VSB lead. Configuration options: [Disabled] [Enabled]

## 2.5.2 Hardware monitor

This menu shows the hardware monitor settings auto-detected by the BIOS.

| Phoenix - Award BIOS CMOS Setup Utility |                                     |
|---|-------------------------------------|
| Power                                   |                                     |
| Hardware Monitor                        | Select Menu                         |
| Q-Fan Controller [Enabled]              | Item Specific Help▶▶                |
| Vcore Voltage 1.50V                     | Press [Enter] to enable or disable. |
| 3.3V Voltage 3.31V                      |                                     |
| 5V Voltage 4.94V                        |                                     |
| 12V Voltage 11.26V                      |                                     |
| CPU Temperature 48°C                    |                                     |
| M/B Temperature 38°C                    |                                     |
| CPU FAN Speed 4962 RPM                  |                                     |
| CHA1 FAN Speed 0 RPM                    |                                     |
| CPU Target Temperature [66°C]           |                                     |

F1:Help    ↑↓:Select Item    -/+ : Change Value    F5:Setup Defaults  
ESC:Exit    →+:Select Menu    Enter: Select SubMenu    F10:Save and Exit

### Q-Fan Controller [Enabled]

Allows you to enable or disable the Q-Fan controller.  
Configuration options: [Disabled] [Enabled]

### VCORE Voltage, +12V Voltage, 3.3V Voltage, 5VCC Voltage

The onboard hardware monitor automatically detects the voltage output through the onboard voltage regulators. These items are not user-configurable.

### CPU Temperature, M/B Temperature

The onboard hardware monitor automatically detects and displays the motherboard and CPU temperatures. These items are not user-configurable.

### CPU Fan Speed/CHA1 Fan Speed

The onboard hardware monitor automatically detects and displays the Chassis, CPU, and Chip fan speeds in rotations per minute (RPM). If the fan is not connected to the motherboard, the field shows 0. These items are not user-configurable.

## CPU Target Temperature [66°C]

Allows you to set the CPU temperature threshold. When the CPU temperature reaches the value you set, the CPU fan runs at full speed.  
Configuration options: [51°C] [54°C] [57°C] [60°C] [63°C] [66°C] [69°C] [72°C] [75°C] [78°C] [81°C]



This item becomes configurable only when the **Q-Fan Controller** item is set to [Enabled].

## 2.6 Boot Menu

This Boot menu items allow you to change the system boot settings. Select an item then press <Enter> to display a pop-up menu with the configuration options.

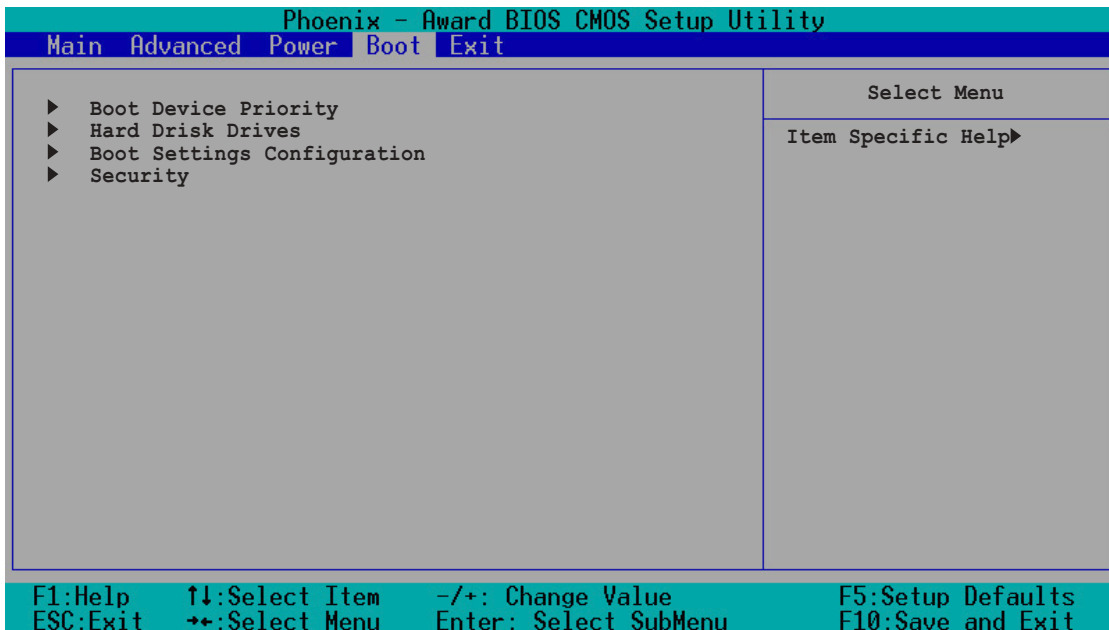

## 2.6.1 Boot Device Priority

| Phoenix - Award BIOS CMOS Setup Utility   |             |  |
|---|-------------|--|
| Boot  |             |  |
| Boot Device Priority  |             | Select Menu  |
| 1st Boot Device   | [CDROM]     | Item Specific Help▶<br><br>Select your boot device priority. |
| 2nd Boot Device   | [Removable] |  |
| 3rd Boot Device   | [Hard Disk] |  |
| 4th Boot Device   | [Disabled]  |  |
| F1:Help    ↑↓:Select Item    -/+: Change Value    F5:Setup Defaults<br>ESC:Exit    →←:Select Menu    Enter: Select SubMenu    F10:Save and Exit |             |  |

### 1st ~ xth Boot Device

These items specify the boot device priority sequence from the available devices. The number of devices that appears on the screen depends on the number of devices installed in the system. Configuration options:  
 [Removable] [Hard Disk] [CDROM] [Legacy LAN] [Disabled]

## 2.6.2 Hard Disk Drives

| Phoenix - Award BIOS CMOS Setup Utility   |  |  |
|---|--|--|
| Boot  |  |  |
| Hard Disk Drives  |  | Select Menu  |
| 1. 1st Master: ST320410A<br>2. Bootable Add-in Cards  |  | Item Specific Help▶▶<br><br>Use <up> or <down> arrow to select a device, then press <+> to move it up, or <-> to move it down the list. Press <ESC> to exit this menu. |
|   |  |  |
| F1:Help    ↑↓:Select Item    -/+: Change Value    F5:Setup Defaults<br>ESC:Exit    →←:Select Menu    Enter: Select SubMenu    F10:Save and Exit |  |  |

## 2.6.3 Boot settings configuration

| Phoenix - Award BIOS CMOS Setup Utility |             |
|---|-------------|
| Boot                                    |             |
| Boot Settings Configuration             | Select Menu |
| Case Open Warning                       | [Disabled]  |
| Quick Boot                              | [Enabled]   |
| Boot Up Floppy Seek                     | [Enabled]   |
| Bootup Num-Lock                         | [On]        |
| OS Select for DRAM > 64MB               | [Non-OS2]   |
| Full Screen Logo                        | [Enabled]   |
| Halt On                                 | [No Errors] |

Item Specific Help▶  
Press [Enter] to enable or disable.

F1:Help    ↑↓:Select Item    -/+ : Change Value    F5:Setup Defaults  
ESC:Exit    →+:Select Menu    Enter: Select SubMenu    F10:Save and Exit

### Case Open Warning [Enabled]

Enables or disables the chassis open status feature. Setting to Enabled, clears the chassis open status. Refer to section “2.7 Internal connectors” for setting details. Configuration options: [Disabled] [Enabled]

### Quick Boot [Enabled]

Setting to [Enabled] allows the system to skip certain tests while booting, decreasing the time needed to boot the system.

Configuration options: [Disabled] [Enabled]

### Boot Up Floppy Seek [Enabled]

When [Enabled], the BIOS will seek the floppy disk drive to determine whether the drive has 40 or 80 tracks. Configuration options: [Disabled] [Enabled]

### Bootup Num-Lock [On]

Allows you to select the power-on state for the NumLock.

Configuration options: [Off] [On]

### OS Select for DRAM > 64MB [Non-OS2]

Select [OS2] only when you are using an OS2 operating system with greater than 64MB RAM; otherwise, set to [Non-OS2].

Configuration options: [Non-OS2] [OS2]



## Full Screen Logo [Enabled]

Allows you to enable or disable the full screen logo display feature.  
Configuration options: [Disabled] [Enabled]



---

Set this item to [Enabled] to use the ASUS MyLogo™ feature.

---

## Halt On [No Errors]

Sets the system to halt on errors according to the system functions specified in each option. Configuration options: [All Errors] [No Errors] [All, But Keyboard] [All , But Diskette] [All, But Disk/Key]

## 2.6.4 Security

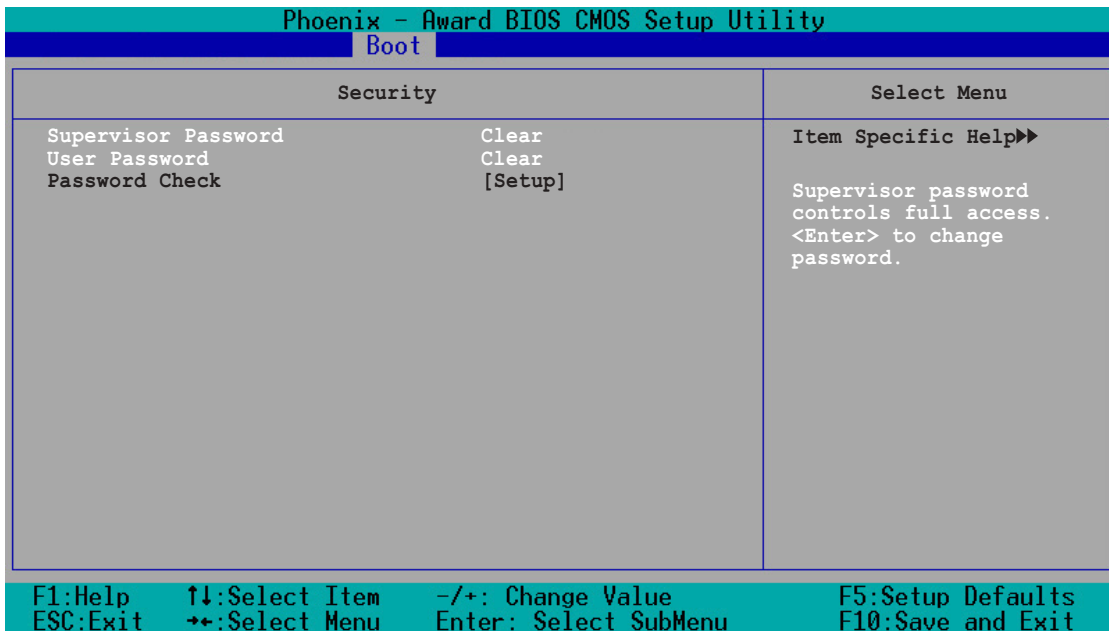

### Supervisor Password [Clear] User Password [Clear]

These fields allow you to set passwords.

To set a password:

1. Highlight an item then press <Enter>.
2. Type in a password using eight (8) alphanumeric characters, then press <Enter>.
3. When prompted, confirm the password by typing the exact characters again, then press <Enter>. The password field setting is changed to [Set].

To clear the password:

1. Highlight the password field, and press <Enter> twice. The following message appears:  
"PASSWORD DISABLED!!! Press any key to continue..."
2. Press any key to return to the menu.

### A note about passwords

The Supervisor password is required to enter the BIOS Setup program preventing unauthorized access. The User password is required to boot the system preventing unauthorized use.

### Forgot the password?

If you forget your password, you can clear it by erasing the CMOS Real Time Clock (RTC) RAM. The RAM data containing the password information is powered by the onboard button cell battery. If you need to erase the CMOS RAM, refer to section “1.6 Jumpers” for instructions.

## Password Check [Setup]

This field requires you to enter the password before entering the BIOS setup or the system. Select [Setup] to require the password before entering the BIOS Setup. Select [System] to require the password before entering the system. Configuration options: [Setup] [System]

## 2.7 Exit menu

The Exit menu items allow you to load the BIOS setup default settings, save or discard any changes you made, or exit the Setup utility.

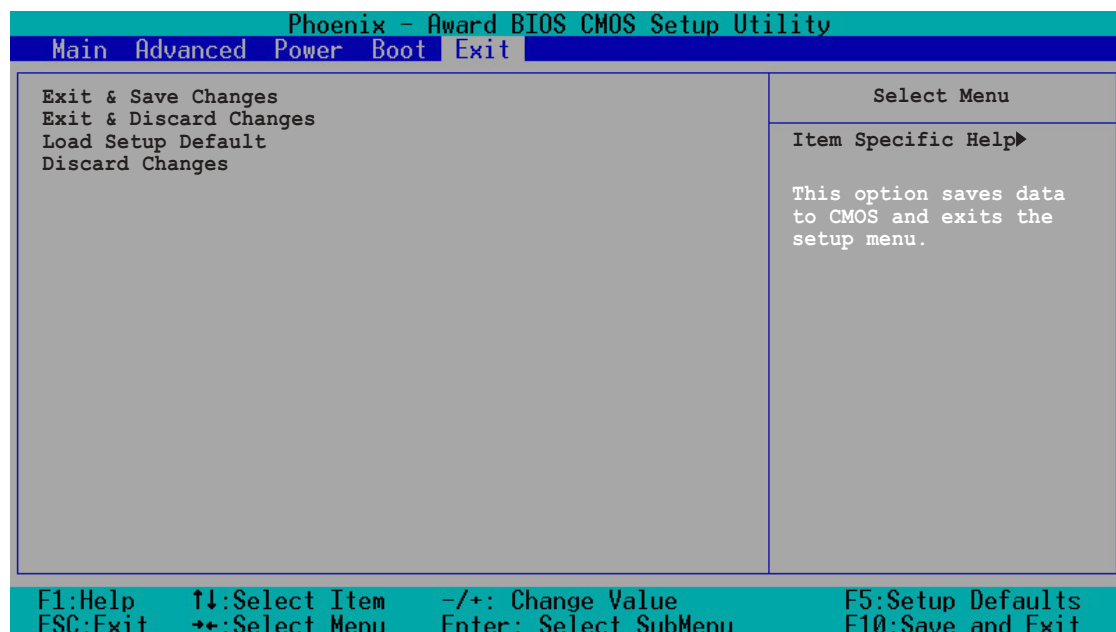

### Exit & Save Changes

Select this option then press <Enter>, or simply press <F10>, to save your changes to CMOS before exiting the Setup utility.

When a confirmation window appears (with a blinking [Y]):

- press <Enter> to save and exit
- type [N], then press <Enter>, or simply press <Esc>, to cancel the command and return to the Exit menu

## **Exit & Discard Changes**

Select this option only if you do not want to save the changes that you made to the Setup program. If you made changes to fields other than system date, system time, and password, the BIOS asks for a confirmation before exiting.

## **Load Setup Defaults**

This option allows you to load the default values for each of the parameters on the Setup menus. When you select this option or if you press <F5>, a confirmation window appears. Select [Yes] to load default values. Select Exit Saving Changes or make other changes before saving the values to the non-volatile RAM.

## **Discard Changes**

This option allows you to discard the selections you made and restore the previously saved values. After selecting this option, a confirmation appears. Select [Yes] to discard any changes and load the previously saved values.

This chapter tells how to install  
SLI-ready PCI Express graphics cards.

**NVIDIA® SLI™**  
**technology**  
**support**

A large, stylized, light gray number '3' is positioned behind the text 'SLI™' and 'technology', serving as a background element for the logo.

## 3.1 Overview

The motherboard supports the NVIDIA® SLI™ (Scalable Link Interface) technology that allows you to install two identical PCI Express™ x16 graphics cards. Follow the installation procedures in this section.

### 3.1.1 Requirements

- You should have two identical SLI-ready graphics cards that are NVIDIA® certified.
- Make sure that your graphics card driver supports the NVIDIA SLI technology. Download the latest driver from the NVIDIA website ([www.nvidia.com](http://www.nvidia.com)).
- Make sure that your power supply unit (PSU) can provide at least the minimum power required by your system. See “8. ATX power connectors” on page 2-25 for details.



- The NVIDIA SLI technology supports Windows® XP™ operating system only.
- Visit the NVIDIA website for the supported 3D applications and the latest graphics card drivers.

### 3.1.2 ASUS Certified SLI Graphics cards

Use only ASUS certified PCI Express x16 SLI graphics cards to ensure optimum performance.

#### GeForce 6800 Ultra models

| Vendor   | Model Number                              |
|----------|---|
| ASUS     | Extreme N6800Ultra (EN6800Ultra)          |
| BFG      | BFGO68256UX                               |
| eVGA     | 256-P2-N377-AX/BX                         |
| Gainward | PowerPack! Ultra/2600 PCX “Golden Sample” |
| Gigabyte | GV-NX68U256D-B                            |
| Leadtek  | WinFast PX6800 Ultra                      |
| MSI      | MS-8974                                   |
| XFx/Pine | XFx GeForce 6800 Ultra                    |

## GeForce 6800 GT models

| Vendor   | Model Number                          |
|----------|---------------------------------------|
| ASUS     | EN6800GT                              |
| BFG      | BFG BFG068256GTOCX                    |
| eVGA     | 256-P2-N376-AX/BX                     |
| Gigabyte | GV-NX68T256DH                         |
| Leadtek  | WinFast PX6800 GT                     |
| XFx/Pine | XFx GeForce 6800GT PCI-E (PV-T45G-UD) |

## GeForce 6600 GT models

| Vendor    | Model Number                             |
|-----------|--|
| Albatron  | GF6600GT                                 |
| AOpen     | Aeolus 6600GT-DV128                      |
| Asus      | Extreme N6600GT                          |
| BFG       | BFGR6600GTOCX                            |
| Chaintech | SE6600G                                  |
| eVGA      | 128-P2-N368-AX/BX                        |
| Gigabyte  | NX66T128D                                |
| Leadtek   | WinFast PX6600GT                         |
| MSI       | MS-8983 NX6600GT-VTD128E/NX6600GT-TD128E |
| Palit     | GeForce 6600GT                           |
| ProLink   | PV-NV43E(128LD)                          |
| Sparkle   | SPPX43                                   |
| XFx/Pine  | XFx GeForce 6600GT PCI-E ( PV-T43G-ND )  |



Visit the NVIDIA zone website ([http://www.nzone.com/object/nzone\\_sli\\_certified.html](http://www.nzone.com/object/nzone_sli_certified.html)) for the latest certified graphics card list.

## 3.2 Dual graphics card setup

### 3.2.1 Setting the ASUS EZ selector card

Your motherboard package comes with a pre-installed ASUS EZ selector card. By default, the card is set for a single graphics card. To use two graphics cards on this motherboard, you must first set the selector card to **Dual Video Cards**.

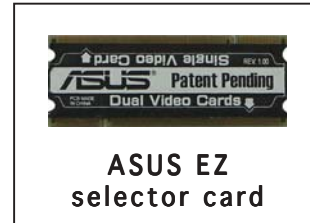

To set the selector card:

1. Locate the selector card on the motherboard.

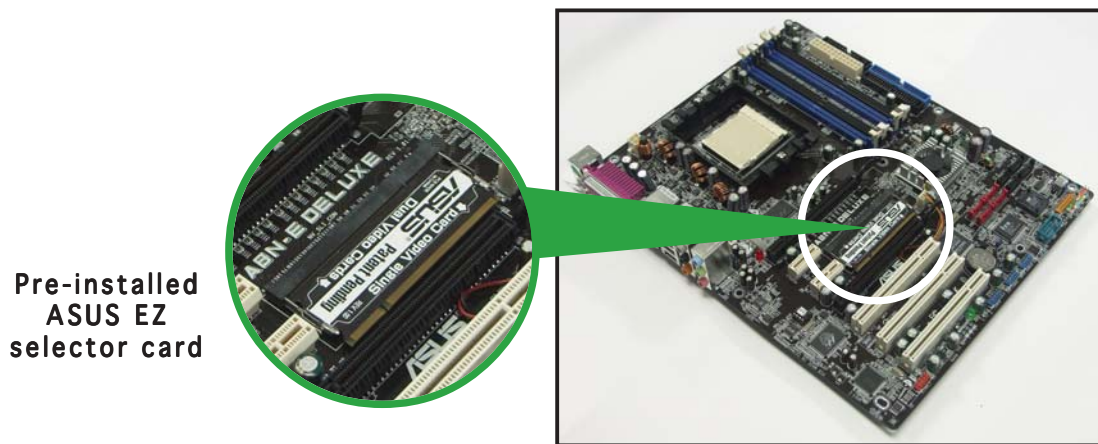

2. Simultaneously push the retention clips outward to release the card.

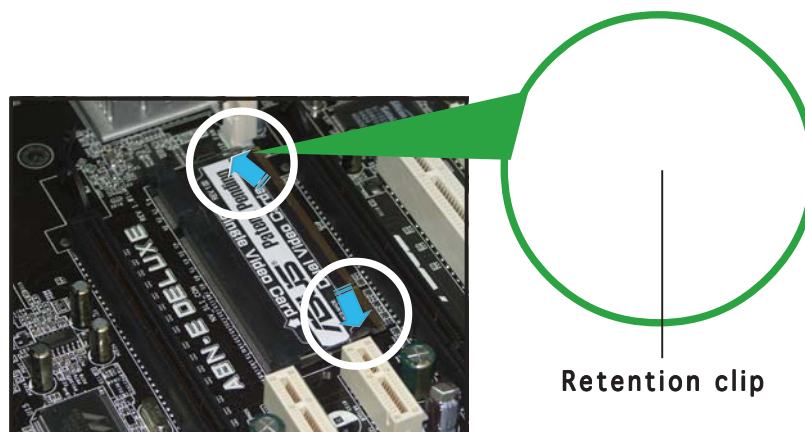



3. When released, pull the selector card out of the slot.

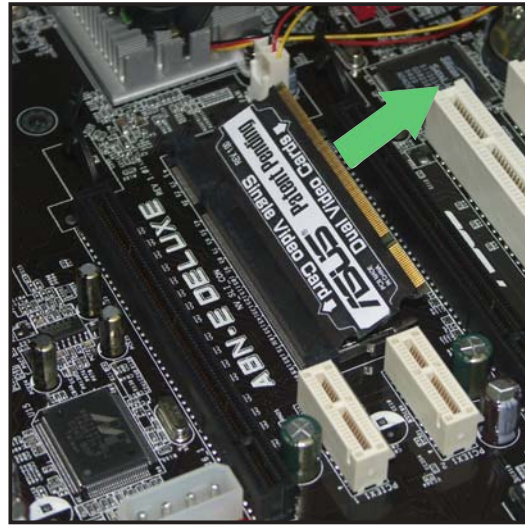

4. Invert the selector card and insert the edge labeled **Dual Video Cards**.

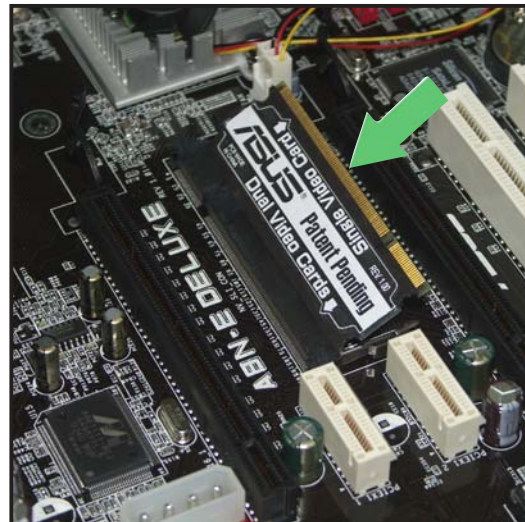

5. Push down the selector card until the retention clips snap into place.



Make sure to completely insert the selector card into the slot.

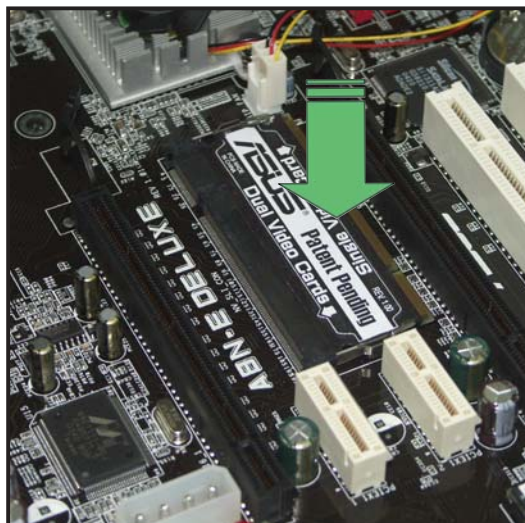

## 3.2.2 Installing SLI-ready graphics cards



---

Install only identical SLI-ready graphics cards that are NVIDIA® certified. Different types of graphics cards will not work together properly.

---

To install the graphics cards:

1. Prepare two graphics cards. Each graphics card should have goldfingers for the SLI connector.

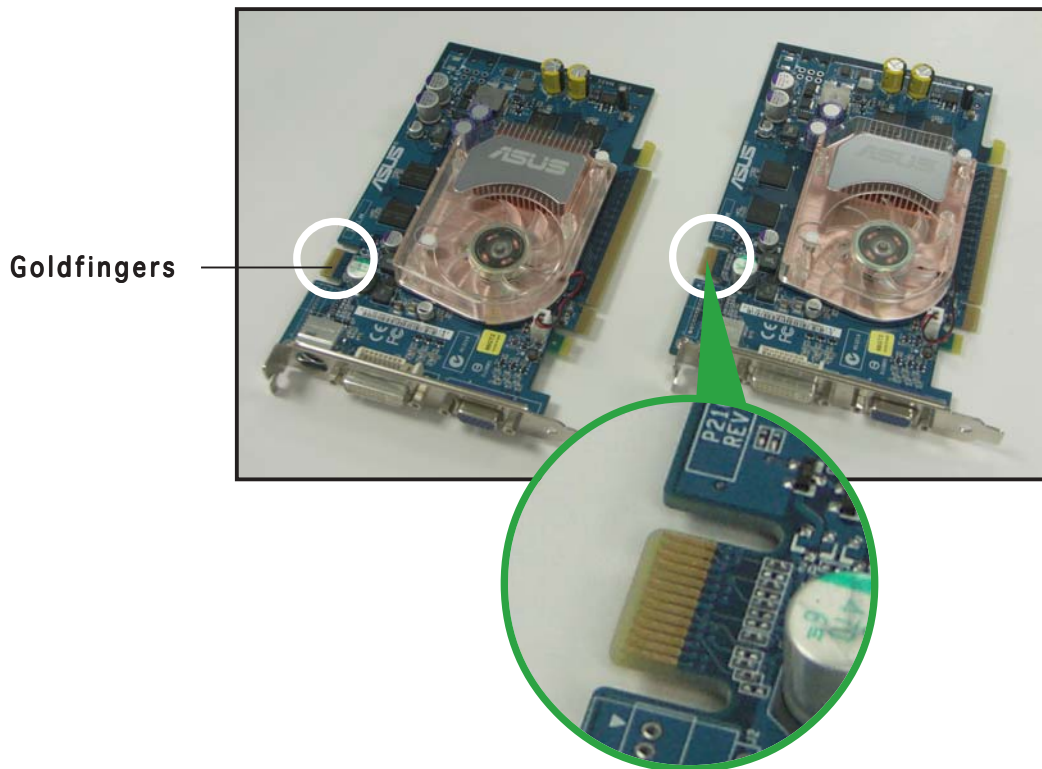

2. Remove the metal bracket covers opposite the two PCI Express x16 slots.

3. Insert one graphics card into the blue slot labeled **PCIEX16\_1**. Make sure that the card is properly seated on the slot.



4. Insert the second graphics card into the black slot labeled **PCIEX16\_2**. Make sure that the card is properly seated on the slot.

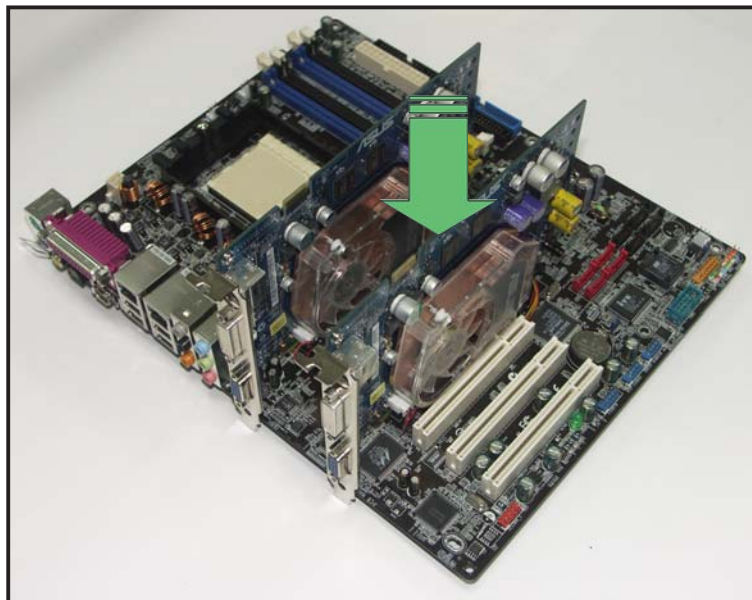

---

If required, connect an auxiliary power source to the PCI Express graphics cards.

---

5. Align and insert the SLI connector to the goldfingers on each graphics card. Make sure that the connector is firmly in place.

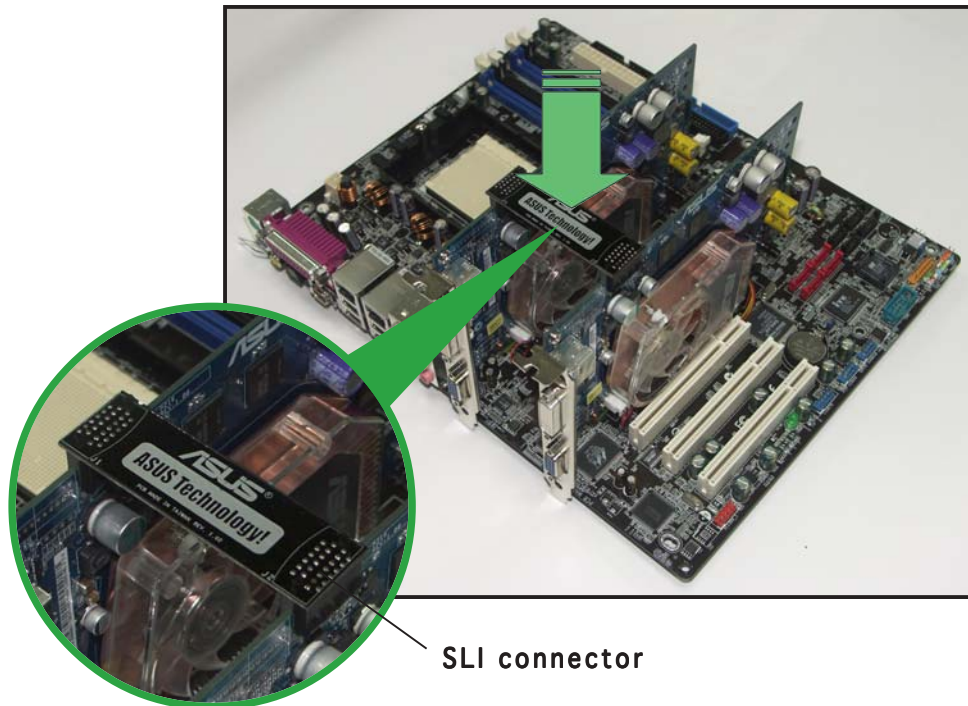

6. Connect a 4-pin ATX power cable to the EZ Plug™ labeled **EZ\_PLUG** on your motherboard.



---

Make sure to connect a 4-pin ATX power cable to the EZ Plug; otherwise, the system will be unstable.

---

ASUS EZ Plug™

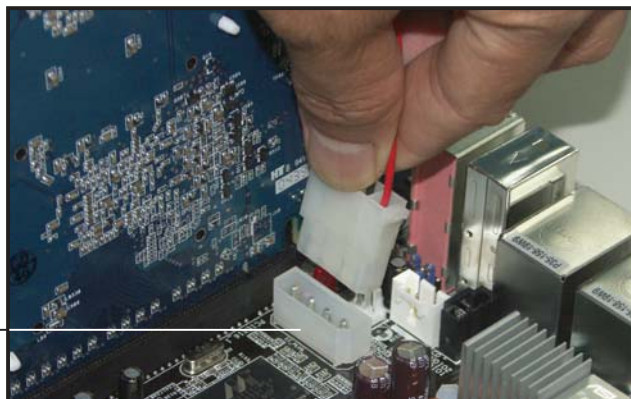

---

The onboard red warning LED lights up if you do not plug a 4-pin ATX power cable to the EZ Plug.

---

7. Remove any of the two bracket covers between the graphics cards.

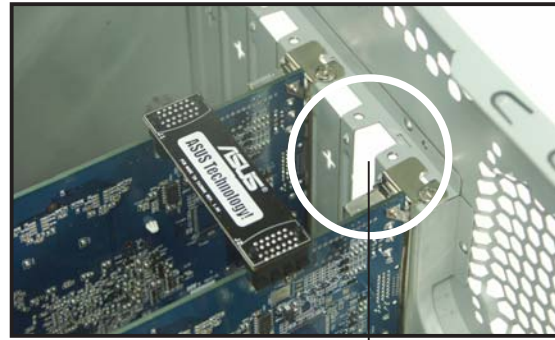

Bracket slot

8. Align and insert the retention bracket into the slot then secure it with a screw.



---

Make sure that the retention bracket firmly supports the two graphics cards.

---



Retention bracket

9. Connect a **VGA cable** or a **DVI-I cable** to the graphics card installed on the **blue** PCI Express slot.

### 3.2.3 Installing the device drivers

Refer to the documentation that came with your graphics card package to install the device drivers.



---

Make sure that your PCI Express graphics card driver supports the NVIDIA SLI technology. Download the latest driver from the NVIDIA website ([www.nvidia.com](http://www.nvidia.com)).

---

### 3.2.4 Enabling the multi-GPU feature in Windows®

After installing your graphics cards and the device drivers, enable the Multi-Graphics Processing Unit (GPU) feature in the NVIDIA nView properties.

To enable the multi-GPU feature:

1. Click the **NVIDIA Settings icon** on your Windows taskbar.

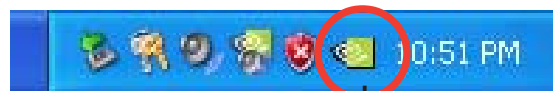

NVIDIA Settings icon

2. From the pop-up menu, select **nView Desktop Manager** then click **nView Properties**.

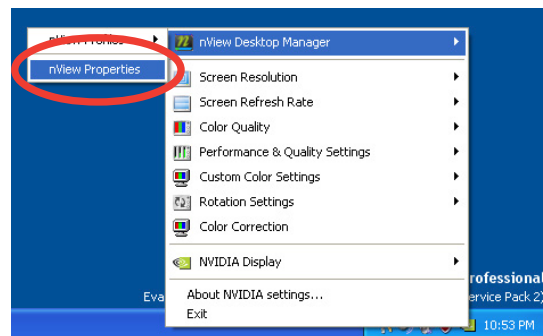

3. From the nView Desktop Manager window, select the **Desktop Management** tab.
4. Click **Properties** to display the Display Properties dialog box.



5. From the Display Properties dialog box, select the **Settings** tab then click **Advanced**.

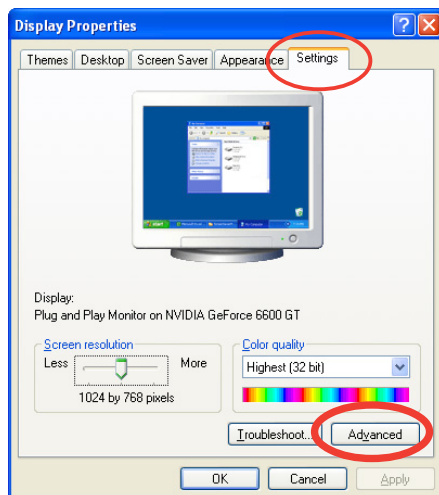

6. Select the **NVIDIA GeForce** tab.

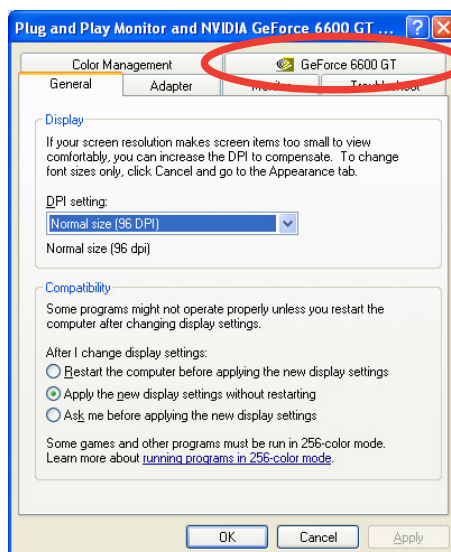

7. Click the slider to display the following screen, then select the **SLI multi-GPU** item.

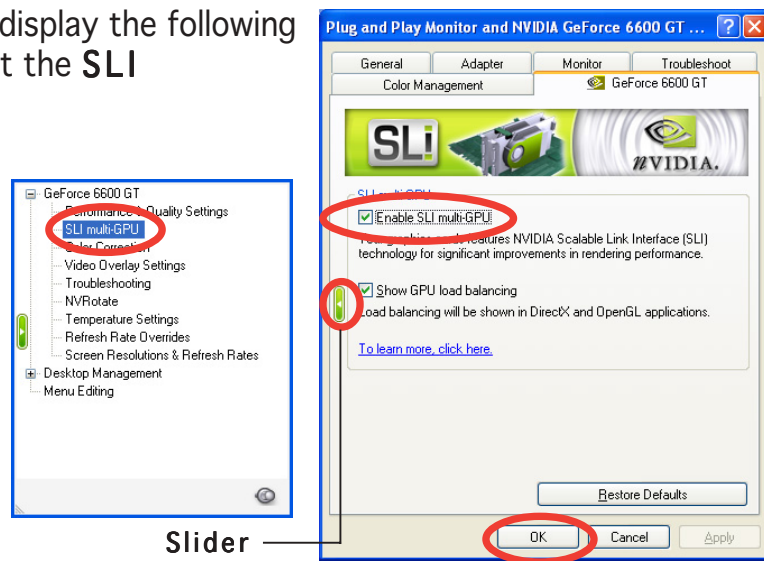

8. Click the **Enable SLI multi-GPU** check box.
9. Click **OK** when done.