

AV Control Stereo Receiver

SA-AX730 SA-AX530

Operating Instructions

Technics®



The photographs show SA-AX730.

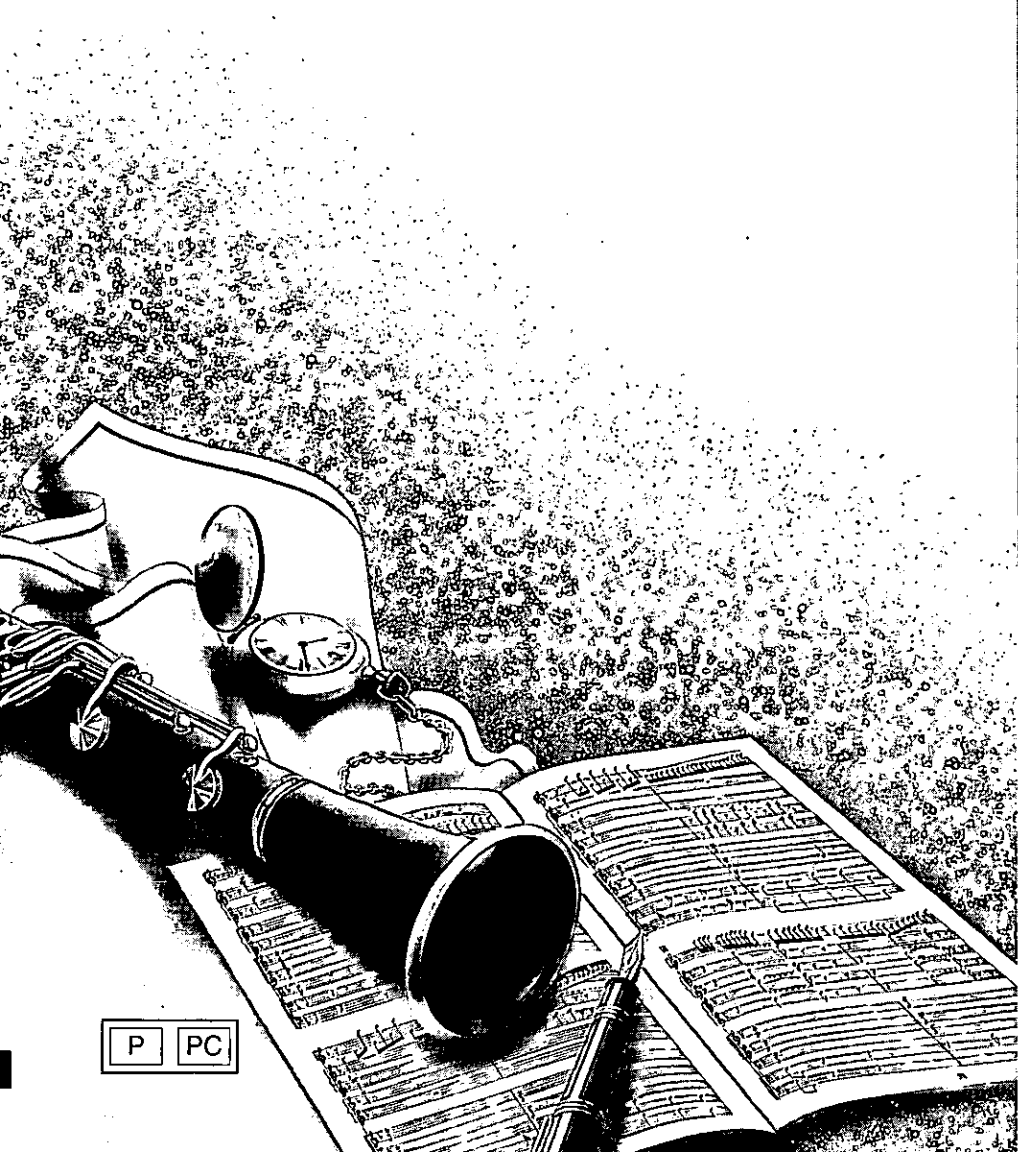

Before connecting, operating or adjusting this product, please read these instructions completely. Please save this manual.

P PC

RQT4731-P

Dear Customer

Thank you for purchasing this product.
For optimum performance and safety, please read these instructions carefully.

Table of contents

Precautions	3
Supplied accessories	4
Concerning the remote control	4
Surround guide	5
Front panel controls	6
Equipment connections	8
Antenna connections	12
Speaker connections	14
<hr/>	
Basic operations	16
Listening to radio broadcasts	18
Sequential tuning	18
Direct tuning	19
Preset tuning	20
Dolby Pro Logic	22
Setting the center mode and adjusting speaker output level	22
Adjusting the delay time	24
Enjoying SURROUND or 3 STEREO	25
SFC (Sound Field Control)	26
Adjusting field of sound	27
DVD 6CH INPUT mode	28
Other functions	29
To adjust the tone quality	29
To adjust the sound balance	29
To mute the sound level	29
To listen through headphones	29
Making a recording	30
Recording on a tape deck	30
Recording on a VCR	30
Using the remote control	31
To operate the receiver	31
To operate a cassette deck	32
To operate a CD changer or CD player	33
To watch TV broadcasts	34
To watch video tapes	35
To operate a DVD player	36
Changing the remote control code.	
SA-AX730 only	37
<hr/>	
About the HELP function	38
Listening caution	38
Maintenance	38
Product Service	38
Troubleshooting guide	39
Technical specifications	Back cover

These operating instructions are applicable to models SA-AX730 and SA-AX530, however, are intended primarily for model SA-AX730.

User memo:

DATE OF PURCHASE _____
DEALER NAME _____
DEALER ADDRESS _____
TELEPHONE NUMBER _____

The model number and serial number of this product can be found on either the back or the bottom of the unit. Please note them in the space provided below and keep for future reference.

MODEL NUMBER _____
SERIAL NUMBER _____

THE FOLLOWING APPLIES ONLY IN THE U.S.A.

CAUTION:

Any unauthorized changes or modifications to this equipment would void the user's authority to operate this device.

WARNING:

TO REDUCE THE RISK OF FIRE, ELECTRIC SHOCK OR PRODUCT DAMAGE, DO NOT EXPOSE THIS APPLIANCE TO RAIN, SPLASHING, DRIPPING OR MOISTURE.

CAUTION:

TO PREVENT ELECTRIC SHOCK MATCH WIDE BLADE OF PLUG TO WIDE SLOT, FULLY INSERT.



CAUTION: TO REDUCE THE RISK OF ELECTRIC SHOCK, DO NOT REMOVE SCREWS. NO USER-SERVICEABLE PARTS INSIDE. REFER SERVICING TO QUALIFIED SERVICE PERSONNEL.

CAUTION

Do not place a tape deck, CD, or DVD player on top of this unit. Heat radiated from the top of this unit may cause damage to the software.

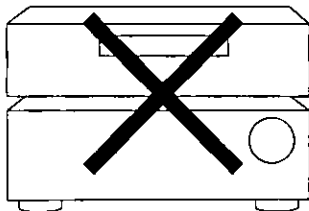

NO



The lightning flash with arrowhead symbol, within an equilateral triangle, is intended to alert the user to the presence of uninsulated "dangerous voltage" within the product's enclosure that may be of sufficient magnitude to constitute a risk of electric shock to persons.



The exclamation point within an equilateral triangle is intended to alert the user to the presence of important operating and maintenance (servicing) instructions in the literature accompanying the appliance.

Precautions

Before using this unit please read these operating instructions carefully. Take special care to follow the warnings indicated on the unit itself as well as the safety suggestions listed below. Afterwards keep them handy for future reference.

Safety

1. **Power Source**—The unit should be connected to power supply only of the type described in the operating instructions or as marked on the unit.
2. **Polarization**—If the unit is equipped with a polarized AC power plug (a plug having one blade wider than the other), that plug will fit into the AC outlet only one way. This is a safety feature. If you are unable to insert the plug fully into the outlet, try reversing the plug. If the plug should still fail to fit, contact your electrician to replace your obsolete outlet. Do not defeat the safety purpose of the polarized plug.
3. **Power Cord Protection**—AC power supply cords should be routed so that they are not likely to be walked on or pinched by items placed upon or against them. Never take hold of the plug or cord if your hand is wet, and always grasp the plug body when connecting or disconnecting it.
4. **Nonuse Periods**—When the unit is not used, turn the power off. When left unused for a long period of time, the unit should be unplugged from the household AC outlet.

Installation

Environment

1. **Outdoor Antenna Grounding**—If an outside antenna is connected to the receiver, be sure the antenna system is grounded so as to provide some protection against voltage surges and built-up static charges. Section 810 of the National Electrical Code, ANSI/NFPA No. 70-1990, provides information with respect to proper grounding of the mast and supporting structure, grounding of the lead-in wire to an antenna discharge unit, size of grounding conductors, location of antenna-discharge unit, connection to grounding electrodes, and requirements for the grounding electrode. See figure below.

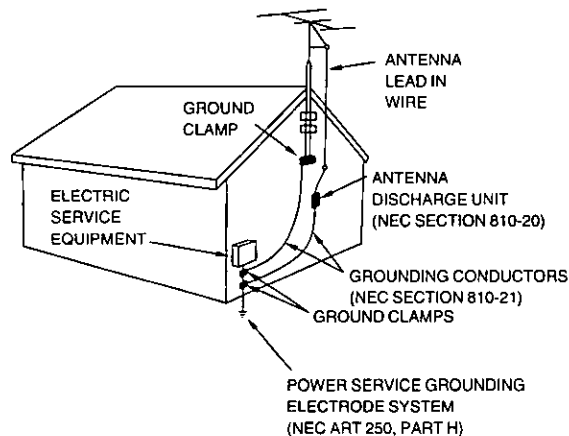

NEC—NATIONAL ELECTRICAL CODE

2. **Water and Moisture**—Do not use this unit near water—for example, near a bathtub, washbowl, swimming pool, or the like. Damp basements should also be avoided.
3. **Heat**—The unit should be situated away from heat sources such as radiators and the like. It also should not be placed in temperatures less than 5°C (41°F) or greater than 35°C (95°F).

Placement

1. **Ventilation**—The unit should be situated so that its location or position does not interfere with its proper ventilation. Allow 10 cm (4") clearance from the rear of the unit.
2. **Foreign Material**—Care should be taken so that objects do not fall into and liquids are not spilled into the unit. Do not subject this unit to excessive smoke, dust, mechanical vibration, or shock.
3. **Magnetism**—The unit should be situated away from equipment or devices that generate strong magnetic fields.
4. **Stacking**—Do not place heavy objects, other than system components, on top of the unit.
5. **Surface**—Place the unit on a flat, level surface.
6. **Carts and Stands**—The unit should be used only with a cart or stand that is recommended by the manufacturer. The unit and cart combination should be moved with care. Quick stops, excessive force, and uneven surfaces may cause the unit and cart combination to overturn.
7. **Wall or Ceiling Mounting**—The unit should not be mounted to a wall or ceiling, unless specified in this operating instructions.



Maintenance

Clean the cabinet, panel and controls with a soft cloth lightly moistened with mild detergent solution. Do not use any type of abrasive pad, scouring powder or solvent such as alcohol or benzine.

Service

1. **Damage Requiring Service**—The unit should be serviced by qualified service personnel when:
 - (a) The AC power supply cord or the plug has been damaged; or
 - (b) Objects have fallen or liquid has been spilled into the unit; or
 - (c) The unit has been exposed to rain; or
 - (d) The unit does not appear to operate normally or exhibits a marked change in performance; or
 - (e) The unit has been dropped, or the enclosure damaged.
2. **Servicing**—The user should not attempt to service the unit beyond that described in the operating instructions. All other servicing should be referred to an authorized service personnel.

For the address of an authorized servicenter:

In the U.S.A. 1-800-211-7262 or web site

(<http://www.panasonic.com>)

In Canada 905-624-5505 or web site

(www.panasonic.ca/fdbckca.htm)

Before use

Supplied accessories **A**

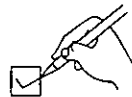
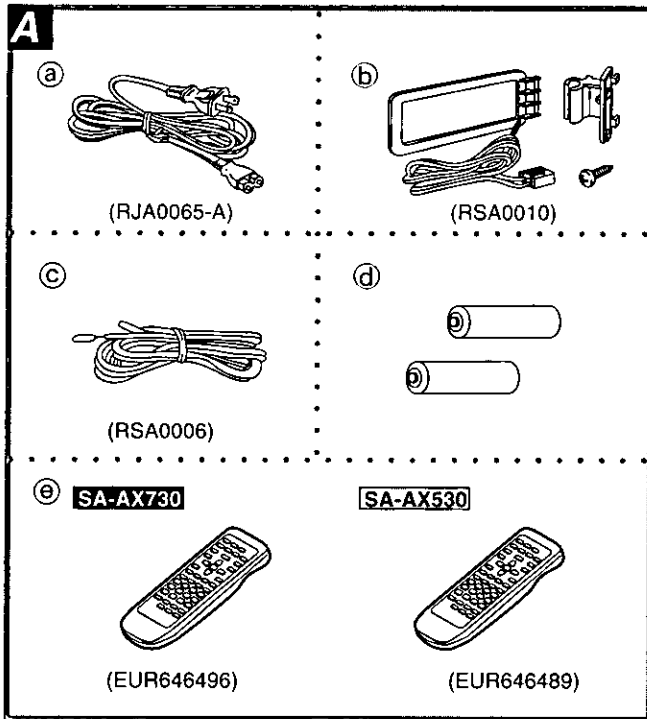

Please check and identify the supplied accessories.

- (a) AC power supply cord 1 pc.
- (b) AM loop antenna set
 - AM loop antenna 1 pc.
 - AM loop antenna holder 1 pc.
 - Screw 1 pc.
- (c) FM indoor antenna 1 pc.
- (d) Batteries 2 pcs.
- (e) Remote control transmitter 1 pc.

Use numbers indicated in parentheses when asking for replacement parts.

(Only for U.S.A.)

To order accessories contact 1-800-332-5368 or web site (<http://www.panasonic.com>).

Concerning the remote control **B**

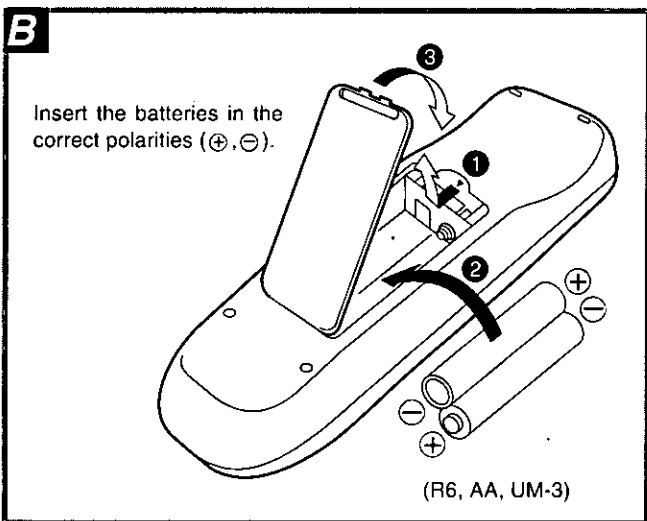

Battery installation **B**

Use of batteries

- Do not mix old and new batteries, or batteries of different types (manganese and alkaline, etc.).
- Never subject batteries to excessive heat or flame; do not attempt to disassemble them; and be sure they are not short-circuited.
- If the remote control is not to be used for a long period of time, remove the batteries and store them in a cool, dark place.
- Do not attempt to recharge alkaline or carbon batteries.
- Do not use rechargeable type batteries.

Correct method of use **C**

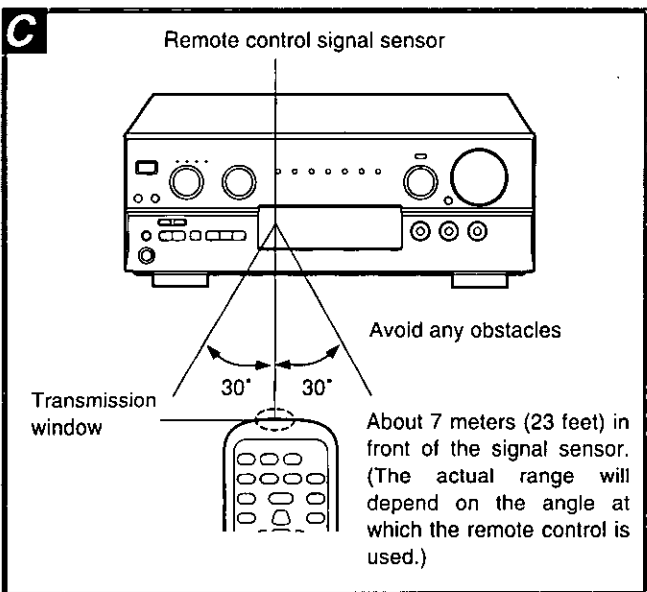

Operation notes

- Do not place obstacles between the remote control signal sensor and remote control unit.
- Do not expose the remote control signal sensor to direct sunlight or to the bright light of an inverter fluorescent light.
- Take care to keep the remote control signal sensor and end of the remote control unit free from dust.
- If the unit is installed in a rack with glass doors, the glass doors' thickness or color might make it necessary to use the remote control a shorter distance from the unit.

To prevent damage

- Never place heavy items on top of the unit.
- Do not disassemble or reconstruct the unit.
- Do not spill water or other liquids into the unit.

You are able to enjoy these two surround systems with this receiver.

Surround system

Dolby Pro Logic

Dolby Pro Logic is a decoding system that was developed to get a better sense of presence from sources encoded with Dolby Surround. The feeling of position has been improved by the addition of a separate center speaker channel. Dolby Surround was developed to allow enjoyment of Dolby Stereo, a cinema system, in private homes. This system reproduces sound close to that of the original movie through use of an analog matrix.

This unit has two types of Dolby Pro Logic.

- **SURROUND:** the surround speakers are used.
 - **3 STEREO:** the surround speakers are not used.
- (⇒Page 22.)

Software

- Video tapes
- Laser discs
- DVDs
- CDs

Software encoded with Dolby Surround can be identified with this mark.



SFC (Sound Field Control)

SFC allows you to add surround-like effects to sources not formatted with Dolby Surround, Dolby Digital, or DTS. Various effects, like a concert hall or jazz club, can be achieved by introducing width or reverberation to the original sound.

(⇒Page 26.)

Any kind, but particularly music CDs and video tapes.

Other surround systems

The following systems require special decoders. To enjoy them connect unit with the decoders. The playback equipment itself may contain the decoder or you may need to obtain a digital surround processor, such as a Technics SH-AC500D.

Dolby Digital (AC-3)

Dolby Digital is a discrete 6 (5.1) channel digital surround system developed for cinema use. The sound signals in Dolby Digital format are compressed to 1/10 their original size, allowing an entire movie to be recorded on a single DVD. Not all Dolby Digital sources are recorded with 6 channels. Some sources marked Dolby Digital may be recorded in Dolby Surround, a 2 channel system.

(⇒Page 28.)

- DVDs

Both the playback equipment and software must have this mark.



DTS

DTS is a discrete 6 (5.1) channel digital surround system developed for cinema use. Sources encoded in DTS are only compressed to a quarter of the size of the original to preserve sound quality.

DTS sources are produced with the intention that all speaker channels will be used.

(⇒Page 28.)

- DVDs
- Laser discs
- CDs

Both the playback equipment and software must have this mark.



Before use

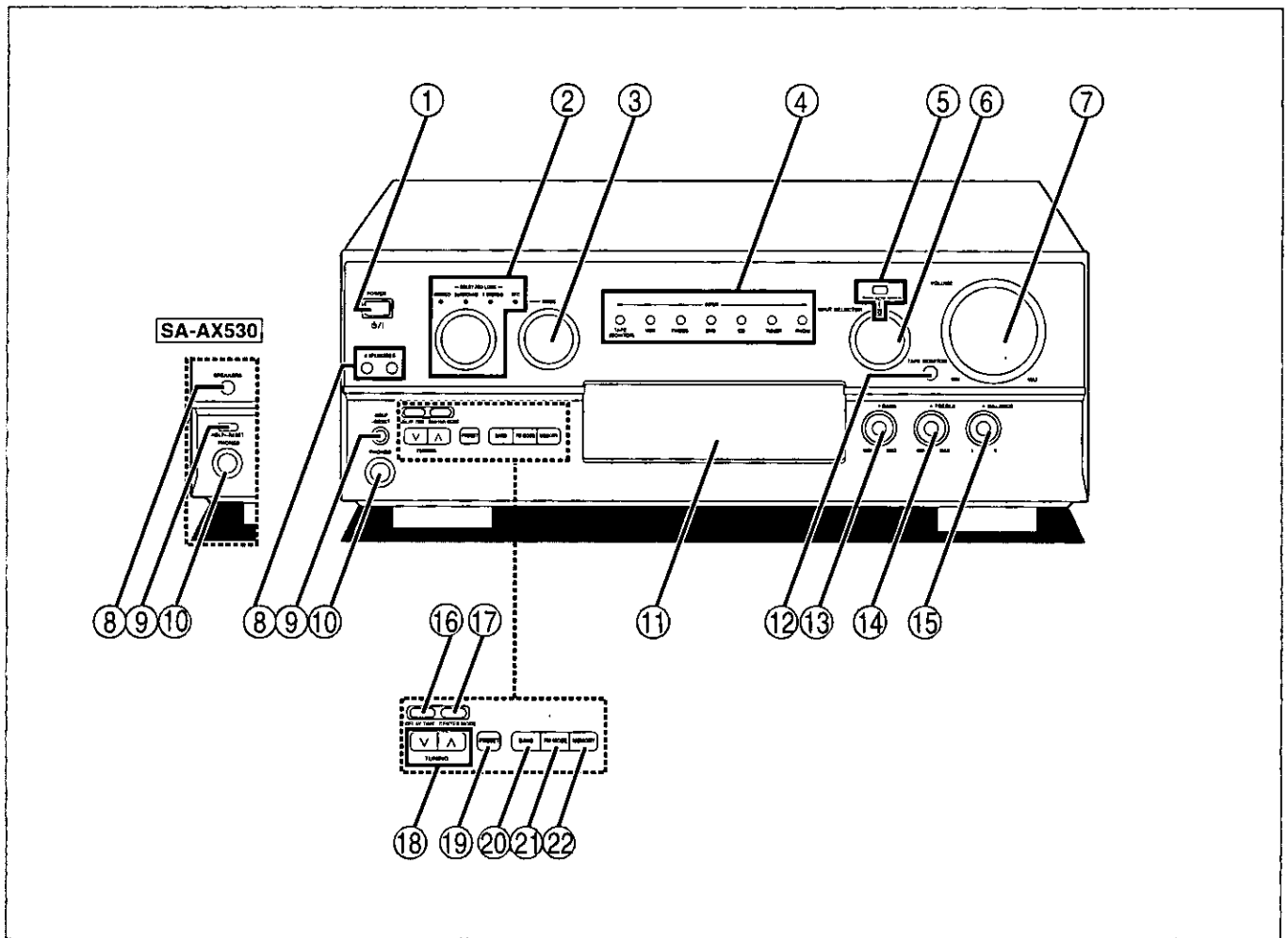

Main unit

No.	Name	Ref. page
①	Power "⏻/⏻" switch (POWER, ⏻/⏻).....	16
	Press to switch the unit from on to standby mode or vice versa. In standby mode, the unit is still consuming a small amount of power.	
②	Sound mode selector/indicators	22
③	SFC mode selector (MODE)	26
④	Input indicators	16
⑤	DVD 6ch input select button/indicator (DVD 6CH INPUT)	28
⑥	Input selector (INPUT SELECTOR)	16
⑦	Volume control (VOLUME)	16
⑧	SA-AX730 Speaker select buttons (SPEAKERS A, B)	16
	SA-AX530 Speaker button (SPEAKERS).....	16

No.	Name	Ref. page
⑨	Help/reset button (-HELP -RESET)	38
⑩	Headphones jack (PHONES)	29
⑪	Display	
⑫	Tape monitor button (TAPE MONITOR)	17
⑬	Bass control (BASS)	29
⑭	Treble control (TREBLE)	29
⑮	Balance control (BALANCE)	29
⑯	Delay time adjust button (DELAY TIME)	24
⑰	Center mode select button (CENTER MODE)	22
⑱	Tuning buttons (TUNING ∇, △).....	18
⑲	Radio station presetting button (PRESET)	21
⑳	Band select button (BAND)	18
㉑	FM mode select button (FM MODE)	18
㉒	Memory button (MEMORY)	20

Remote control

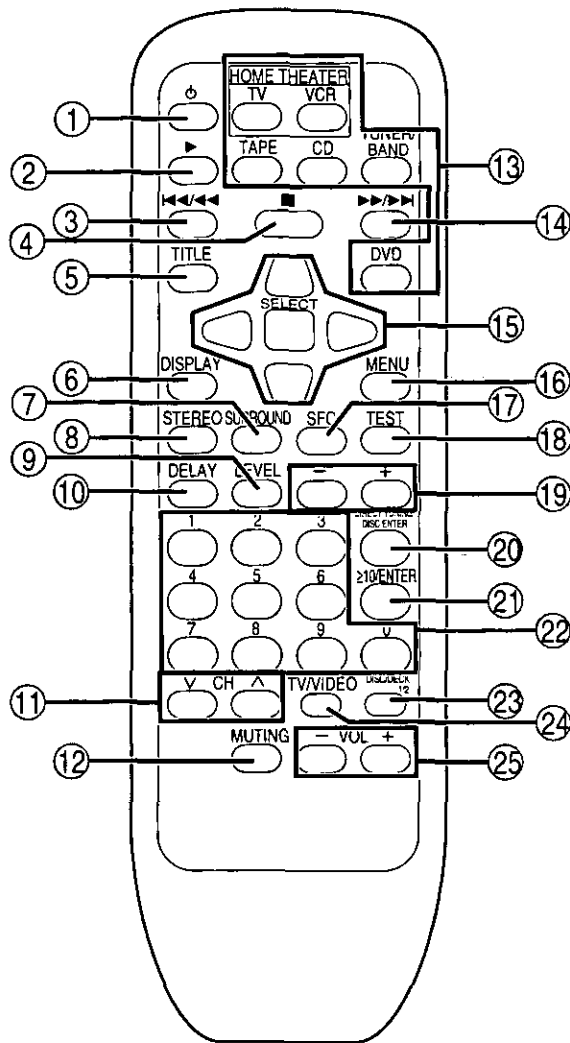

No.	Name	Ref. page
①	Power button (⏻)	31
②	▶ button (▶)	32
③	◀/◀◀ button (◀/◀◀)	32
④	■ button (■)	32
⑤	Title button (TITLE)	36
⑥	Display button (DISPLAY)	36
⑦	Dolby Pro Logic surround select button (SURROUND)	31
⑧	Dolby Pro Logic/SFC off button (STEREO)	31
⑨	Speaker channel select button (LEVEL)	31
⑩	Delay time button (DELAY)	31
⑪	Channel up/down buttons (√CH^)	32
⑫	Muting button (MUTING)	31
⑬	Input select buttons (TV, VCR, TAPE, CD, TUNER/BAND, DVD)	31
⑭	▶▶/▶▶ button (▶▶/▶▶)	32
⑮	Cursor/select buttons	36
⑯	Menu button (MENU)	36
⑰	SFC mode select button (SFC)	31
⑱	Test button (TEST)	23, 31
⑲	Delay time/level adjust buttons (-, +)	23, 31
⑳	Direct tuning/disc enter button (DIRECT TUNING/DISC ENTER)	19, 32
㉑	For SA-AX730 ≥10/enter button (≥10/ENTER)	32
	For SA-AX530 ≥10 button (≥10)	32
㉒	Numeric buttons	19, 32
㉓	Disc/deck 1/2 select button (DISC/DECK 1/2) ..	32
㉔	TV/video select button (TV/VIDEO)	34
㉕	Volume buttons (-VOL+)	23, 31

Before use



Equipment connections (SA-AX730)

Stereo connection cable (not included)

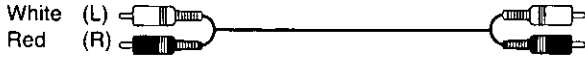

Video connection cable (not included)



Make sure that the power supply for all components has been turned off before making any connections.

To connect equipment, refer to the appropriate operating instructions.

Note

Do not place books, etc., on the top of this unit or block the heat radiation vents in any way.

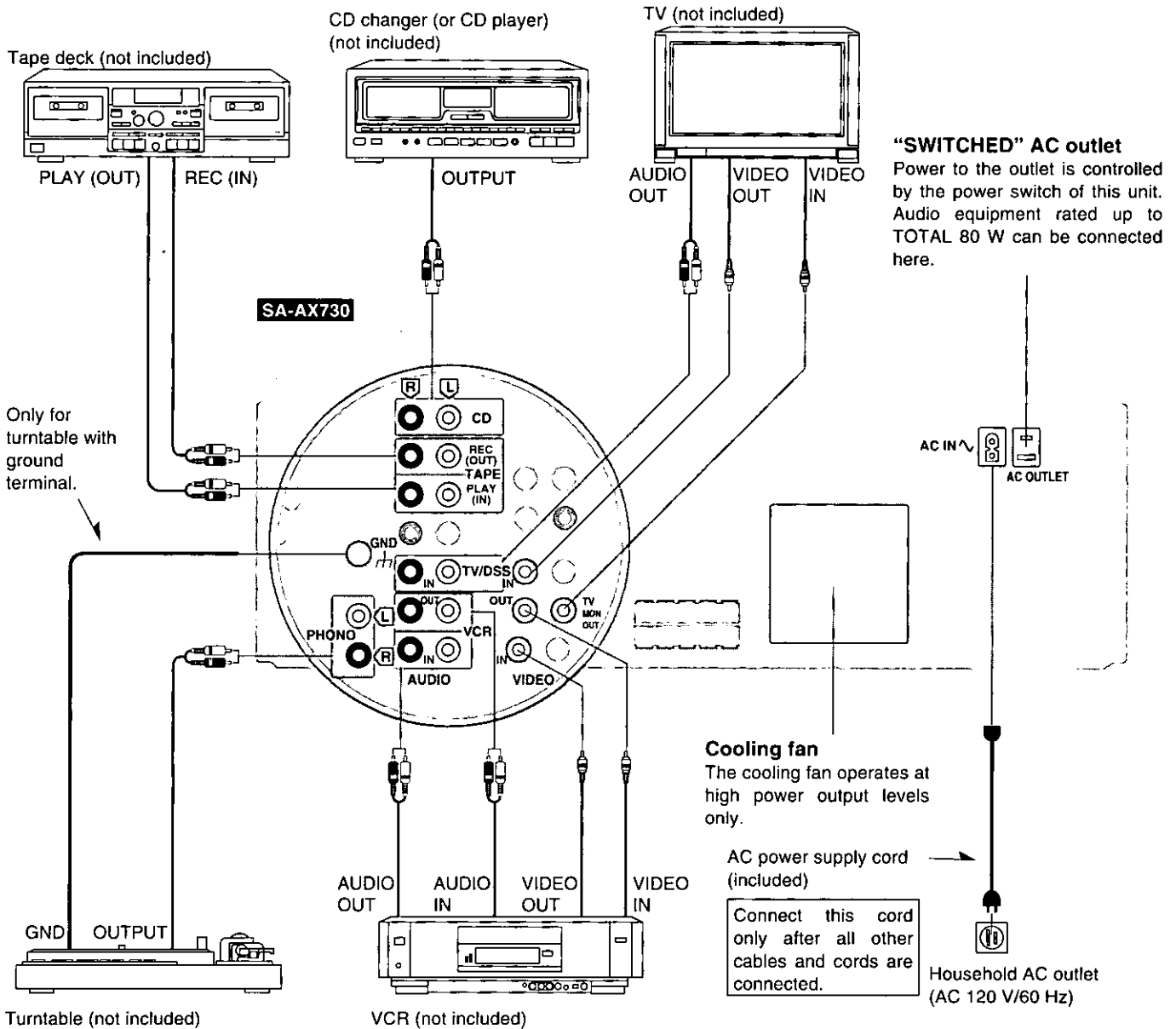

Monaural connection cable (not included)

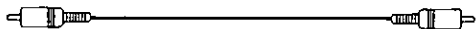

Optical fiber cable (not included)



Connecting a DVD player

6 channel discrete connection enables you to enjoy the sound field effects recorded on DVDs.

SA-AX730

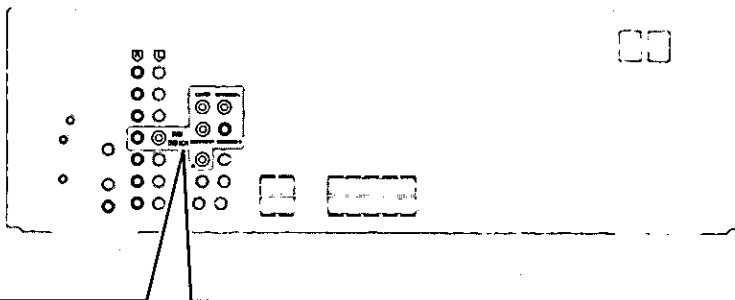

If your DVD player has surround decoders

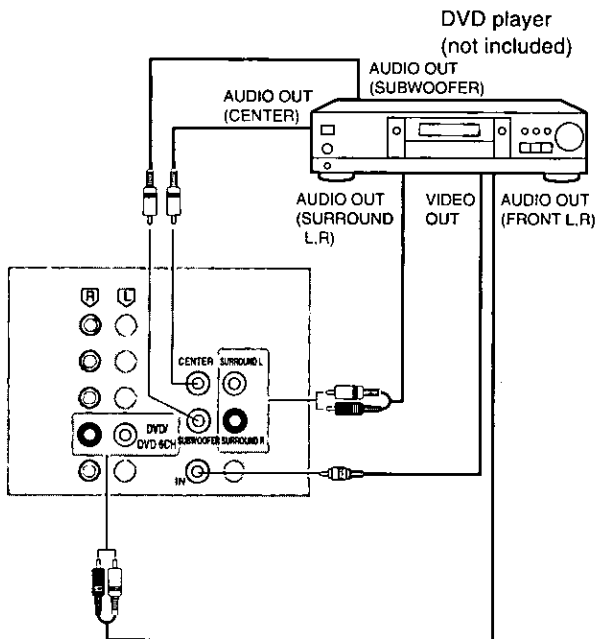

If your DVD player doesn't have surround decoders
Obtain a separately available digital surround processor.

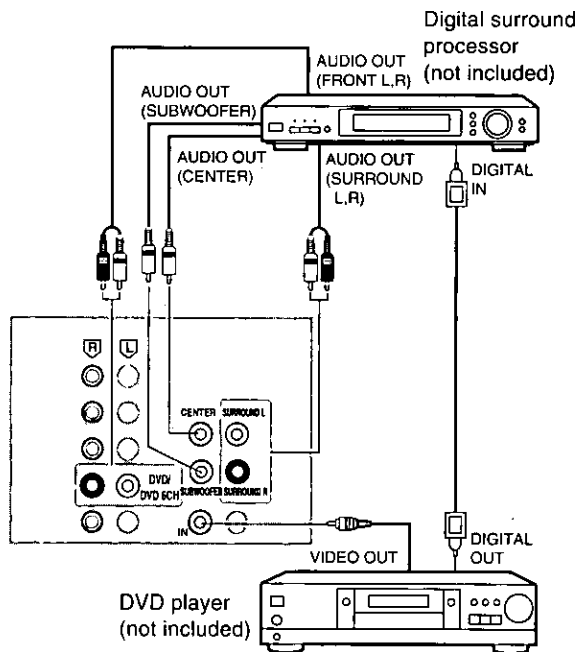

Stereo connection
Use this connection if none of your equipment has a surround decoder.

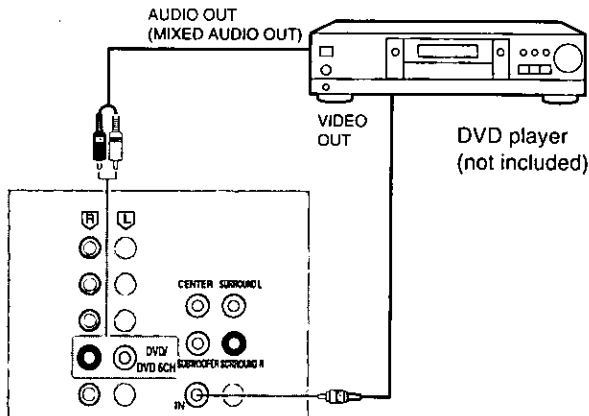

Equipment connections (SA-AX530)

Stereo connection cable (not included)

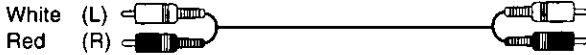

Video connection cable (not included)



Make sure that the power supply for all components has been turned off before making any connections.

To connect equipment, refer to the appropriate operating instructions.

Note

Do not place books, etc., on the top of this unit or block the heat radiation vents in any way.

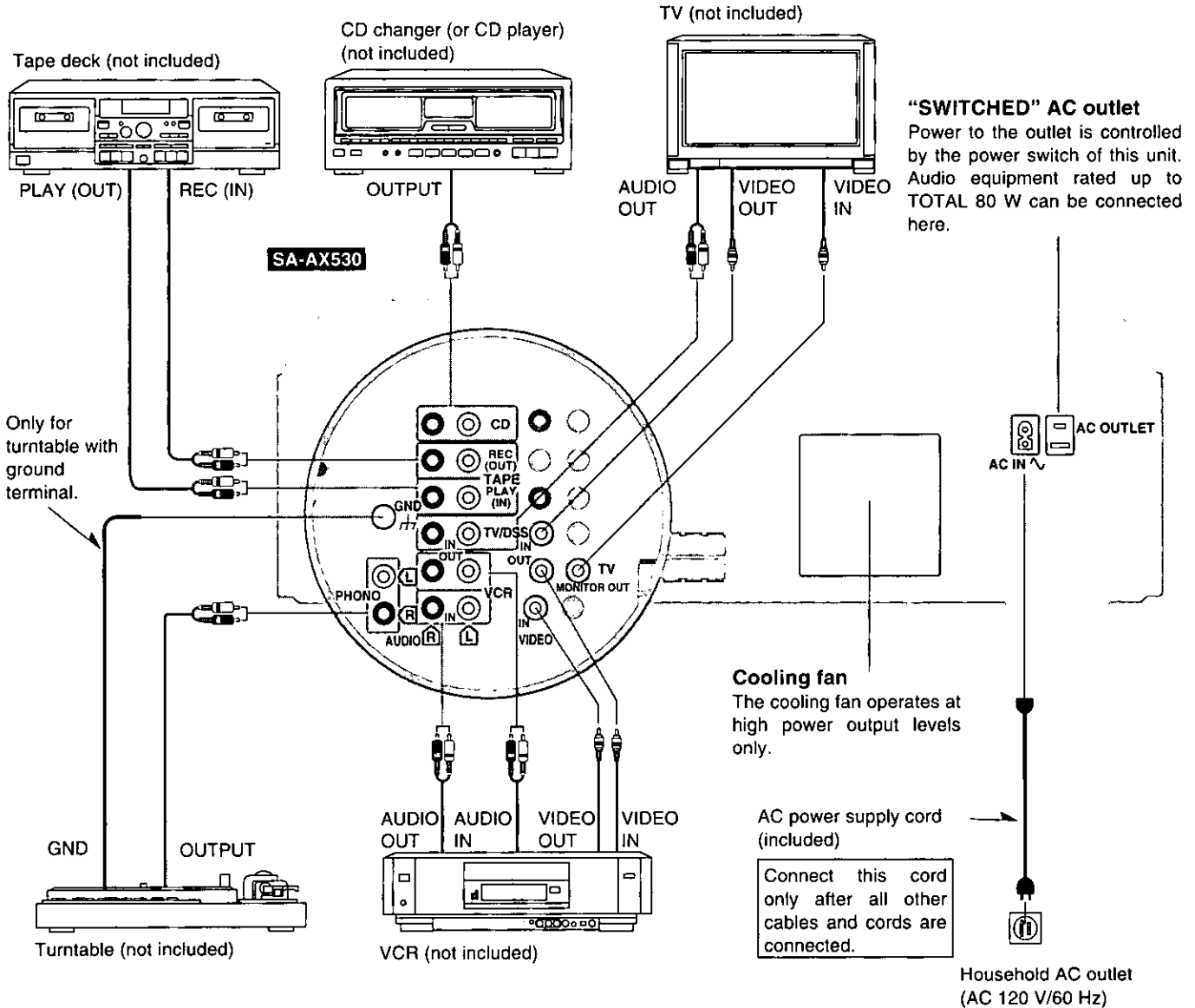

Monaural connection cable (not included)

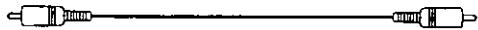

Optical fiber cable (not included)

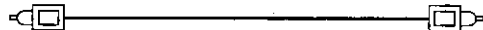

Connecting a DVD player

6 channel discrete connection enables you to enjoy the sound field effects recorded on DVDs.

SA-AX530

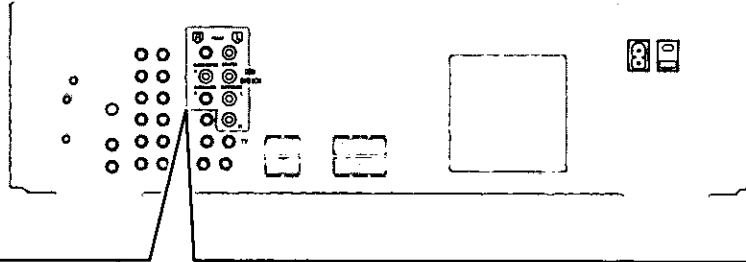

If your DVD player has surround decoders

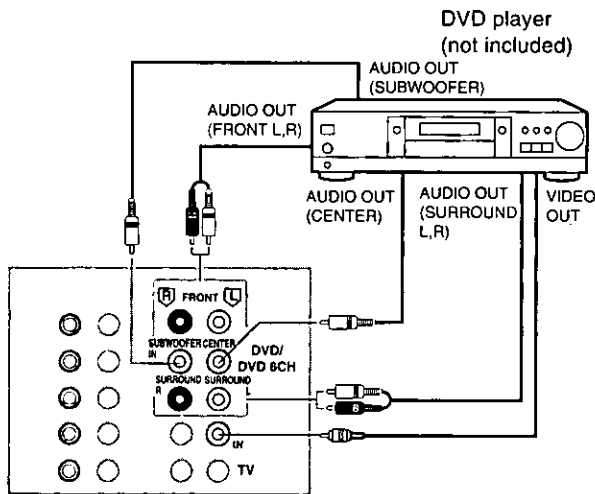

If your DVD player doesn't have surround decoders
Obtain a separately available digital surround processor.

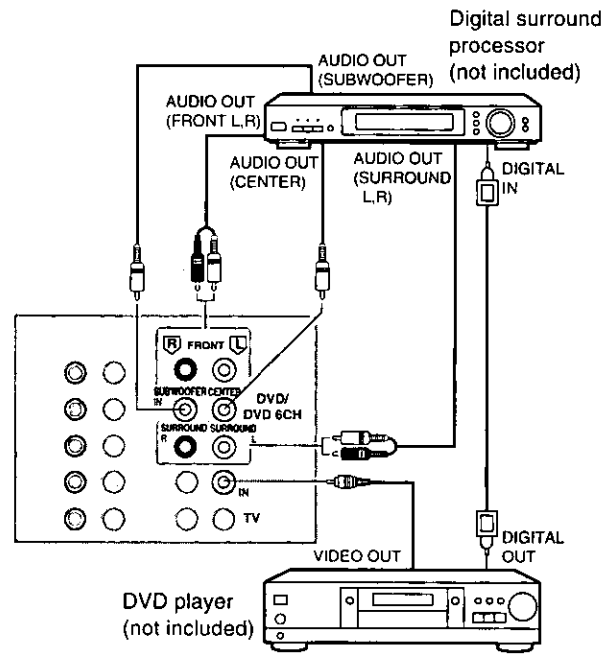

Stereo connection
Use this connection if none of your equipment has a surround decoder.

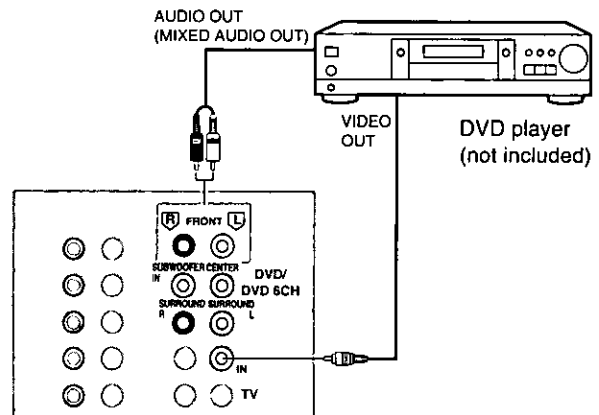

Connections

Antenna connections

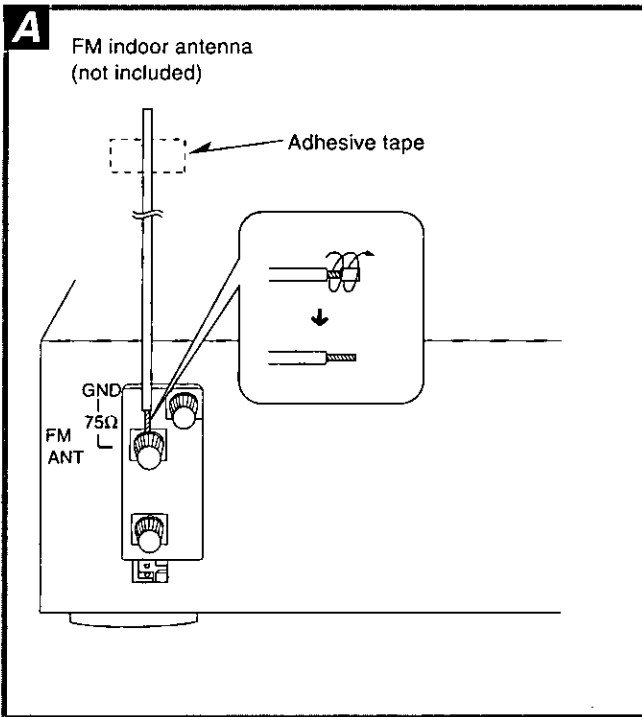

FM indoor antenna (included) **A**

This antenna is normally sufficient for reception of FM broadcasts.

Attach to a wall (using tape) facing in the direction of best reception.

For best reception

An FM outdoor antenna is recommended.

AM loop antenna (included) **B**

This antenna is normally sufficient for reception of AM broadcasts.

Fit the AM loop antenna holder (included) onto the rear panel of this unit and then attach the AM loop antenna to the AM loop antenna holder (facing in the direction of best reception).

Pay attention to the following points when mounting the antenna.

- Do not mount it close to power cords, speaker wires or metal surfaces (Doing so will result in noise).
- Do not mount it close to a tape deck. When the tape deck is being used, chirping or beeping sounds may result.

When mounting the antenna to a column, a wall or rack **C**

Mount the antenna so that the hinge is vertical.

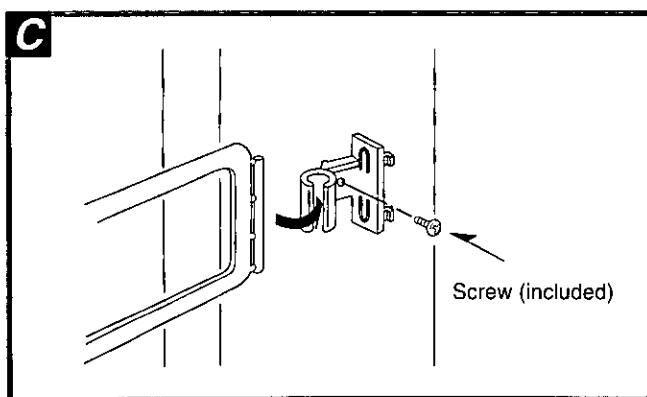
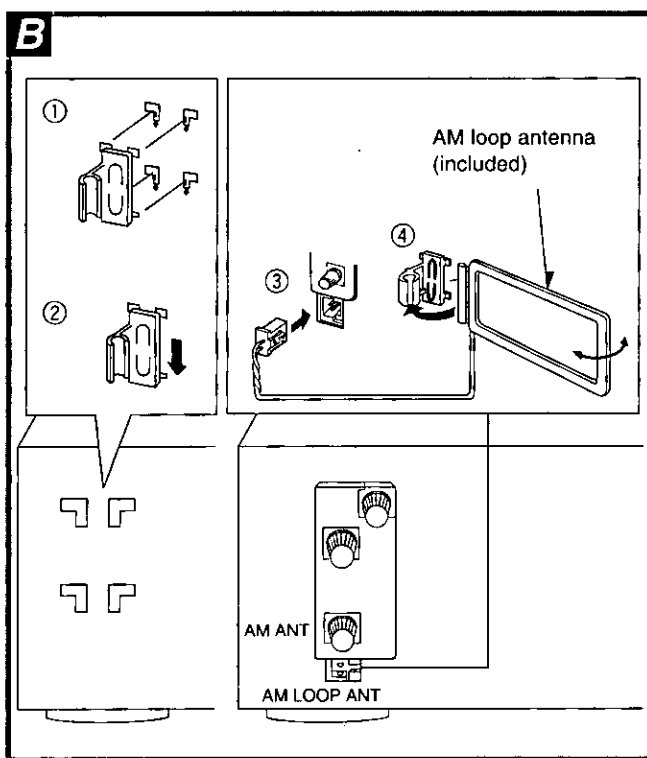

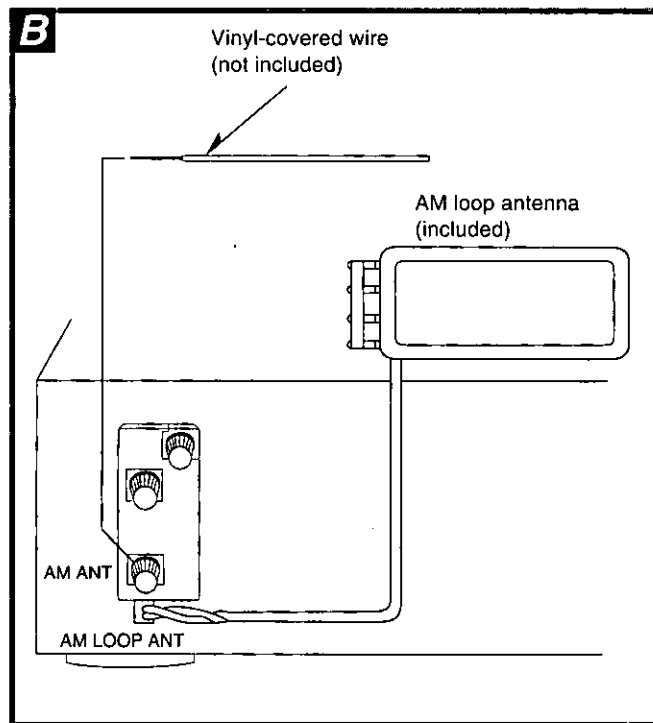
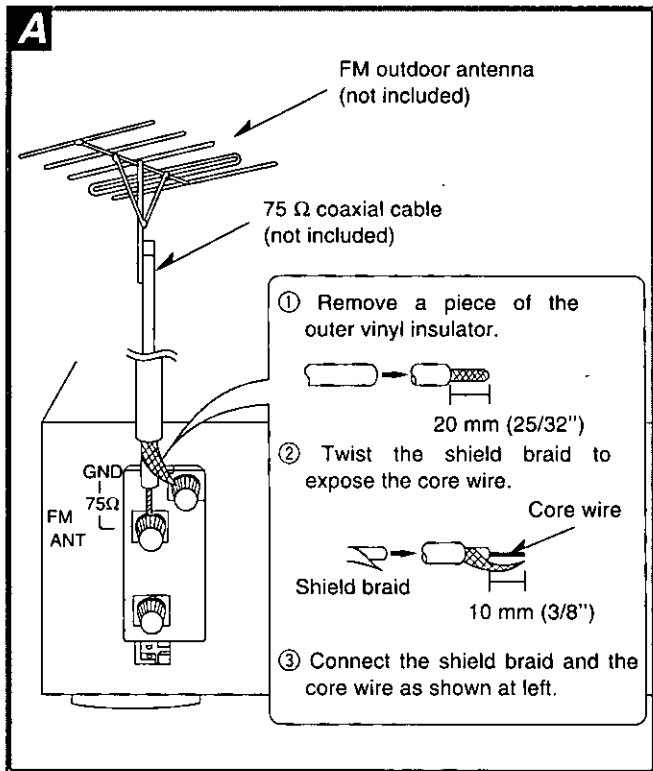

FM outdoor antenna (not included)

A

An outdoor antenna should be used when using this unit in mountainous areas or in spaces enclosed by reinforced concrete where the FM indoor antenna (included) does not provide satisfactory reception. Disconnect the FM indoor antenna if an FM outdoor antenna is installed.

Note

An outdoor antenna should be installed by a qualified technician only.

AM outdoor antenna (not included)

B

An outdoor antenna should be used when using this unit in mountainous areas or in spaces enclosed by reinforced concrete where the AM loop antenna (included) does not provide satisfactory reception.

Stretch 5–12 m (16–40 ft.) of vinyl-covered wire horizontally across a window frame or other convenient location, keeping it as high as possible from the ground.

When the unit is not in use, disconnect the outdoor antenna to prevent possible damage that may be caused by lightning. Never use an outdoor antenna during an electrical storm.

Note

Be sure to connect the AM loop antenna even when an outdoor antenna is used.

Speaker connections

Placement of speakers

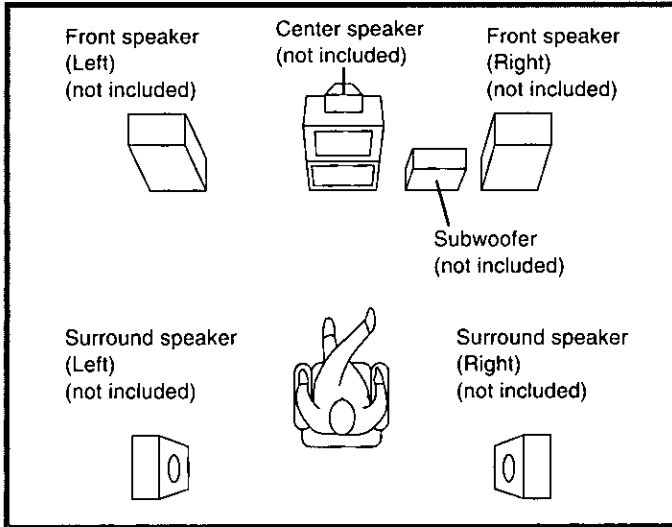

Front speakers

Place the front speakers on the left and right of the TV at seated ear height so there is good coherency between the picture and sound.

Center speaker

Place this speaker underneath or above the center of the TV. Aim the speaker at the seating area.

Surround speakers

Place these speakers on the side of or slightly behind the listener, and about one meter higher than ear level.

Subwoofer

The subwoofer can be placed in any position as long as it is at a reasonable distance from the TV.

Note that some experimentation can yield the smoothest low frequency performance. Placement near a corner can increase the apparent output level, but can result in unnatural bass.

Connecting speakers

Other connections are possible depending on your speaker system. See your speaker system's operating instructions for details.

Front speakers

SA-AX530 This model has only one set of front speaker terminals.

Speaker impedance:

SA-AX730 A or B: 4-8 Ω
A and B: 8 Ω

SA-AX530 8 Ω

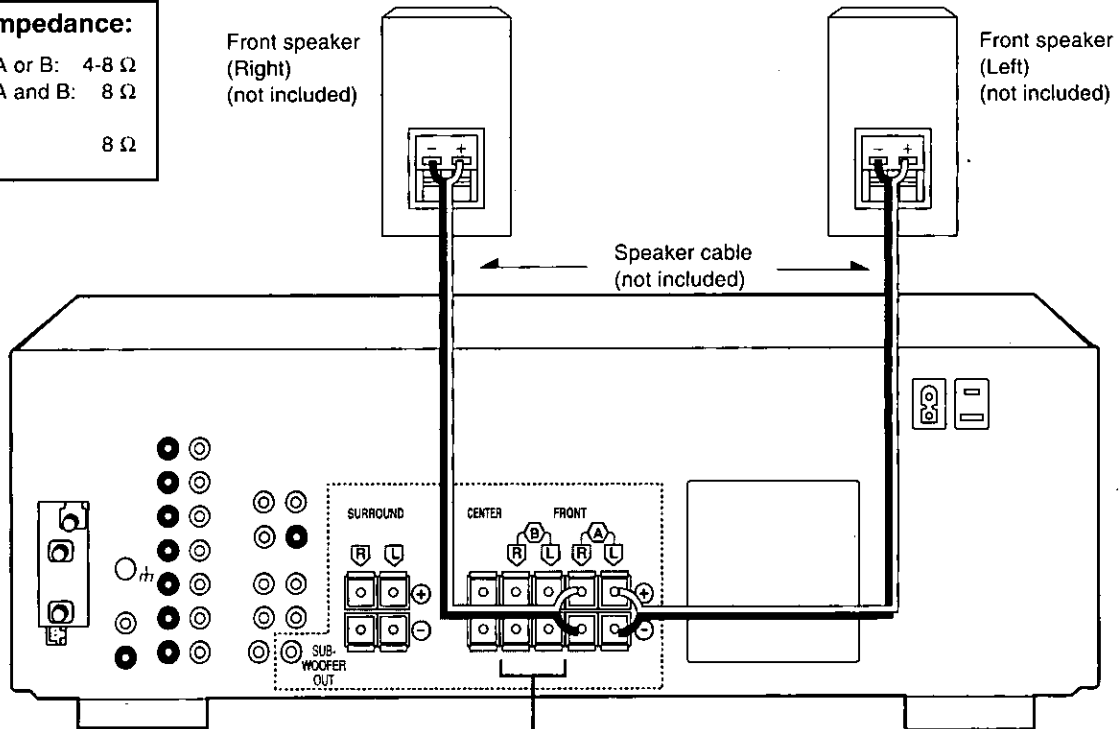

Connecting the cables

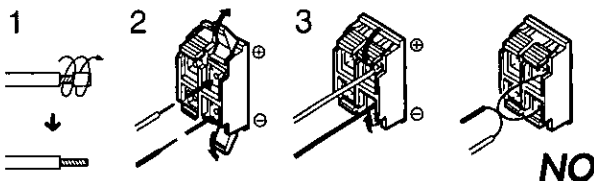

"B" terminals **SA-AX730 only**

For connection to a second pair of speakers.

Note

Use the A terminals to enjoy Dolby Pro Logic, SFC, and DVD 6CH INPUT.

Other speakers

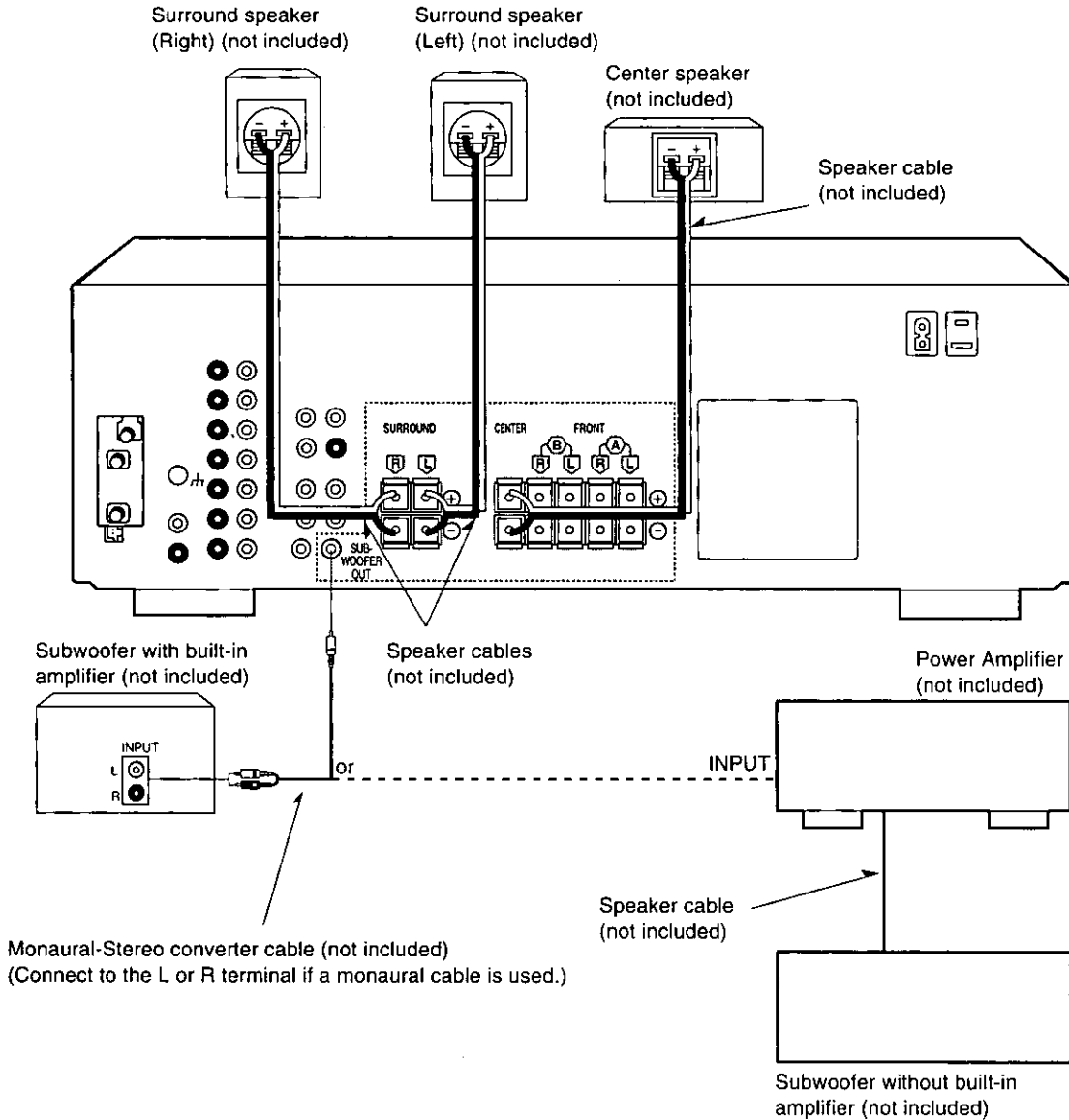

For surround speakers

Note

Do not connect the surround speakers to the front speaker terminals. The surround speakers may be damaged if connected to the front terminals.

Speaker impedance:

Center speaker:	8 Ω
Surround speaker:	8 Ω

For subwoofer

Note

This receiver has no amplifier section designed especially for the subwoofer.

For your reference

Connection to a passive subwoofer with front speaker terminals is also possible. (See the operating instructions of the speaker system for details.)

Basic operations

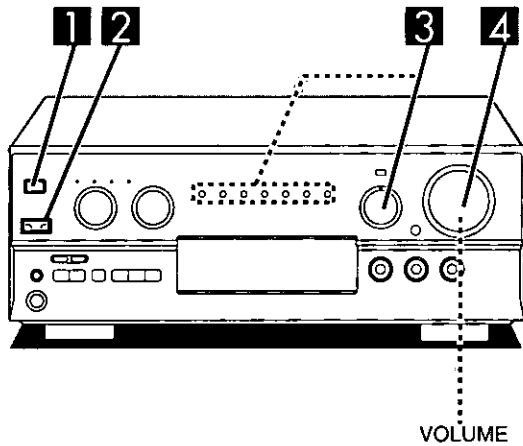

Before operation, set VOLUME to the "MIN" position.

1 Press [POWER].

2 **SA-AX730**

Press [A] and/or [B] to select the speaker system(s) to be used.

A and B refer to the speaker terminals at the rear of the unit.

SA-AX530

Press [SPEAKERS] and check the "SPEAKERS" indication lights up.

If the button is pressed once more, the indicator will switch off and no sound will be heard from the speakers.

3 Turn [INPUT SELECTOR] to select and start the desired source.

(Refer to the appropriate operating instructions for details.)

The indicator which corresponds to the selected input source will illuminate.

The selected source will be shown on the display.

TAPE (MONITOR): To listen to cassette tapes

VCR: To watch video tapes

TV/DSS: To watch TV or DSS

DVD: To watch DVD

CD: To listen to compact discs

TUNER: To listen to radio broadcasts

PHONO: To listen to phono discs

If a Dolby Pro Logic or SFC mode has been selected

After displaying the selected source, the display will then change to show the Dolby Pro Logic or SFC mode.

If the source chosen was TUNER then the display will change again to show the frequency.

Note

To watch a video (or DVD) or the TV, set the TV to either the TV mode or VIDEO mode.

For your reference

If you are using a VCR and you select TAPE, CD, TUNER, or PHONO, the picture will remain on the screen.

4 Adjust the volume.

When you finish listening

Be sure to reduce the volume level, and switch the power to the standby condition by pressing [POWER].

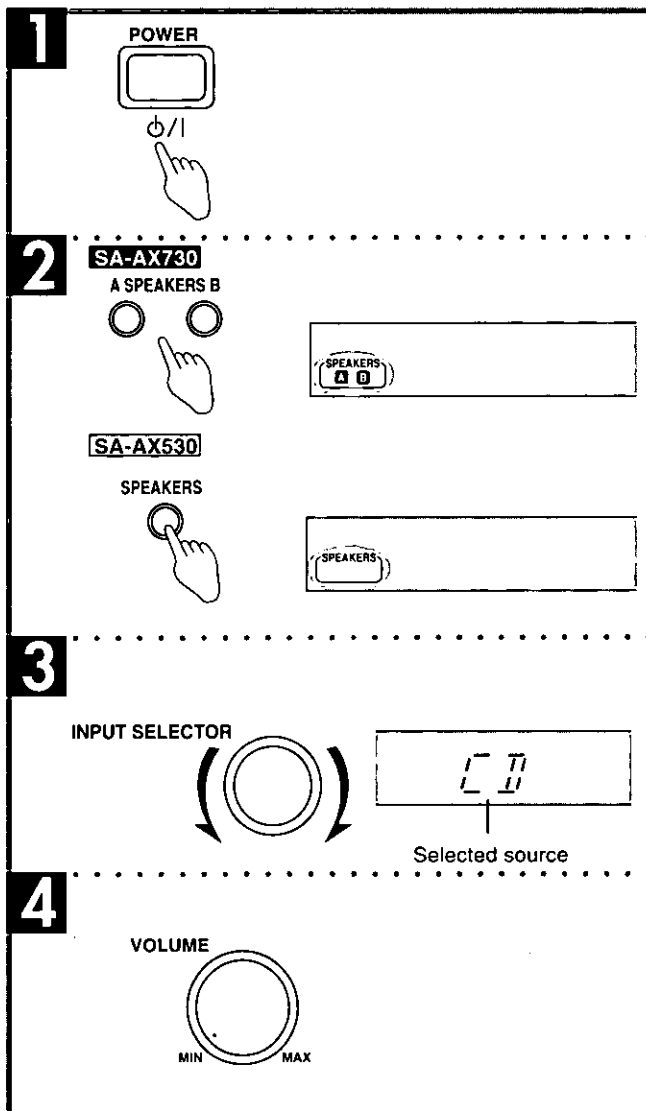

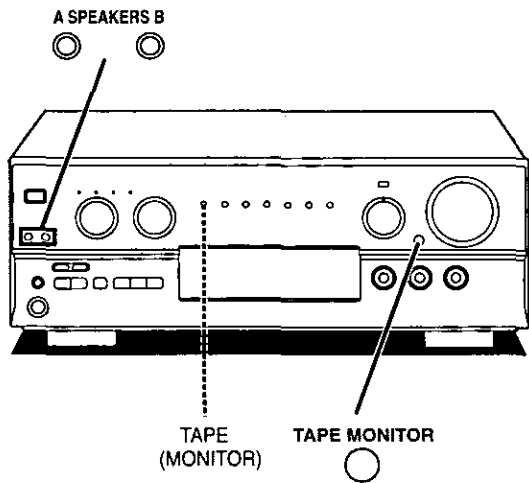

When using speakers under 8 Ω SA-AX730 only **A**

Press and hold [A] or [B] until "LOW IMP" lights up on the display.

If even one of the speakers being used has an impedance under 8 Ω, press and hold down either button A or button B for 4 seconds or more to set the impedance to LOW.

(Press and hold down once again for 4 seconds or more to turn it off.)

Note that when "LOW IMP" is illuminated, speakers **A** and **B** cannot both be used at the same time.

To change a speaker:

e.g. To use speaker **B**, press [A] (**A** goes out), and then press [B] to activate speaker **B**.

Tape monitor **B**

If [TAPE MONITOR] is pressed while a source other than "TAPE (MONITOR)" is selected, the "TAPE (MONITOR)" indicator lights and the tape monitor comes on.

Sources other than tape can still be selected with [INPUT SELECTOR] while the "TAPE (MONITOR)" indicator is on.

Press [TAPE MONITOR] again to turn the tape monitor off.

(➔ See "Recording" on page 30 for details on how to use the tape monitor during recording.)

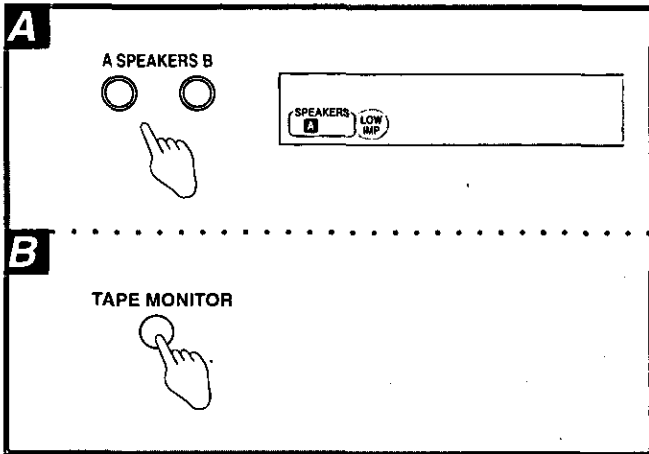

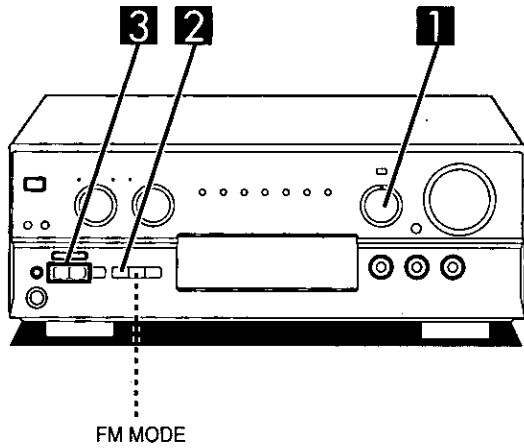

Sequential tuning

Use the tuning buttons to tune-in radio stations.

- 1 Turn [INPUT SELECTOR] to select "TUNER".
- 2 Press [BAND] to select "FM" or "AM".
- 3 Press [TUNING (∨) or (∧)] to tune to the desired frequency.
"QUARTZ LOCK" lights up when tuned.
"STEREO" lights up when an FM stereo broadcast is received.

To make an automatic search for stations

If [TUNING (∨) or (∧)] is held down for an instant until the frequency begins to scroll, the broadcast stations are tuned in automatically when one is found.

Note

Tuning may stop automatically if any jamming is encountered.

If noise is excessive in the FM stereo mode

Press [FM MODE].

("STEREO" will go out, and "MONO" will light up)

The broadcast will be monaural, but noise will be reduced.

If the button is pressed once more, the stereo mode resumes.

For your reference

The tuner can pick up interference from DVD players. If this occurs turn the DVD off.

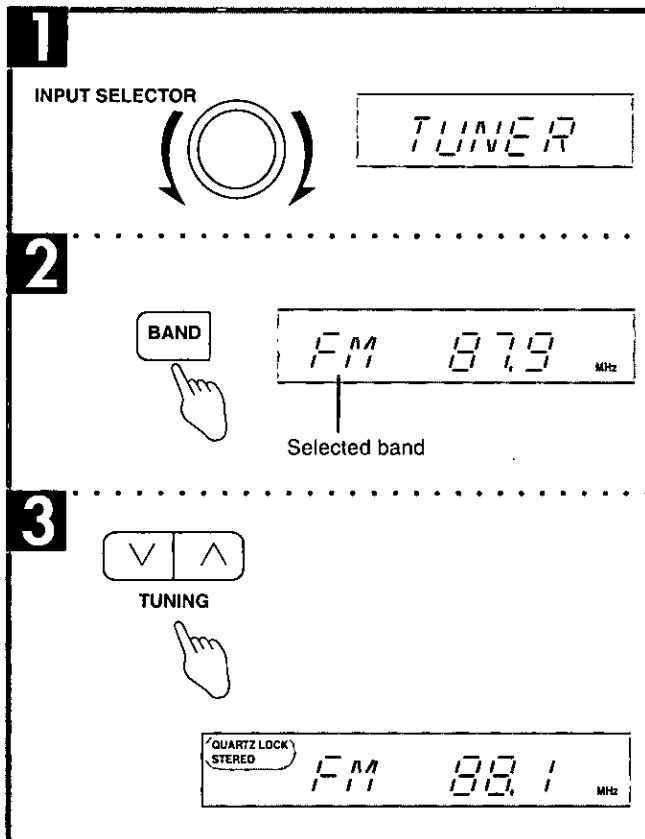

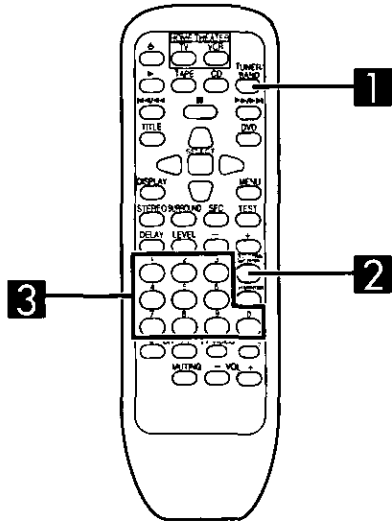

Direct tuning

by remote control only

Specify the frequency using the numeric buttons on the remote control to directly tune to the desired station.

1 Press [TUNER/BAND].

This will set the remote control to operate the tuner. The selector on the receiver will change to "TUNER". Each time the button is pressed, the band will change as follows,
 FM ⇌ AM.

2 Press [DIRECT TUNING/DISC ENTER].

3 While cursor display is flashing (approx. 10 seconds) Press the numeric buttons to enter the frequency.

If the desired FM frequency is 107.9 MHz, press

[1]→[0]→[7]→[9].

If the frequency has been input correctly, the displayed frequency will blink once.

Note

1. If no button is pressed while the cursor display is flashing, the display will return to the frequency which is currently being received. To re-specify the frequency, repeat the procedure from step 2.
2. If the frequency has not been input correctly, "ERROR" will be displayed. In this case, re-enter the frequency.

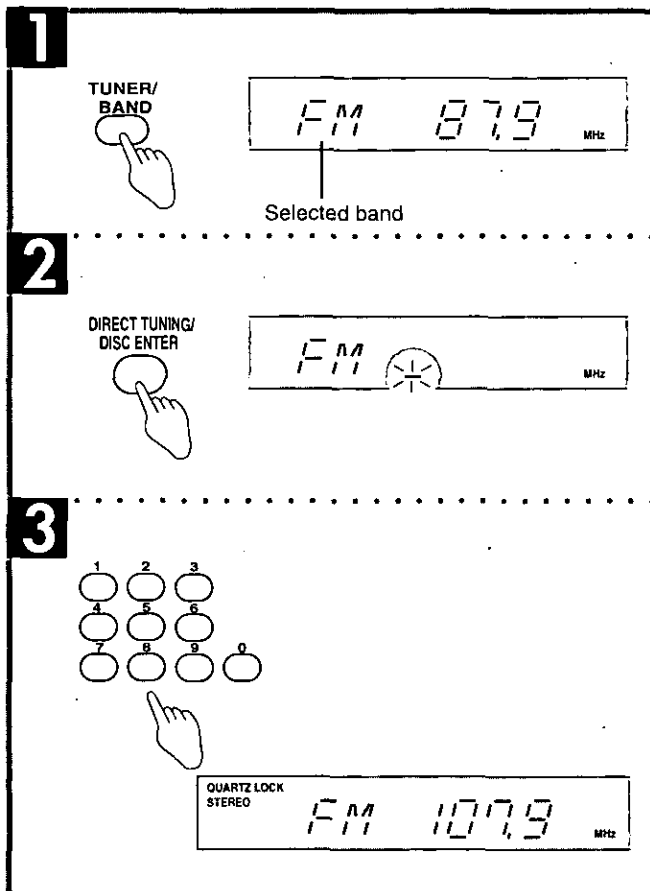

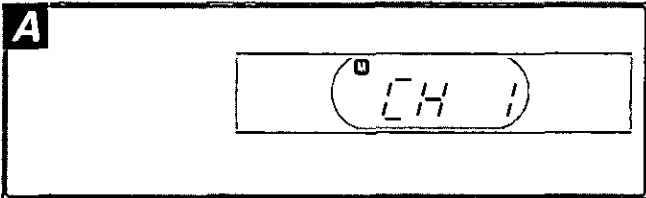
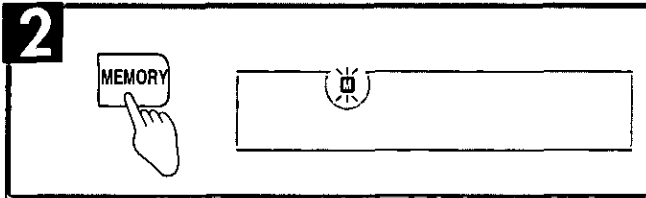
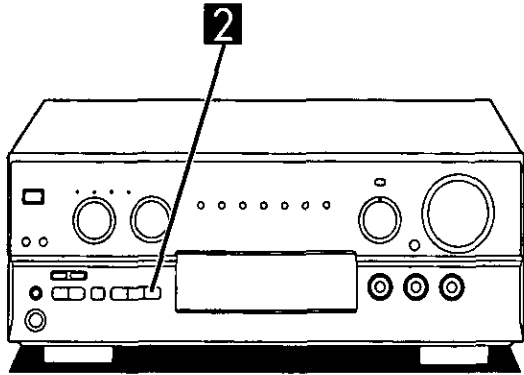

Preset tuning

Presetting radio stations into the memory channels of this unit makes selecting stations simple.

A total of 30 FM and AM stations can be preset.

Please remember this

If a new broadcast station is preset into a channel, the setting for the broadcast station which was previously entered in that channel will be automatically erased.

Automatic memory presetting

Automatic memory presetting allows this unit to automatically search for broadcast stations and then preset them into memory. With this method, the channels that can be preset into the memory are set as follows for different bands (FM or AM).

When FM stations are preset,

For FM stations 1-30

When FM and AM stations are preset,

For FM stations 1-20

For AM stations 21-30

1 Set to the frequency from which you want to start automatic memory presetting.
(→ Page 18-19.)

2 Press [MEMORY] until the frequency begins to change.

(Automatic memory presetting will start.)

During automatic memory presetting, the memory indicator will flash while the frequency scrolls.

To stop, press [MEMORY] once again.

When a broadcast station is preset

The memory indicator and the preset channel number will be displayed for approximately 1 second.

When presetting is completed

The last broadcast station to be preset will be displayed.

Note

Frequencies may not be preset correctly in cases where the broadcast waves are too strong or too weak. In such cases, carry out presetting manually. (→ Page 21.)

A

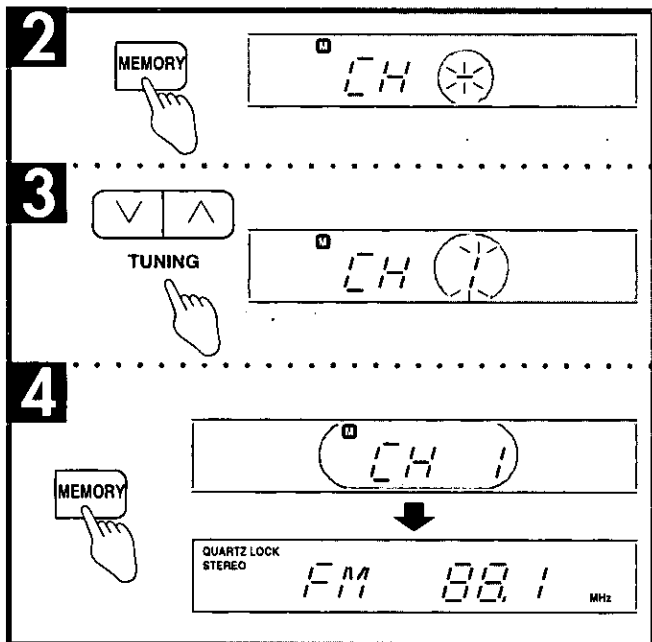
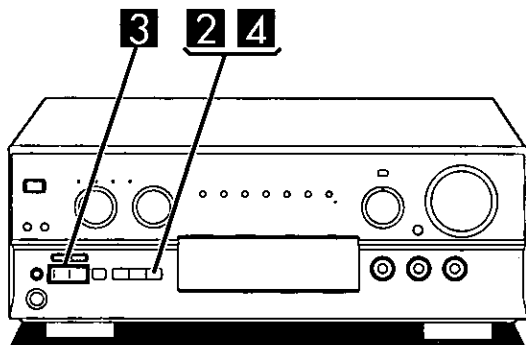

B

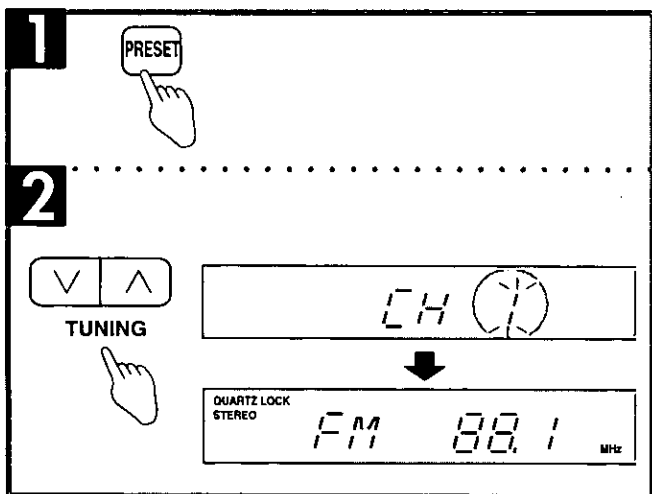
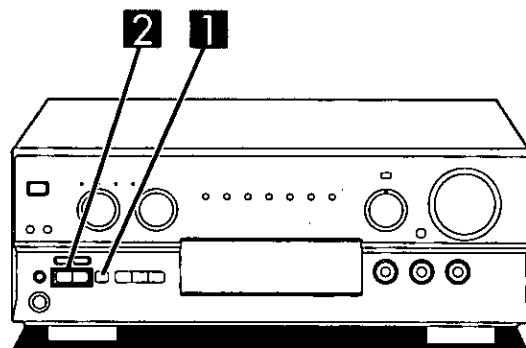

Manual memory presetting A

The desired stations can be preset into the desired channels by the user.

1 Set to the desired frequency.
(→ Page 18–19.)

If interference or static is keeping you from enjoying an FM broadcast, press [FM MODE] and change to monaural. You can preset the station in monaural just as in stereo.

2 Press [MEMORY].
To cancel the memory function, press [MEMORY] again.

3 Press [TUNING (∨) or (∧)] to select the desired channel.
Holding the buttons down lets you scroll through channels faster.

4 Press [MEMORY].
The channel will blink on the display.

To continue presetting
Repeat steps 1 through 4.

To listen to preset channels B

1 Press [PRESET].

2 Press [TUNING (∨) or (∧)].
Holding down the buttons lets you scroll through channels faster.

The channel number will be changed for approximately 5 seconds. Select the desired channel number during that time. After 5 seconds, the display will change from the channel number to the frequency.

Note

If you press [PRESET] while the channel number is displayed, the display will change to the frequency.

To confirm the channel number of the broadcast station being received

Press [PRESET].
(The channel number will be displayed for approximately 5 seconds.)

Note

The channel number is not displayed if you change the frequency or FM mode setting.

For your reference

Even if the power cord is disconnected from the household AC outlet, the memory will retain its contents for approximately one month.

If frequency presettings are accidentally erased

Program the presettings once again.
The power cord should remain connected for one hour or more for the memory back-up to be effective.

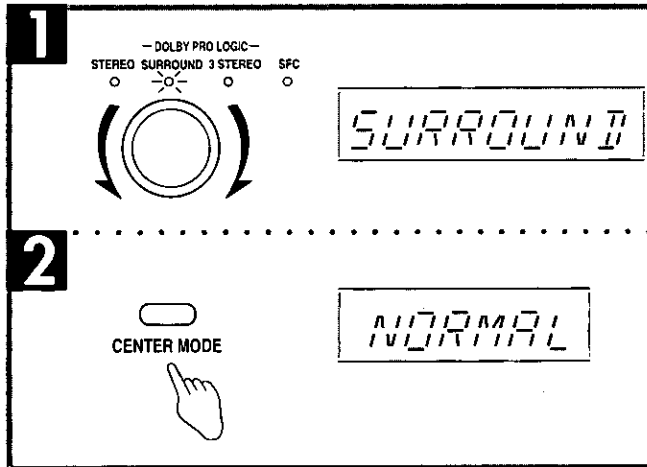
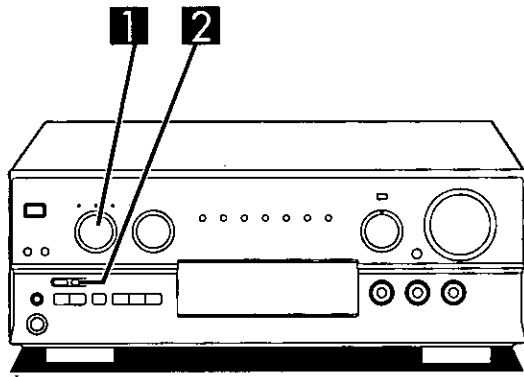

Setting the center mode and adjusting speaker output level

- When ready to adjust speaker output level, situate yourself where you would normally be listening.
- First turn ON the speakers with [SPEAKERS A (or SPEAKERS)] on the receiver.
- If front speaker volume is unbalanced, adjust the balance with [BALANCE].

SA-AX730 only

Note

Ensure the front speakers are connected to the A terminals when you use Dolby Pro Logic. The Dolby Pro Logic modes cannot be turned on if "SPEAKERS B" is selected.

The following steps are for setting the output level of the front speakers and the center/surround speakers to the same listening level.

- 1 Turn the sound mode selector to select "SURROUND".

Note

1. Select "3 STEREO" if surround speakers have not been connected.
2. Remember you cannot adjust the output level of the surround speakers if you selected "3 STEREO" mode.

- 2 Press [CENTER MODE] to select the correct center mode.

When the button is pressed, the current center mode is displayed. Pressing it again changes the center mode.

NORMAL

When the center speaker is smaller than the front speakers.

WIDEBAND

When the center speaker is the same size as or larger than the front speakers.

PHANTOM **SURROUND mode only**

When no center speaker is connected.

Note

In the PHANTOM mode, the sound which would have been sent to the center speaker will be divided equally between both the left and right front speakers.

(Continued on next page)

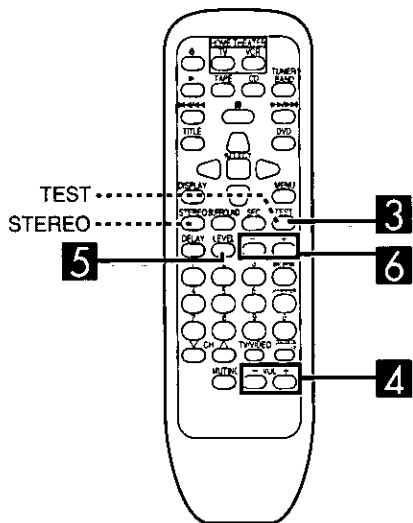

3 by remote control only

Press [TEST] to output a test signal.

The speaker outputting the test signal is displayed while the test is running.

- L : Front speaker (Left)
- C : Center speaker
- R : Front speaker (Right)
- S : Surround speakers

The subwoofer is muted while testing.

In the PHANTOM mode, the center speaker is OFF, so there is no center test signal and "C" is not displayed.

4 by remote control

Press [VOL (-) or (+)] to set the volume level normally used for enjoying the source.

5 by remote control only

Press [LEVEL] to select the center or surround speakers.

6 by remote control only

Press [-] or [+] to adjust the output level.

Adjust the output level of each speaker from the listening position until they are all identical.

-: Decrease the output level.

+: Increase the output level.

Output level can be varied within a range of -12 dB to +12 dB with front speaker output level serving as the zero point.

Note

During steps 5 and 6 above the test signal sequence is interrupted and the signal will only come from the selected speaker.

The sequence will resume when adjustments are stopped.

To stop the test signal

Press [TEST].

To turn off the Dolby Pro Logic systems

Press [STEREO].

3

4

5

6

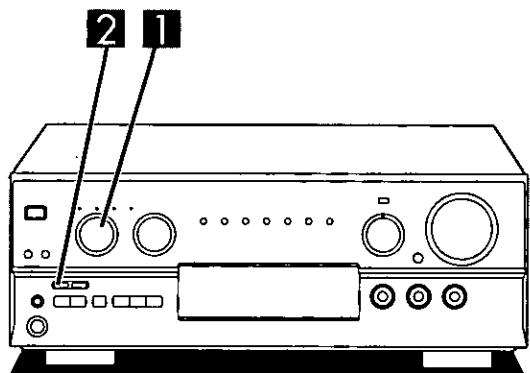

Adjusting the delay time

When enjoying with SURROUND only

Adjust the sound from the surround speakers until the proper effect is produced.

1 Turn the sound mode selector to select "SURROUND".

2 Press [DELAY TIME] to set the time.

When the button is pressed, the current delay time is displayed.

Each time the button is pressed, the delay time will increase by 5 ms within a range of 15 ms to 30 ms.

The standard setting is 20 ms.

To calculate the delay time

D_1 : Distance from front speakers

D_2 : Distance from surround speakers

• If D_1 is equal to or less than D_2

Set to 15 ms.

• If D_2 is less than D_1

Start at 15 ms and increase by 5 ms for every 1.5 m of difference between D_1 and D_2 .

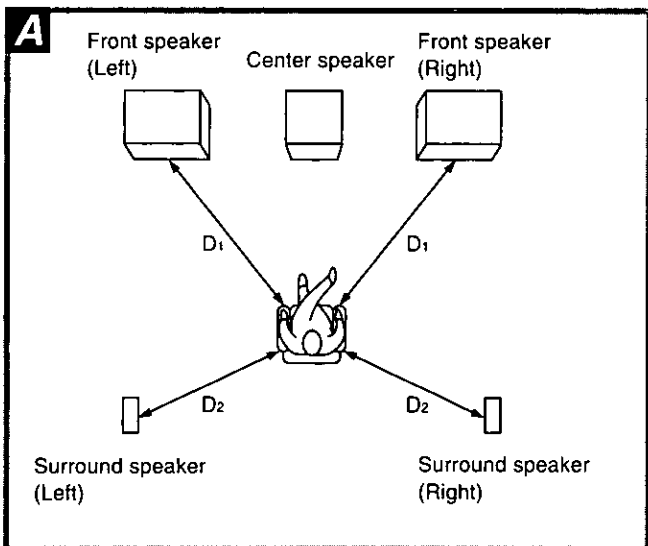
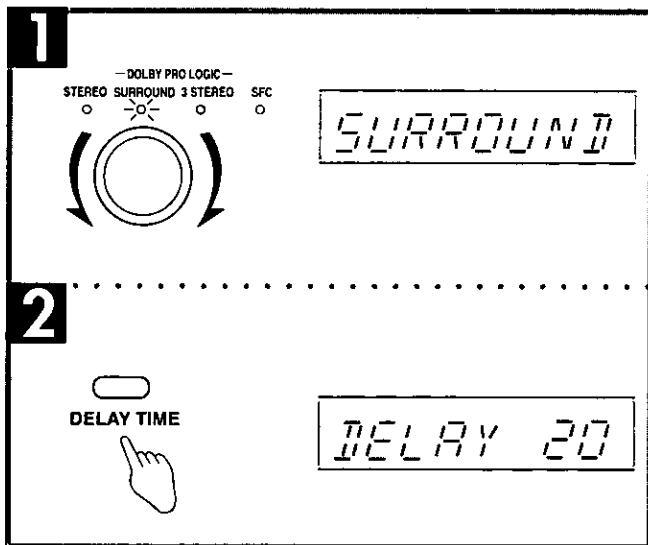

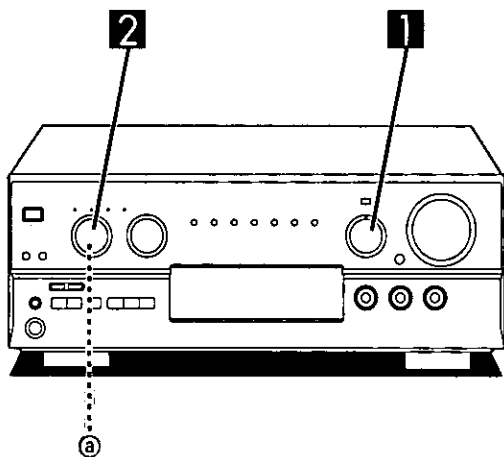

Enjoying SURROUND or 3 STEREO

- 1** Turn [INPUT SELECTOR] to select and start the desired source.
- 2** Turn the sound mode selector to select "SURROUND" or "3 STEREO".

Note

When employing SURROUND, use software recorded in Dolby Surround.

For your reference

You can set the Dolby Pro Logic mode for each source. Each source will retain the selected mode.

To turn off the Dolby Pro Logic systems

Turn the sound mode selector (a) to select "STEREO".

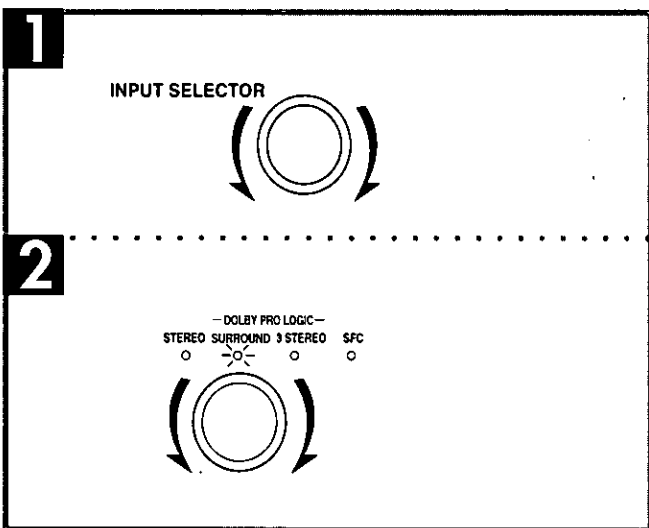

Manufactured under license from Dolby Laboratories Licensing Corporation.
 Dolby, the double-D symbol  and "PRO LOGIC" are trademarks of Dolby Laboratories Licensing Corporation.

SFC (Sound Field Control)

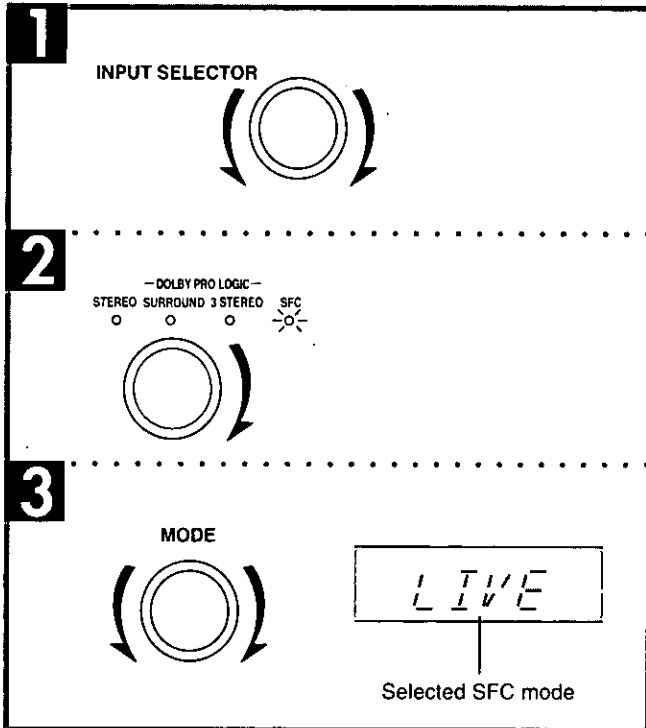
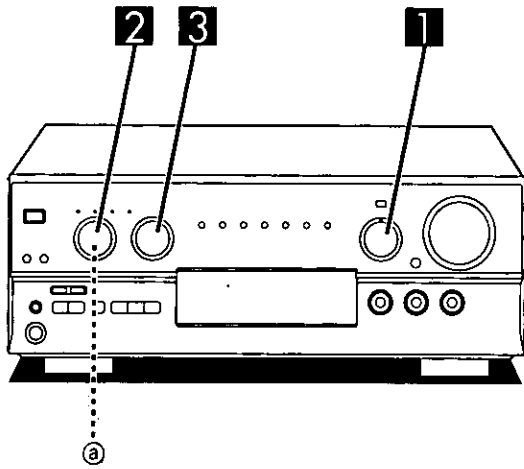

The SFC function gives presence and spread thereby enhancing and enriching the music or movie.
Read the following explanations in order to better understand how to make your selection.

Note

The center speaker is not used in the hall, and simulated modes.

HALL

This mode imparts a reflection and spread which will make you feel as if you are in a large concert hall.

CLUB

Like a jazz club, this mode provides an exciting and intimate atmosphere. It simulates the sound field of a relatively small room having a low ceiling and hard reflective surfaces, for a "live" sound with enhanced presence to bring the performers up close.

LIVE

Primarily for vocal pieces, this mode adds gloss to the vocals and you'll feel as though you were hearing a live stage performance.

THEATER

You can clearly perceive the directions and source of the movie. Real ambience of sound can also be recreated naturally using this mode.
THEATER mode can be used with stereo sources not encoded with Dolby Surround.

Note

When using Dolby Surround encoded materials, select "SURROUND".

SIMULATED (SIM SURR)

Choose this mode if little or no sound will be heard from the surround speakers.
You can feel as if you were in a more expanded space adding to the actual sound from the source.
This mode also adds effect to monaural sources by outputting sound from surround speakers.

1 Turn [INPUT SELECTOR] to select and start the desired source.

2 Turn the sound mode selector to select "SFC".

3 Turn [MODE] to select the desired SFC mode.

Note

The SFC mode can also be selected by directly turning [MODE] in step 2 instead of selecting "SFC".

For your reference

You can set the SFC mode for each source.
Each source will retain the selected mode.

To turn off the SFC function

Turn the sound mode selector (ⓐ) to select "STEREO".

SA-AX730 only

Note

Ensure the front speakers are connected to the A terminals when you use SFC.
The SFC modes cannot be turned on if "SPEAKERS B" is selected.

A

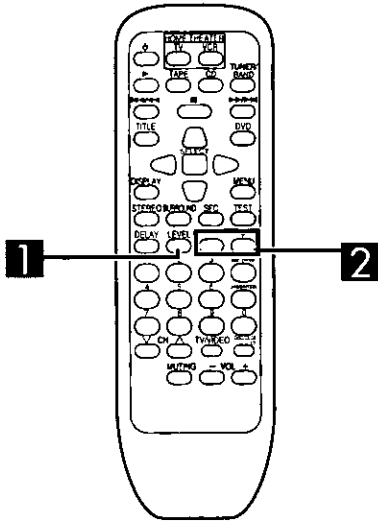

Adjusting field of sound

With this unit, you can adjust speaker volume. Adjust the field of sound while listening to a source.

To adjust the volume of the center and surround speakers **A**

by remote control only

1 Press [LEVEL] to select the center or surround speakers.

Note

You can adjust the center speaker volume only in the theater mode.

2 Press [+] or [-] to adjust the output level.

To adjust the delay time **B**

Press [DELAY TIME] to set the time.

When the button is pressed, the current delay time is displayed. Each time the button is pressed, the delay time will change.

The delay time increments are different depending on the SFC mode.

Select a delay time setting to accommodate to your individual needs.

SFC modes	Available delay time setting (ms)
HALL	20, 25, 30, 40 , 50
CLUB	0, 15 , 20, 25, 30
LIVE	15, 20, 30, 40, 50
THEATER	15, 20 , 25, 30, 40
SIMULATED	15 , 20, 25, 30, 40

The figures in bold italics are the factory settings.

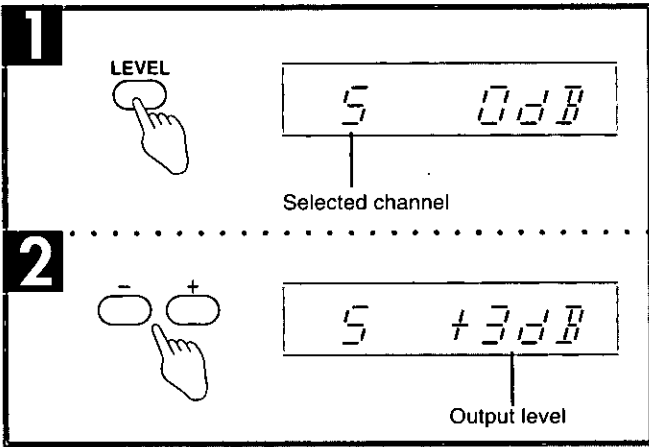

B

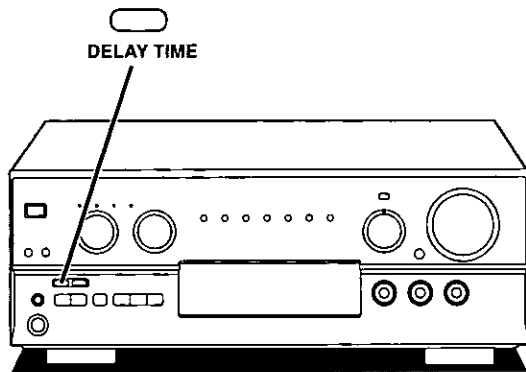

DVD 6CH INPUT mode

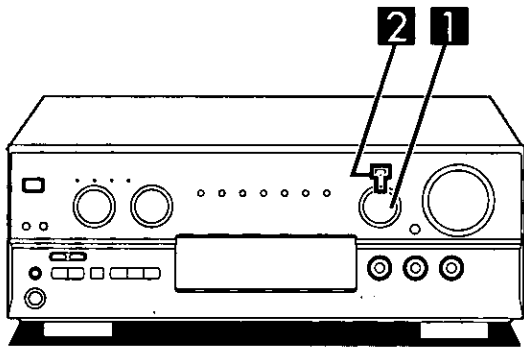

This receiver can playback 6 channel discrete sound. It has terminals for connecting to a component with 6 channel discrete output, such as a DVD player.

6 channel discrete output makes playback sound more real by adding depth, movement, position and other characteristics to the field of sound.

It will make you feel as if you were at the movie theater when in your own home.

To enjoy 6 channel discrete output sound

You have to connect a DVD player, Digital Surround Processor or other component that has 6 channel discrete output capabilities.

(➔ Page 9, 11.)

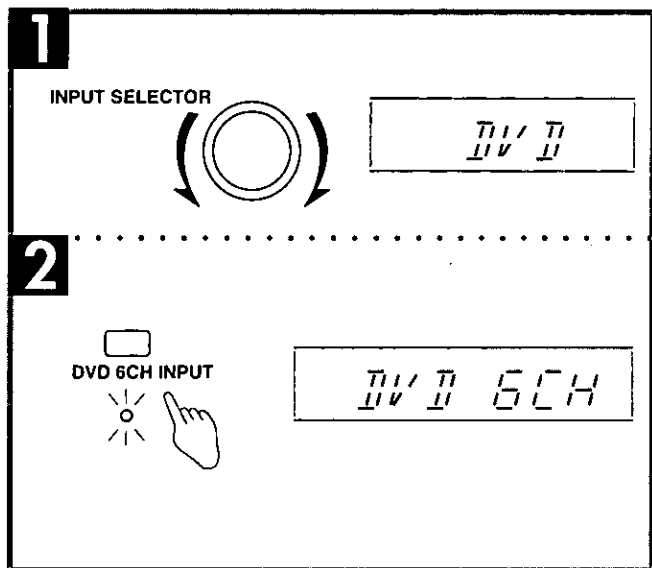

1 Turn [INPUT SELECTOR] to select "DVD".

2 Press [DVD 6CH INPUT] to select "DVD 6CH".

Changes as follows, each time the button is pressed.
DVD 6CH ⇌ DVD (2CH)

The "DVD 6CH INPUT" indicator lights when "DVD 6CH" is selected.

If you press this button while another source (CD, PHONO, etc.) is selected, the receiver switches the source to DVD and engages the DVD 6CH INPUT mode.

3 Start the desired source.

Follow your equipment's operating instructions.

Note

You cannot select Dolby Pro Logic or any of the SFC modes while in the DVD 6CH INPUT mode.

SA-AX730 only

Note

Ensure the front speakers are connected to the A terminals when you use DVD 6CH INPUT mode. The DVD 6CH INPUT mode cannot be turned on if "SPEAKERS B" is selected.

Other functions

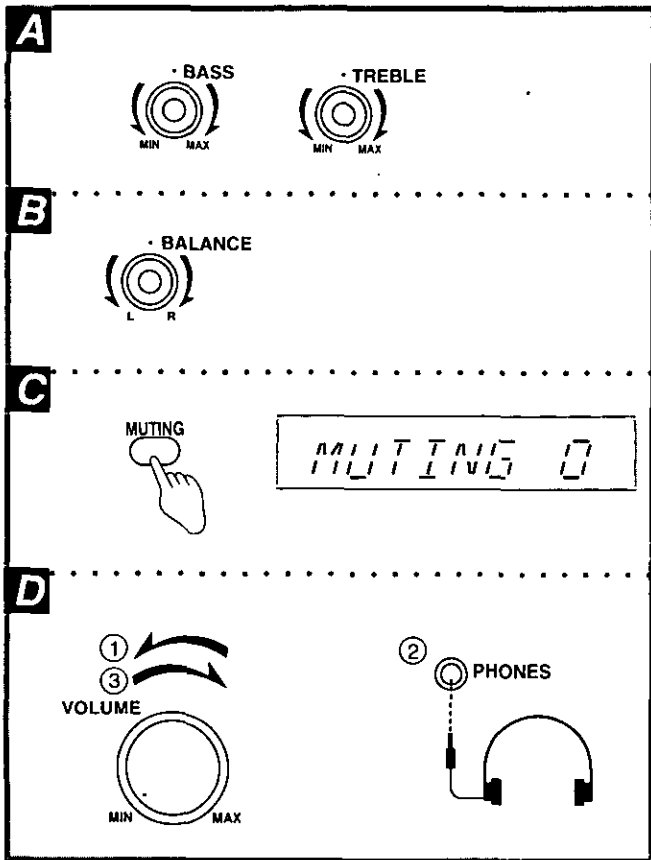
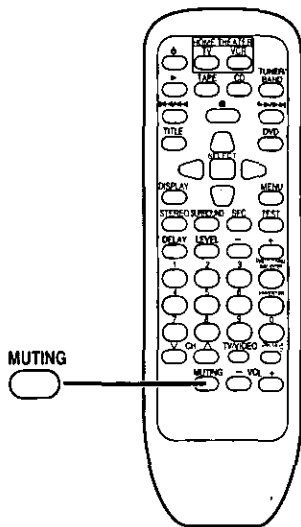
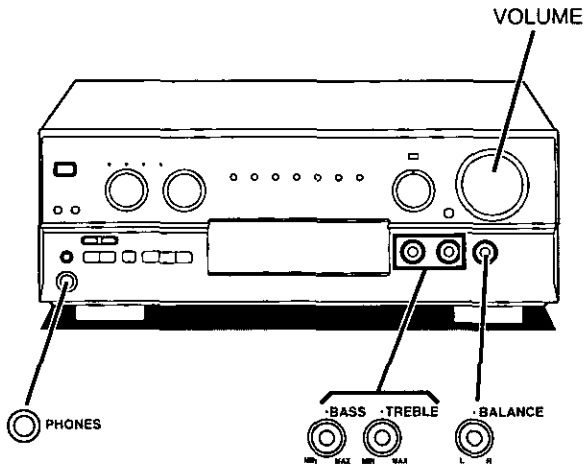

To adjust the tone quality **A**

Turn [BASS] to adjust the low frequency sound. Turn [TREBLE] to adjust the high frequency sound.

To adjust the sound balance **B**

Turn [BALANCE] to adjust the left/right sound balance.

To mute the sound level **C**

by remote control only

Press [MUTING].

The message "MUTING ON NOW" runs repeatedly from right to left across the display as long as the muting function is on.

Press once again to return to the previous volume level.

Note

When the receiver is turned off, the muting operation will be automatically cancelled.

To listen through headphones **D**

- ① Reduce the volume level.
- ② Connect the headphones.
Plug type: 6.3 mm (1/4 in.) stereo
- ③ Adjust the volume level.

If you do not want sound from the speakers, press [SPEAKERS] button(s) and check the speaker indicator(s) goes out.

If a subwoofer is connected to your system, turn off the power to it (or the subwoofer amp you are using) or lower the volume to the minimum level.

Note

Avoid listening for prolonged periods of time to prevent hearing damage.

Making a recording

A

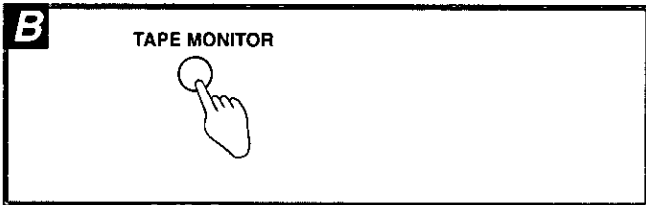
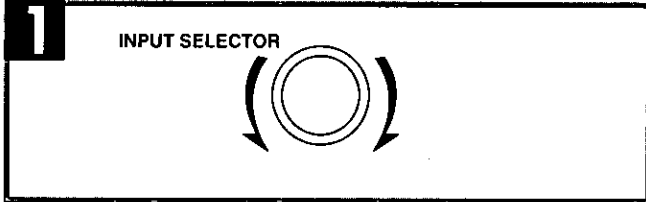
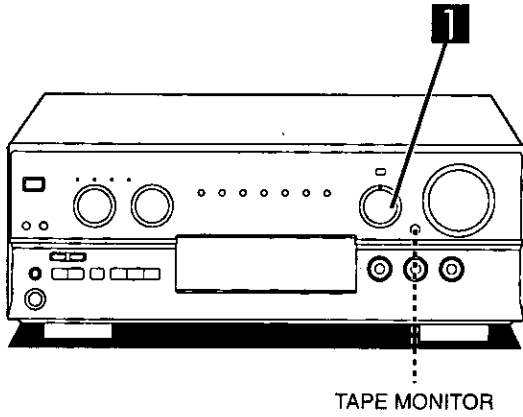

C

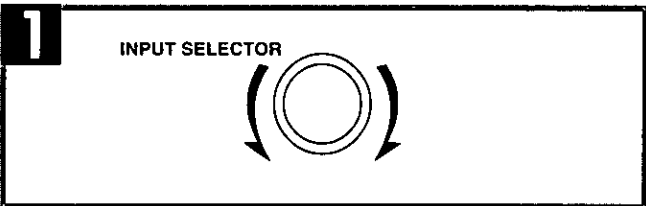
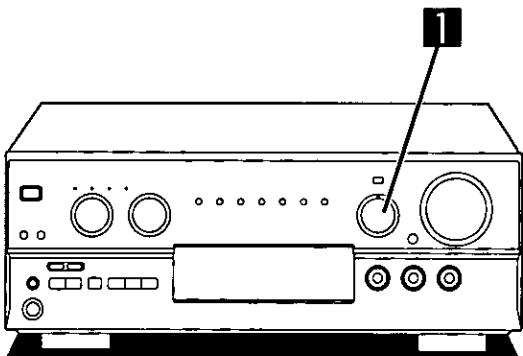

Recording on a tape deck **A**

Before recording, prepare the tape deck for recording. See the tape deck's operating instructions for details.

1 Turn [INPUT SELECTOR] to select the source to be recorded.
Any source can be selected except TAPE.

2 Begin recording on the tape deck.
Follow your tape deck's operating instructions.

3 Begin the source to be recorded.
Follow your equipment's operating instructions.

To check the sound recorded while a recording is being made **B**

It is possible to check the sound being recorded if your tape deck is a 3 head system.

Press [TAPE MONITOR] on this unit and set the monitor button on the tape deck to "TAPE".

Press [TAPE MONITOR] once again to turn it off.

Recording on a VCR **C**

Before recording, prepare VCR for recording. See the VCR's operating instructions for details.

1 Turn [INPUT SELECTOR] to select the source to be recorded.
Any source can be selected except VCR and TAPE.

Note
Recording from the tape deck is not possible.

2 Begin recording on the VCR.
Follow your VCR's operating instructions.

3 Begin the source to be recorded.
Follow your equipment's operating instructions.

Note
When you select DVD 6CH INPUT mode, only sound from the front left and right speakers is recorded.

To record all 6 channels
Set the playback mode on your DVD player or decoder to 2 channel (stereo) mode.

For details, see the instruction manual that came with the connected equipment.

To operate the receiver

Point the remote control toward the receiver

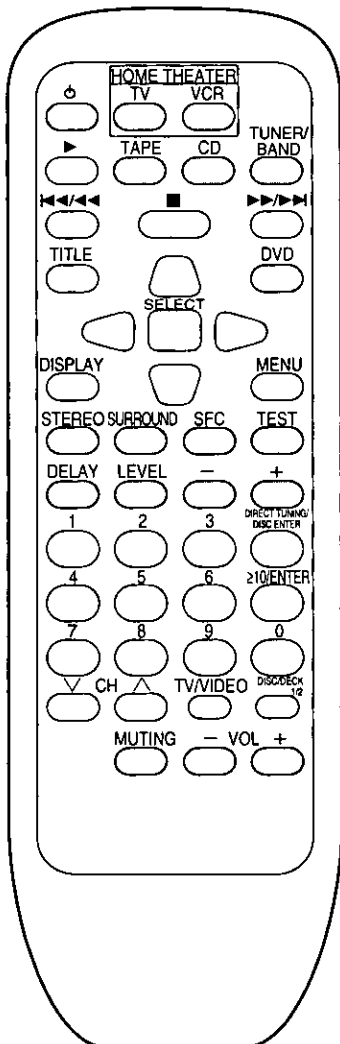

Basic operations

To turn the unit ON/OFF



Once the unit has been set to ON, it can be turned ON and OFF simply by pressing [⏻].

Note

After turning the TV, VCR or DVD player ON or OFF, always press TUNER/BAND before pressing [⏻] when turning the receiver ON and OFF.

To select an input source and switch the remote control transmitter to each operation mode



Note

PHONO can not be selected with this remote control.

To turn off the Dolby Pro Logic and SFC mode



To turn on the Dolby Pro Logic and select the SURROUND mode



Note

3 STEREO can not be selected with this remote control.

To turn on the SFC function and select the desired mode



Changes as follows each time the button is pressed.

HALL — CLUB — LIVE — THEATER
└ SIM SURR (SIMULATED) ┘

To output a test signal



When the SURROUND or 3 STEREO mode is ON

Press once more to stop the signal.

To adjust the output level of the center speaker and/or surround speakers



- ① Select center (C) or surround (S).
- ② Adjust output level.

- When the SURROUND mode is ON and the center mode is on PHANTOM, you cannot select the center channel.
- When SFC is used, the center mode can be changed only if THEATER is on.
- When the 3 STEREO mode is ON, you cannot select the surround channel.

To adjust the delay time



When the SURROUND or SFC mode is ON

To mute the sound level



The message "MUTING ON NOW" runs repeatedly from right to left across the display as long as the muting function is on.







Press once more to return to the original volume.

To adjust the volume level

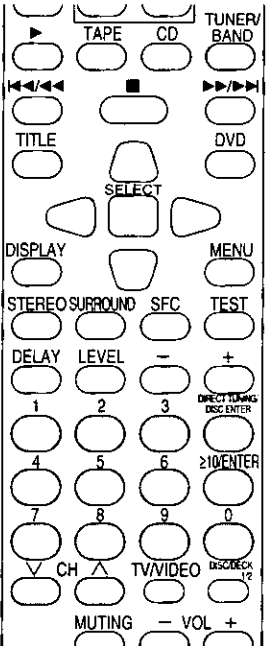

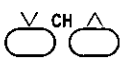
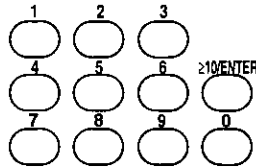
To operate the receiver (continued)

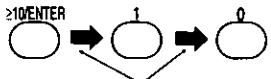
Make sure the remote control is in the tuner operation mode. (⇒ Page 31.)

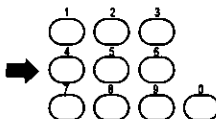
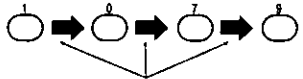



<p>Point the remote control toward the receiver</p>  	<h3>To listen to radio broadcasts</h3>	
	<p>To select "FM" or "AM"</p> 	<p>Change as follows each time the button is pressed. FM ⇄ AM</p>
	<p>To select the desired channel sequentially (Preset tuning)</p>	
	<p>To select the desired channel directly (Preset tuning)</p>	 <p>(Example: Channel 1) </p> <p>(Example: Channel 10) </p> <p>≥10/ENTER is ≥10 on SA-AX530 within 10 seconds</p>
<p>To select radio stations by frequency (Direct tuning)</p>	  <p>(Example: 107.9MHz) </p> <p>within 10 seconds</p>	

To operate a cassette deck

Turn the cassette deck ON before trying to operate it by remote control.

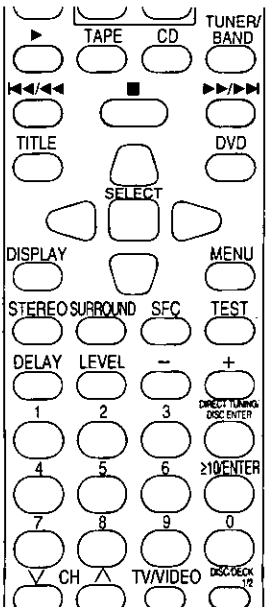





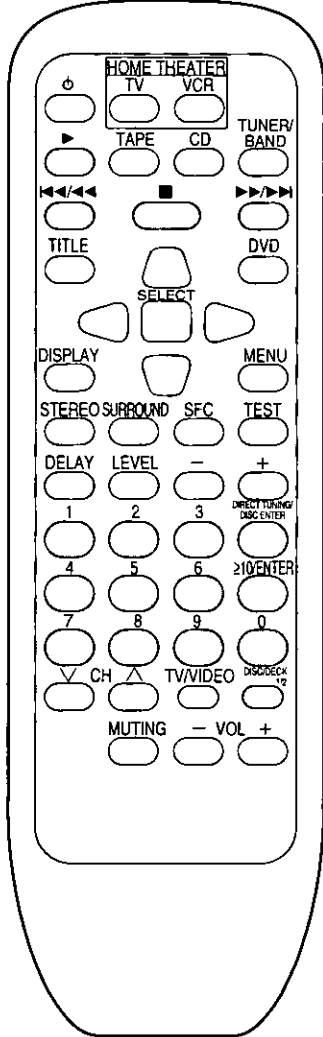

Make sure the remote control is in the cassette deck operation mode. (⇒ Page 31.)

It may not be possible to operate some cassette decks with this unit.

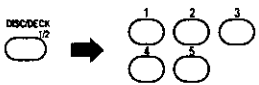
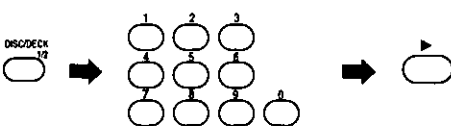
<p>Point the remote control toward the cassette deck</p>  	<p>Only when using a double cassette deck</p> <p>To select the tape deck (DECK 1/DECK 2)</p> 
	<p>To start playback</p> 
	<p>While the tape is stopped</p> <p>To fast-forward or rewind the tape</p>  <p>With TPS-equipped cassette decks, you can move to the beginning or end of a track by pressing these buttons while the tape is playing.</p>
	<p>To stop playback</p> 

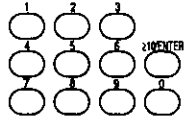
To operate a CD changer or CD player

Turn the CD changer (or CD player) ON before trying to operate it by remote control.
 Make sure the remote control is in the CD player operation mode. (➔ Page 31.)
 It may not be possible to operate some CD players with this unit.

<p>Point the remote control toward the CD changer (or CD player)</p>  	<p>To start play</p> 		
	<p>To start play from the desired disc</p>	<p>For 5 CD changer</p>  <p>Select disc number.</p>	<p>For MEGA CD changer ※</p>  <p>Select the disc number. (When selecting discs, [≥10/ENTER] does not respond to touch.) ≥10/ENTER is ≥10 on SA-AX530.</p> <p>For your reference</p>  <p>If you press this button instead of [▶] shown in the above procedure, the CD changer will stop and display the disc number. To start the disc, press [▶].</p>
	<p>To start play from the desired track</p>	 <p>Select the track number. (Example: Track 1) (Example: Track 10) ≥10/ENTER → 1 → 0</p> <p>≥10/ENTER is ≥10 on SA-AX530.</p>	<p>Select the track number. (Example: Track 1) (Example: Track 10) ≥10/ENTER → 1 → 0</p>
	<p>To skip a track</p>		
<p>To stop play</p>			

※ "MEGA CD changer" means any Technics CD changer that takes more than 50 discs.

To watch TV broadcasts

The procedure below are examples for when a TV and VCR are connected to the receiver as shown in this manual. This remote control transmitter is designed for home theater system. If you press [TV] (or [VCR]) and [⏻] in succession, the TV (or VCR) and receiver will be turned on and the selector on the receiver will change to TV/DSS (or VCR). Press [⏻] within 3 seconds of pressing [TV] (or [VCR]).

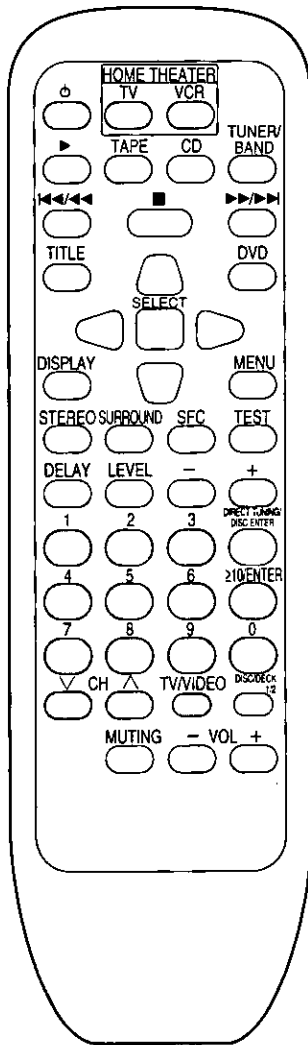

To watch TV broadcasts

Point the remote control toward the TV and the receiver



Switch ON the TV and the receiver.

Point the remote control toward the TV



Set the TV/VIDEO mode on the TV to "TV".

Point the remote control toward the TV

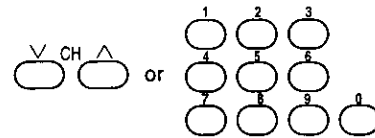

Select the desired channel.

The receiver will switch the input source to TV/DSS.

Note

If you allow more than 3 seconds to pass between pressing [TV] and [⏻], only the TV will be operated.

Do not use this remote control to turn the TV ON and OFF if you are not using the receiver .

To watch TV broadcasts with a VCR tuner

Point the remote control toward the TV and the receiver



Switch ON the TV and the receiver.

Point the remote control toward the VCR and the receiver



Switch ON the VCR.

The receiver will switch the input source to VCR.

Set the input selector on the VCR to the "TUNER" position

Point the remote control toward the VCR

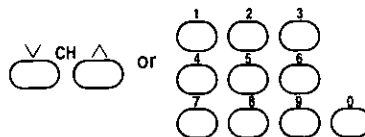

Select the desired channel.

Point the remote control toward the TV

Set the TV/VIDEO mode on the TV to "VIDEO".

Note

If you allow more than 3 seconds to pass between pressing [VCR] and [⏻], only the VCR will be operated.

Do not use this remote control to turn the VCR ON and OFF if you are not using the receiver .

To switch OFF the TV



To switch OFF the VCR



Note

Turn the the receiver OFF last.



SA-AX730 only

This button is used when using ENTER to select a channel on a TV or VCR which has not been manufactured by this company.

To watch video tapes

The procedures below are examples for when a TV and VCR are connected to the receiver as shown in this manual.

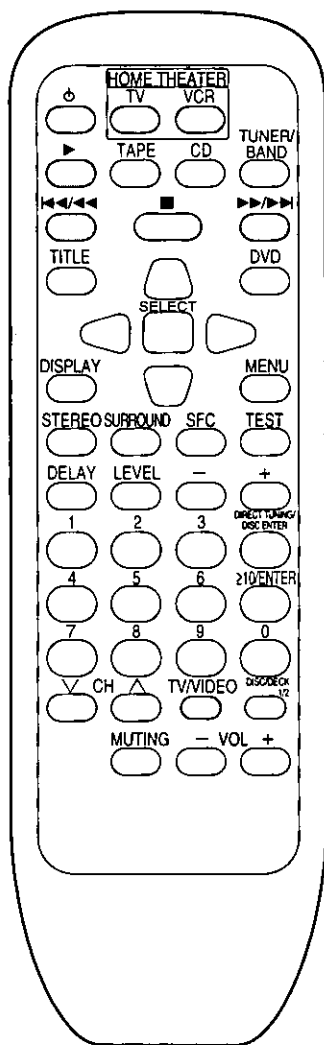

To watch video tapes

Point the remote control toward the TV and the receiver



Switch ON the TV and the receiver.

Point the remote control toward the VCR player and the receiver

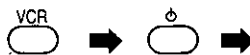

Switch ON the VCR player.

Point the remote control toward the TV



Set the TV/VIDEO mode on the TV to "VIDEO".

The receiver will switch the input source to VCR.

Point the remote control toward the VCR player



Playback will begin.

To fast-forward or rewind the video tape

In the stop mode



To stop playback



To switch OFF the TV



To switch OFF the VCR



Note

Turn the receiver OFF last.

To operate a DVD player

The procedures below are examples for when a TV and DVD player are connected to the receiver as shown in this manual.

Make sure the remote control is in the DVD player operation mode. (➔ Page 31.)

Actual operations depend on your equipment and software.

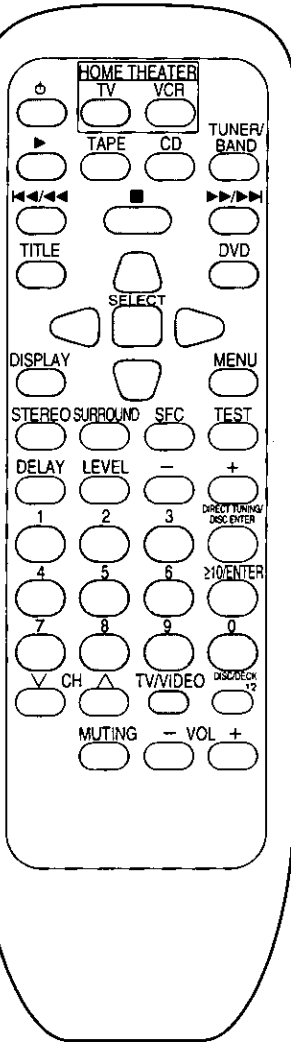

To watch DVDs

Point the remote control toward the TV and the receiver



Switch ON the TV and the receiver.

Point the remote control toward the DVD player and receiver



Switch ON the DVD player.
The receiver will switch the input source to DVD.

Point the remote control toward the TV



Set the TV/VIDEO mode on the TV to "VIDEO".

Point the remote control toward the DVD player.



Play will begin.

To select the title

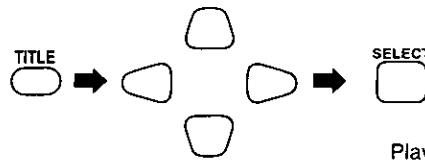

Play will begin.

To use the DVD menu

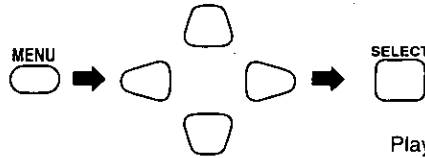

Play will begin.

To clear the DVD menu



To select the scene

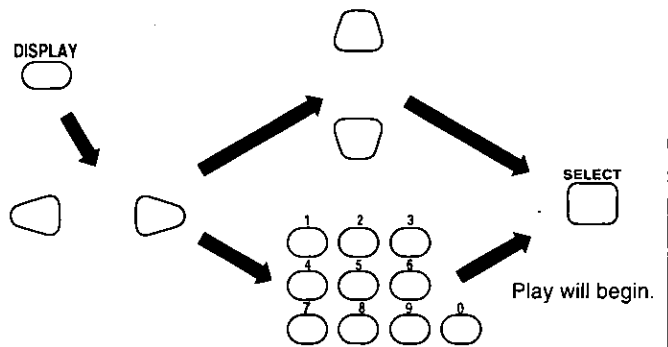

Play will begin.

To search for a position

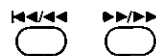

To stop play



To switch OFF the TV



To switch OFF the DVD player



Note

Turn the receiver OFF last.

Changing the remote control code SA-AX730 only

Change the remote control code in either of the following circumstances:

- If the Panasonic TV or VCR does not operate as a result of a difference in the remote control code.
- If you wish to operate some other make of TV or VCR.

(Refer to pages 34, 35 for the buttons which can be operated.)

How to change the remote control code

TV VCR

Hold down the button corresponding to the component you wish to operate.

Continue to hold the button down and...

Aim the remote control at the component you wish to operate and press the numeric buttons to enter the appropriate two-digit code number.
(Refer to the table below for the code number.)

When the two-digit code number is entered, the remote control will automatically output the on/off signal.

If the remote control has been correctly changed to the code for the component to be operated, the component will be switched ON or OFF.

Note
If there is more than one code number indicated in the code table, repeat the above procedure until you find a code number for which the power of the component is switched ON or OFF.

TV				VCR			
Manufacturer	Code No.	Manufacturer	Code No.	Manufacturer	Code No.	Manufacturer	Code No.
Panasonic	01,02,20	RCA	03,07,09,13,23	Panasonic	01,02,09,33	Philips	02,09,12
Sony	04		24,25	Sony	05,06,07,35,36	Pioneer	09
Fisher	14	Sanyo	14		37	Quasar	01,02,09,33
G-E	02,03,07,09	Sharp	08,21	Fisher	13,14,15,18	RCA	02,03,04,09,10
Gold Star	07,15	Sylvania	06,07,15	Funai	08,30		11,12,23,24,26
Hitachi	05,07	Symphonic	17	G-E	02,03,11	Sanyo	14,18
JVC	12	Toshiba	10,21	Gold Star	27	Sharp	16,17
LXI	03,06,07,10,14,15	Zenith	18,26	Hitachi	09,10,11	Shintom	32
Magnavox	06,07,11,15,22			JVC	19,25,31,38,39,40	Sylvania	02,09,12,30
Mitsubishi	07,15,16,21			LXI	10,13,14,15,18,27,30	Symphonic	30
NEC	07,15					Toshiba	23,24
Philco	06,07			Magnavox	02,09,12	Zenith	20
Philips	06			Mitsubishi	21,22,28,29		
Pioneer	02,10,19			NEC	19,25,31,38		
Quasar	02			Philco	02,09,12,30		

Note

If the remote control code is changed in accordance with the method given above, the code will be re-initialized to the Panasonic code (code 01) when the batteries are replaced. To change the code back again, repeat the operations given above.

About the HELP function

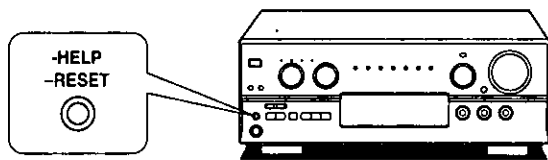

SA-AX730

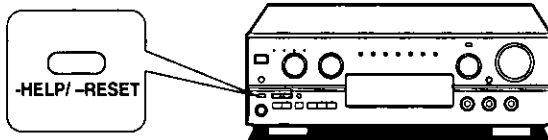

SA-AX530

If you make a mistake in operation or if sound output stops due to some operation which was performed, the HELP function displays information which can be useful for indicating the method by which this condition can be remedied.

If "ERROR" or scrolling characters (for instance, "SPEAKER OFF NOW") appear on the display during operation, carry out the following operation.

Press [-HELP/-RESET].

The method for remedying this situation will be displayed.

For your reference

If the above button is pressed for 2 seconds or more until "RESET" appears on the display, the operation settings for the unit will be initialized to the settings made at the time of shipment.

However, any broadcasting stations which have been preset into memory will not be erased at this time.

Listening caution



Selecting fine audio equipment such as the unit you've just purchased is only the start of your musical enjoyment. Now it's time to consider how you can maximize the fun and excitement your equipment offers. This manufacturer and the Electronic Industries Association's Consumer Electronics Group want you to get the most out of your equipment by playing it at a safe level. One that lets the sound come through loud and clear without annoying blaring or distortion—and, most importantly, without affecting your sensitive hearing.

We recommend you to avoid prolonged exposure to excessive noise.

Sound can be deceiving. Over time your hearing "comfort level" adapts to higher volumes of sound. So what sounds "normal" can actually be loud and harmful to your hearing.

Guard against this by setting your equipment at a safe level BEFORE your hearing adapts.

To establish a safe level:

- Start your volume control at a low setting.
- Slowly increase the sound until you can hear it comfortably and clearly, and without distortion.

Once you have established a comfortable sound level:

- Set the dial and leave it there.

Taking a minute to do this now will help to prevent hearing damage or loss in the future. After all, we want you listening for a lifetime.

Maintenance

If the surfaces are dirty

To clean this unit, wipe with a soft, dry cloth.

If the surfaces are extremely dirty, use a soft cloth dipped in a soap-and-water solution or a weak detergent solution.

- Never use alcohol, paint thinner or benzene to clean this unit.
- Before using chemically impregnated cloth, read the instructions that came with the cloth carefully.

Product Service

Do not attempt to remove the cover(s) or repair the unit yourself. Refer servicing to qualified personnel only.

Product information

For product service, product information or assistance with product operation, refer to the servicenter directory.

Before requesting service for this unit, check the chart below for a possible cause of the problem you are experiencing. Some simple checks or a minor adjustment on your part may eliminate the problem and restore proper operation.

If you are in doubt about some of the check points, or if the remedies indicated in the chart do not solve the problem, refer to the directory of Authorized Service Centers (enclosed with this unit) to locate a convenient service center, or consult your dealer for instructions.

For detailed instructions, contact an authorized servicenter in the U.S.A. and Panasonic Canada Inc. Customer Care Centre in Canada.

In the U.S.A. 1-800-211-7262 or web site

(<http://www.panasonic.com>)

In Canada 905-624-5505 or web site

(www.panasonic.ca/faq.html)

Reference pages indicated in blank circles. (For example: 29)

Problem	Probable cause(s)	Suggested remedy
---------	-------------------	------------------

While listening to FM broadcasts		
A hiss is heard during stereo broadcasts, but not during monaural ones.	Modulation for the two types is different so some noise may be heard during stereo broadcasts.	<ul style="list-style-type: none"> Reduce the treble. (29) Change the location and direction of the antenna. (12 15) Use an outdoor antenna. (13) Use an antenna with more elements.
Excessive noise in both stereo and monaural broadcasts.	Antenna location and direction poor.	<ul style="list-style-type: none"> Use an outdoor antenna. (13) Use an antenna with more elements.
	Station is distant.	
STEREO and QUARTZ LOCK indicators flicker.	Antenna location and direction poor.	<ul style="list-style-type: none"> Change the location and direction of the antenna. (12 13) Use an outdoor antenna. (13) Use an antenna with more elements.
	Station is distant.	
Stereo broadcasts highly distorted.	Building or mountain nearby.	<ul style="list-style-type: none"> Use an antenna with more elements.

While listening to AM broadcasts		
An unusual "beat" sound is heard.	A television is on nearby.	<ul style="list-style-type: none"> Separate the two or turn the television off.
	Adjacent signal is interfering.	<ul style="list-style-type: none"> Reduce the treble. (29)
A low-pitched "hum" is heard when a station is tuned.	Power cord is near the antenna wires.	<ul style="list-style-type: none"> Separate the power cord from the wires.
	Electronic interference from the power cord is fed to the speakers.	<ul style="list-style-type: none"> Use an outdoor antenna. (13)
A continuous or intermittent hiss is heard.	Interference from other appliances, fluorescent lights, TVs, small motors, etc., through discharge and oscillation.	<ul style="list-style-type: none"> Separate this unit from such appliances.

Common Problems		
Unit doesn't come on.	The power cord plug is not fully inserted.	<ul style="list-style-type: none"> Confirm the plug is fully inserted.
Sound is not heard.	The speaker indicators are off.	<ul style="list-style-type: none"> Turn on the speaker indicators. (16)
	The tape monitor function is on.	<ul style="list-style-type: none"> Press the tape monitor button. (17)
	The muting function is on.	<ul style="list-style-type: none"> Press the muting button on the remote control. (29)
	Incomplete or incorrect connection to speakers and external equipment.	<ul style="list-style-type: none"> Check all connections. (8 - 11, 14 - 15)
Sound suddenly stops or none is heard when the unit is switched on. "OVERLOAD" appears on the display.	The incorrect input source has been selected.	<ul style="list-style-type: none"> Select the correct source. (16)
	The protection circuitry has functioned because: the positive and negative speakers wires have shorted; speakers with a lower impedance than this unit's rated impedance are being used; the speakers are under strain through excessive volume, excessive power, or by being used in a high temperature environment.	<ul style="list-style-type: none"> Switch off the unit, determine and correct the cause, then switch the unit on. Use speakers with the right impedance rating. (14 - 15)

■ AMPLIFIER SECTION

Rated minimum sine wave RMS power output	
40 Hz–20 kHz both channels driven	80 W per channel (8 Ω)
0.8% total harmonic distortion	
1 kHz continuous power output both channels driven	
0.05% total harmonic distortion	83 W per channel (8 Ω)
Total harmonic distortion	
rated power at 40 Hz–20 kHz	0.8% (8 Ω)
half power at 1 kHz	0.07% (8 Ω)
Power output at the Dolby Pro Logic operation	
0.9% at 1 kHz,	
Front	2×80 W (8 Ω)
Center	80 W (8 Ω)
Surround	2×80 W (8 Ω)
Low frequency damping factor	
	30 (8 Ω)
Load impedance	
Front	8 Ω
Center	8 Ω
Surround	8 Ω
Frequency response	
PHONO	RIAA standard curve ±0.8 dB
CD, TAPE, DVD, VCR, TV/DSS	10 Hz–70 kHz, ±3 dB
Input sensitivity	
PHONO	0.4 mV (3 mV, IHF '66)
CD, TAPE, DVD, VCR, TV/DSS	27 mV (200 mV, IHF '66)
S/N (IHF A)	
PHONO	70 dB (78 dB, IHF '66)
CD, TAPE, DVD, VCR, TV/DSS	75 dB (83 dB, IHF '66)
Input impedance	
PHONO	47 kΩ
CD, TAPE, DVD, VCR, TV/DSS	22 kΩ
Tone controls	
BASS	50 Hz, +10 to –10 dB
TREBLE	20 kHz, +10 to –10 dB
Subwoofer frequency response	7–100 Hz, ±3 dB

■ FM TUNER SECTION

Frequency range	87.9–107.9 MHz
Sensitivity	11.2 dBf (2 μV, IHF '58)
50 dB quieting sensitivity	
MONO	18.3 dBf (4.5 μV, IHF '58)
STEREO	38.3 dBf (45 μV, IHF '58)
Total harmonic distortion	
MONO	0.2%
STEREO	0.3%
S/N	
MONO	73 dB
STEREO	67 dB
Frequency response	20 Hz–15 kHz, +1 dB, –2 dB
Alternate channel selectivity	65 dB
Capture ratio	1.5 dB
Image rejection at 98 MHz	40 dB
Spurious response rejection at 98 MHz	75 dB
AM suppression	50 dB
Stereo separation	
1 kHz	40 dB
10 kHz	30 dB
Antenna terminal	75 Ω (unbalanced)

■ AM TUNER SECTION

Frequency range	530–1710 kHz
Sensitivity	20 μV, 330 μV/m
Selectivity	55 dB
IF rejection at 1000 kHz	50 dB

■ VIDEO SECTION

Output voltage at 1 V input (unbalanced)	1±0.1 Vp-p
Maximum input voltage	1.5 Vp-p
Input/output impedance	75 Ω

■ GENERAL

Power supply	AC 120 V, 60 Hz
Power consumption	345 VA, 270 W (In standby condition: 1 W)
Dimensions (W×H×D)	
430×136×320.6 mm (16-15/16"×5-11/32"×12-5/8")	
Weight	8.5 kg (18.87 lb.)

Notes:

- Specifications are subject to change without notice. Weight and dimensions are approximate.
- Total harmonic distortion is measured by the digital spectrum analyzer.